

## Nationale Hinterlegungen

In der folgenden Liste werden die beim Eidgenössischen Institut für Geistiges Eigentum hinterlegten Designs publiziert. Dabei sind der Reihe nach angegeben:

- internationale Klassenangaben
- Hinterlegungsnummer
- Hinterlegungsdatum
- Allenfalls Aufschub der Veröffentlichung
- Anzahl der hinterlegten Designs
- Bezeichnung
- Name und Wohnsitz des Hinterlegers oder der Hinterlegerin
- gegebenenfalls Name und Wohnsitz des Designers oder der Designerin
- Name und Geschäftssitz des allfälligen Vertreters oder der Vertreterin
- gegebenenfalls Prioritätsangaben
- gegebenenfalls Beschreibungstext
- Ordnungsnummer
- Reproduktion des Designs

## Internationale Hinterlegungen

Die bei der Weltorganisation für geistiges Eigentum in Genf hinterlegten Muster und Modelle mit Benennung Schweiz geniessen den gleichen Schutz wie national hinterlegte Designs. Sie werden jeweils im Blatt «Bulletin des dessins et modèles internationaux» veröffentlicht. Dieses Publikationsorgan ist deshalb für eine vollständige Recherche unbedingt beizuziehen.

## Topographien

Angaben über die vom Eidgenössischen Institut für Geistiges Eigentum eingetragenen Topographien von Halbleitererzeugnissen werden in folgender Anordnung aufgeführt:

- Eintragsnummer
- Anmeldedatum
- Bezeichnung
- Name und Wohnsitz des Anmelders oder der Anmelderin
- gegebenenfalls Name und Wohnsitz des Herstellers oder der Herstellerin
- Name und Geschäftssitz des oder der allfälligen Bevollmächtigten
- Datum und Ort einer allfälligen ersten geschäftlichen Verbreitung der Topographie

## Dépôts nationaux

Les designs déposés à l'Institut Fédéral de la Propriété Intellectuelle sont publiés dans la liste qui suit. Les indications y relatives sont mentionnées dans cet ordre:

- indications des classes internationales
- numéro de dépôt
- date de dépôt
- le cas échéant, ajournement de la publication
- nombre des designs déposés
- désignation
- nom et domicile du/de la déposant/e
- le cas échéant, nom et domicile du/de la designer
- nom et domicile de l'éventuel/le mandataire
- le cas échéant, indication de priorité
- le cas échéant, description du design
- numéro attribué à chaque design
- reproduction du design

## Dépôts internationaux

Les dessins et modèles déposés à l'Organisation Mondiale de la Propriété Intellectuelle à Genève qui désignent la Suisse jouissent de la même protection que les dépôts nationaux. Ils sont chaque fois publiés dans la feuille «Bulletin des dessins et modèles internationaux». Pour une recherche complète, il est indispensable de consulter ledit organe de publication.

## Topographies

Les indications concernant les topographies des produits semi-conducteurs, enregistrées par l'Institut Fédéral de la Propriété Intellectuelle, sont énumérées dans l'ordre suivant:

- numéro d'enregistrement
- date de dépôt
- désignation
- nom et domicile du/de la déposant/e
- le cas échéant, nom et domicile du/de la producteur/trice
- nom et domicile de l'éventuel/le mandataire
- date et lieu d'une éventuelle première mise en circulation de la topographie

## Depositi nazionali

Nella lista seguente vengono pubblicati i design depositati presso l'Istituto Federale della Proprietà Intellettuale. Sono menzionati nel seguente ordine:

- indicazioni delle classi internazionali
- numero di deposito
- data del deposito
- se del caso, indicazione che la pubblicazione è stata differita
- numero dei design depositati
- designazione
- nome e domicilio del depositante
- se del caso, nome e domicilio del designer
- nome e sede di un eventuale mandataro
- se del caso, indicazioni di priorità
- se del caso, descrizione del design
- numero d'ordine
- riproduzione del design

## Depositi internazionali

I disegni e modelli depositati presso l'Organizzazione Mondiale della Proprietà Intellettuale a Ginevra con denominazione Svizzera godono della medesima protezione del deposito nazionale. Essi vengono pubblicati ogni volta nel foglio «Bulletin des dessins et modèles internationaux». Quest'organo di pubblicazione è da consultare se si vuole effettuare una ricerca completa.

## Topografie

Le indicazioni concernenti le topografie di prodotti a semiconduttori depositati presso l'Istituto Federale della Proprietà Intellettuale sono menzionate nell'ordine seguente:

- numero di registrazione
- data del deposito
- designazione
- nome e domicilio del/la richiedente
- se del caso, nome e domicilio del/la produttore/trice
- nome e sede di un eventuale mandataro
- data e luogo di un'eventuale prima messa in circolazione della topografia

**Hinterlegungen  
Dépôts  
Deposit**

Cl. 10-07 132 665 21.03.2006

1 design – montre  
Déposant: Audemars Piguet (Marketing) SA,  
route de France 16, 1348 Le Brassus  
Designer: Octavio Garcia, Cressier  
Mandataire: Bugnion S.A., 1211 Genève 12 - Champel  
Fin de la période ajournement de la publication

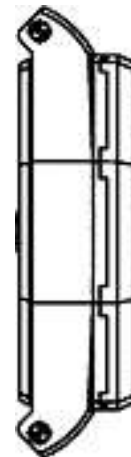
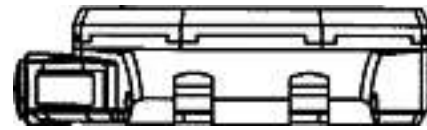
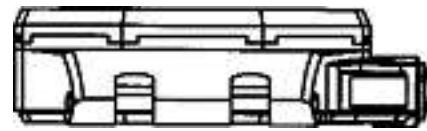
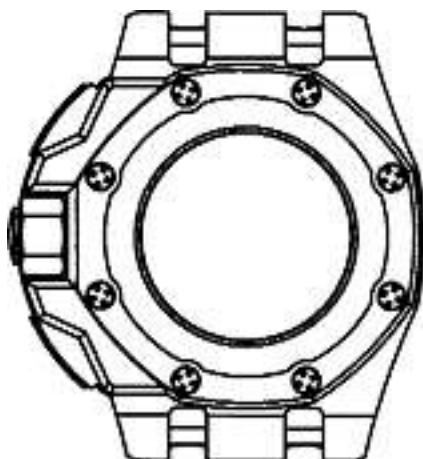
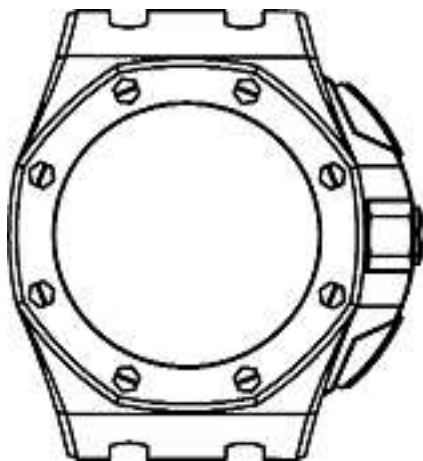
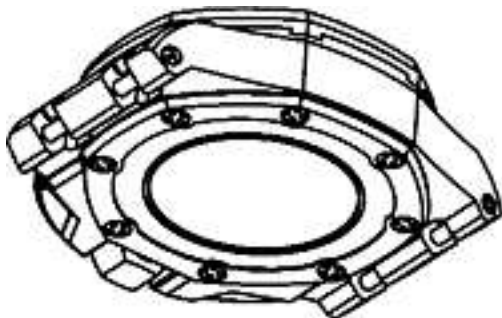
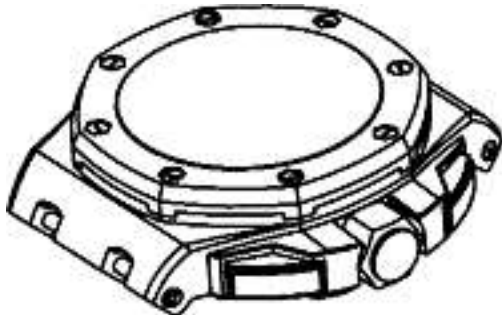

1

Cl. 01-01 134 143 27.06.2007

1 Design – Glace  
Hinterleger: Wander AG, Fabrikstrasse 10, 3176 Neuenegg  
Designer: Beatrice Müller, Thayngen; Björn Roncoroni, Bern  
Beschreibung des Designs: Die Form soll dem Produktnamen  
"OVO" so gut wie möglich gerecht werden. Da ein "O V O"  
aus technischen Gründen nicht machbar ist, wird die Form  
auf "OO" festgelegt, welches die "O" aus dem Wort "OVO"  
repräsentieren. Die Form kennzeichnet sich durch die beson-  
dere Oberflächenstruktur, welche nicht einheitlich und glatt  
ist, sondern die Struktur von zerkleinertem Ovo-Granulat und  
farbliche Aufhellungen aufweist.





OVO-Crunchy Ice Cream

Cl. 01-01                      **134 144**                      18.07.2007  
 3 design – chocolat  
 Déposant: Société des Produits Nestlé SA, , 1800 Vevey  
 Designer: Thierry Martin, York  
 Mandataire: Nestec S.A., 1800 Vevey

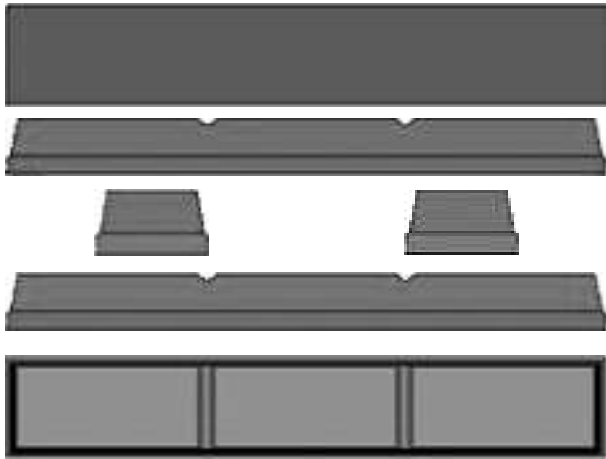

FL 66525/1



FL 66525/2





FL 66525/3

Cl. 02-02 **134 148** 02.07.2007

1 design – tee-shirt

Déposant: Au Fil des Mois, Josette Dussex,  
Rue des Remparts 14, 1950 Sion

Designer: Josette Dussex, Leytron

Description du design: Tee-shirt spécial pour future maman confectionné avec un arrondi sur le devant au fond du tee-shirt cintré au dos.



1

Cl. 03-01 **134 149** 04.07.2007

2 Design – Taschen- und Etuibemusterungen

Hinterleger: Oskar Debrunner AG, Dunantstrasse 12,  
8570 Weinfelden

Designer: Thomas Debrunner, Weinfelden



91.20361 Delfin



91.20367 Dream

Cl. 03-01 **134 150** 11.07.2007

2 Design – Taschen- und Etuibemusterungen

Hinterleger: Oskar Debrunner AG, Dunantstrasse 12,  
8570 Weinfelden

Designer: Thomas Debrunner, Weinfelden



91.20364 Kicker



91.20370 Robo

Cl. 05-06 **134 151** 18.07.2007

1 design – décor pour papier  
Déposant: Georgia-Pacific France, 11, route Industrielle,  
68320 Kunheim, FR

Designer: Mark Smolders, Amsterdam  
Mandataire: MICHELI & CIE SA, 1226 Thônex  
Priorité: EM, 24.01.2007  
15054A (siehe Farbteil Heftmitte)

Cl. 05-06 **134 152** 18.07.2007

1 design – motif pour papier  
Déposant: Georgia-Pacific France, 11, route Industrielle,  
68320 Kunheim, FR  
Designer: Pierre Graff, Wolfgangtzen; Jean-Bernard Kuehn,  
Bennwihr; Sébastien Jeannot, Holtzwihr  
Mandataire: MICHELI & CIE SA, 1226 Thônex  
Priorité: EM, 01.02.2007



15051A

Cl. 06-01, 06-03 **134 153** 18.05.2007

8 Design – Möbel

Hinterleger: Dedon GmbH, Zeppelinstrasse 22,  
21337 Lüneburg, DE

Designer: Nicolas Thomkins, Lüneburg

Vertreter: Troesch Scheidegger Werner AG, 8126 Zumikon

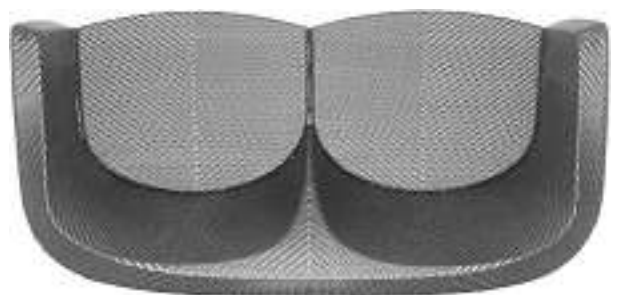



1

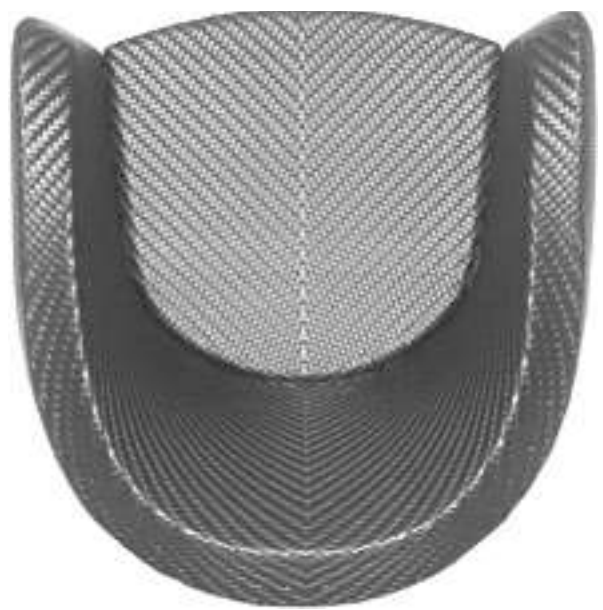

2

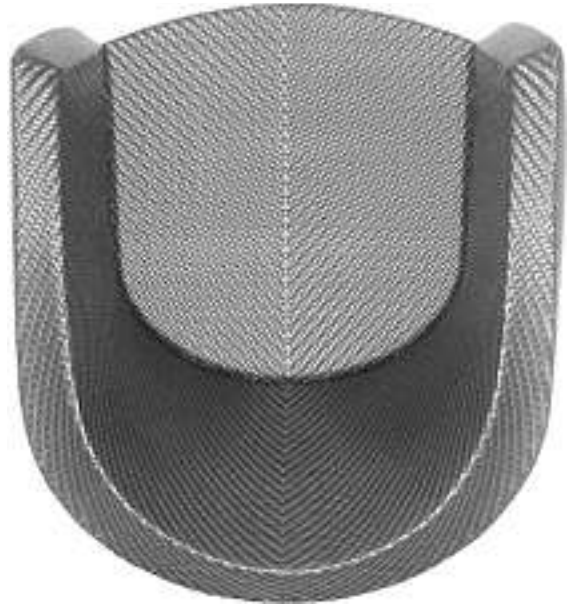

3

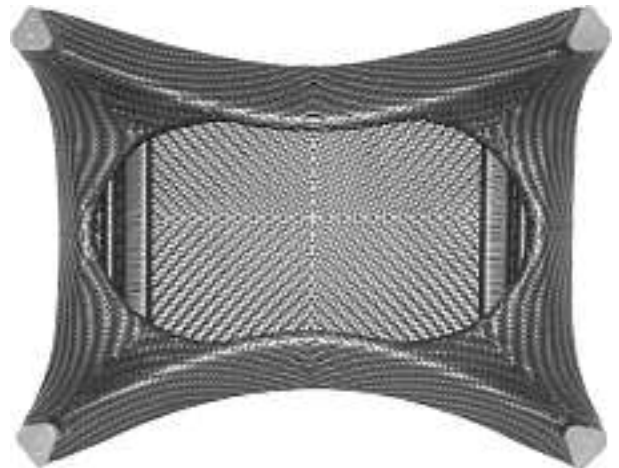

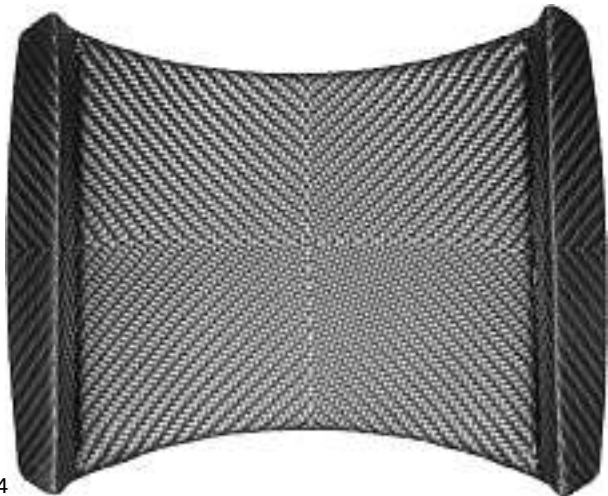
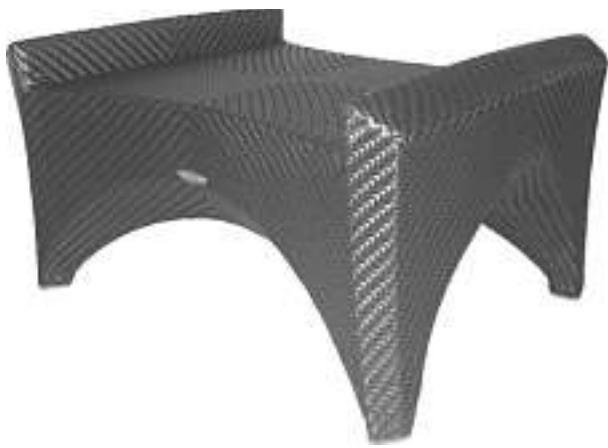

4

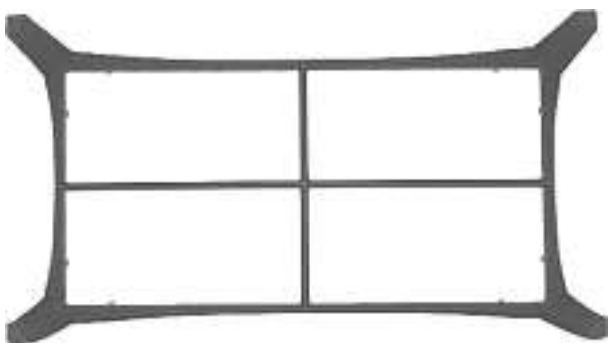

5

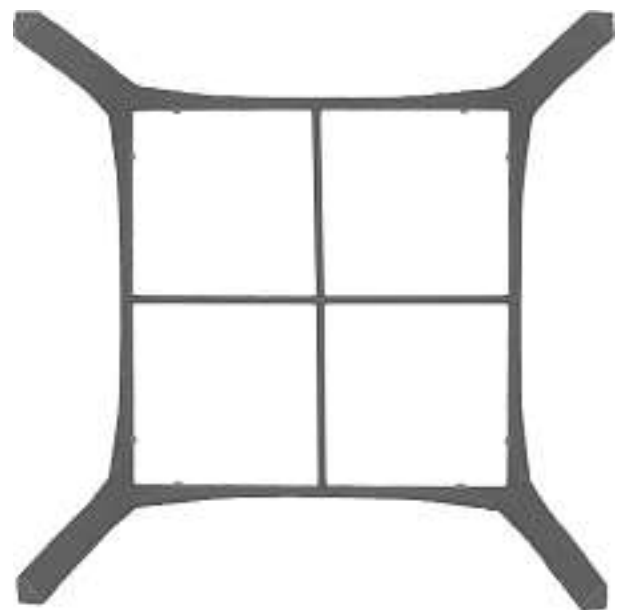





6

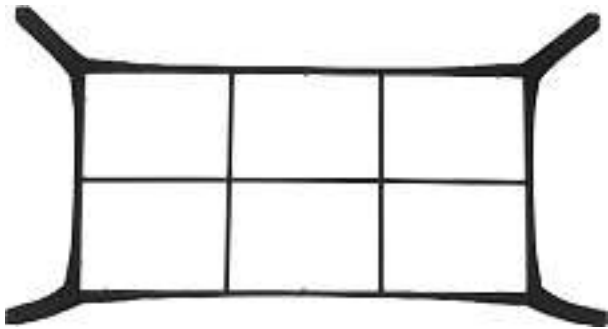

7





8

Cl. 06-01, 06-02 134 154 13.07.2007  
 2 Design – Bett, Sofa  
 Hinterleger: Andreas Benedikt Bächtiger, Elfenaustrasse 33,  
 6005 Luzern

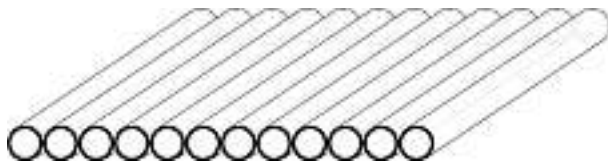

rl\_001

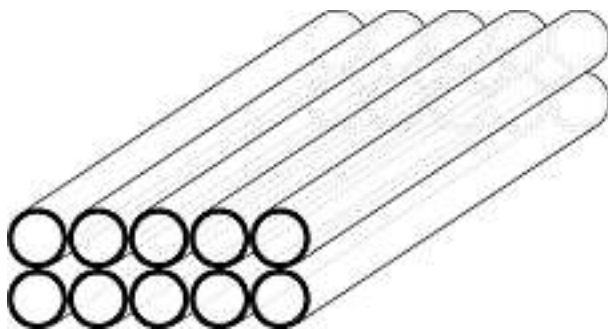

rl\_002

Cl. 06-03, 06-04 134 155 23.07.2007  
 2 Design – Vitrine, Stehtisch  
 Hinterleger: Arbeitsgemeinschaft Roger Brunner, Eugen  
 Eisenhut, Stephan Gisi, c/o Eisenhut Architekten AG,  
 Letziggraben 114, 8047 Zürich  
 Designer: Roger Brunner, Zürich; Eugen Eisenhut, Zürich;  
 Stephan Gisi, Uster

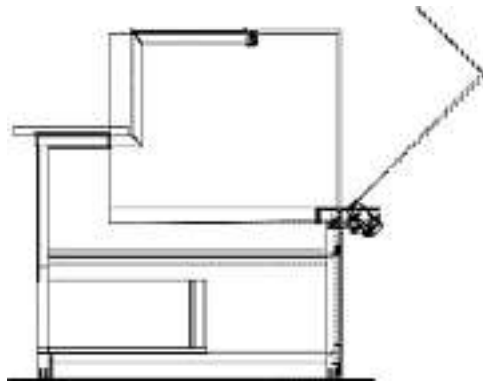
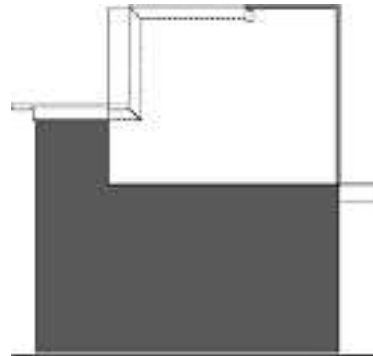
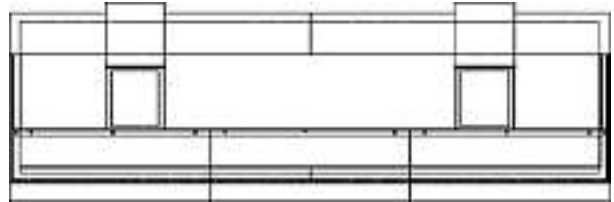

0.13Vitrine

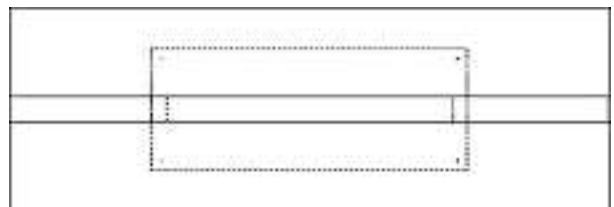
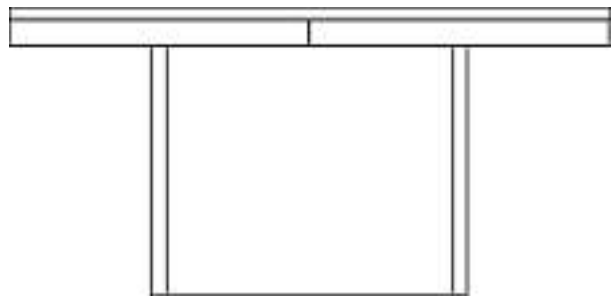

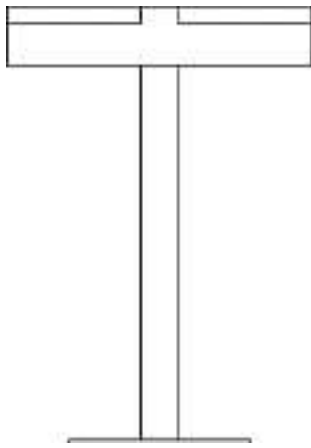

0.14 Stehtisch

Cl. 06-04                      **134 156**                      09.07.2007  
 8 Design – Badezimmermöbel  
 Hinterleger: Erwin Müller GmbH, Breslauer Strasse 34-38,  
 49808 Lingen (Ems), DE  
 Designer: Ulrich Finkeldey, Bielefeld; Kai Uetrecht, Bielefeld  
 Vertreter: Schneider Feldmann AG, Patent- und  
 Markenanwälte, 8022 Zürich  
 Priorität: EM, 13.02.2007; EM, 05.03.2007



3



4



1



2



5

6



Cl. 06-04 **134 157** 20.07.2007  
 1 Design – Regal  
 Hinterleger: Bruno Messerli, Hauptstrasse 106, 4587 Aetingen  
 Rollin-RollOut (siehe Farbteil Heftmitte)

Cl. 06-06 **134 158** 18.07.2007  
 1 Design – Pokertisch-Einlage  
 Hinterleger: Dominique Stalder, Backofengasse 16,  
 9493 Mauren, LI; Jürgen Hertkorn, Schwarzenbergstrasse 81,  
 89081 Ulm, DE  
 Vertreter: Ambros Walser, 7310 Bad Ragaz



7200701

7



Cl. 07-01 **134 159** 19.06.2007  
 24 Design – Geschirr, Tassen, Untertassen, Kännchen, Teller  
 Hinterleger: Erste Bayreuther Porzellanfabrik Walküre,  
 Siegmund Paul Meyer GmbH, Gravenreutherstrasse 5,  
 Bayreuth, DE  
 Designer: Daniel Eltner, Erlangen  
 Vertreter: Schürmann & Partner, 8002 Zürich  
 Priorität: EM, 30.04.2007



8





1



2

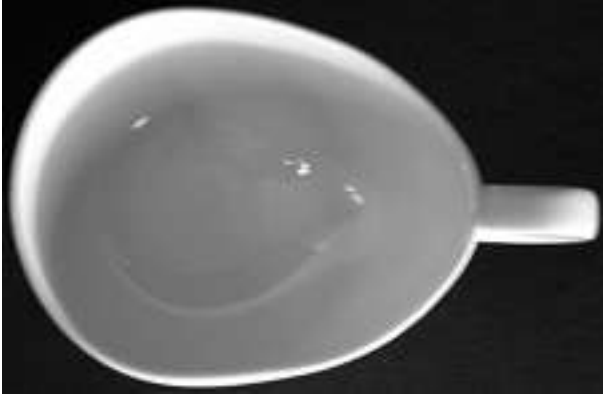



3





4

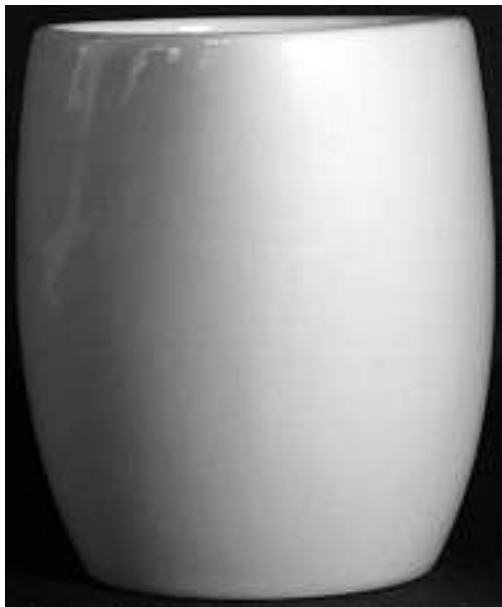

5



6

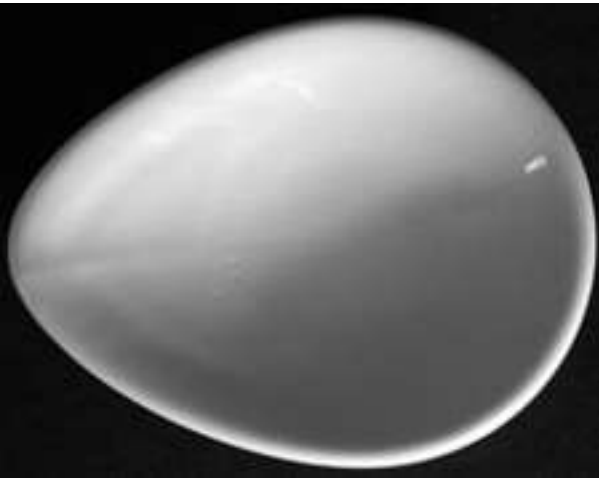
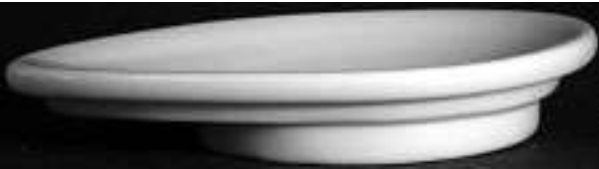

7







8



9







12





13



14





15



17



16

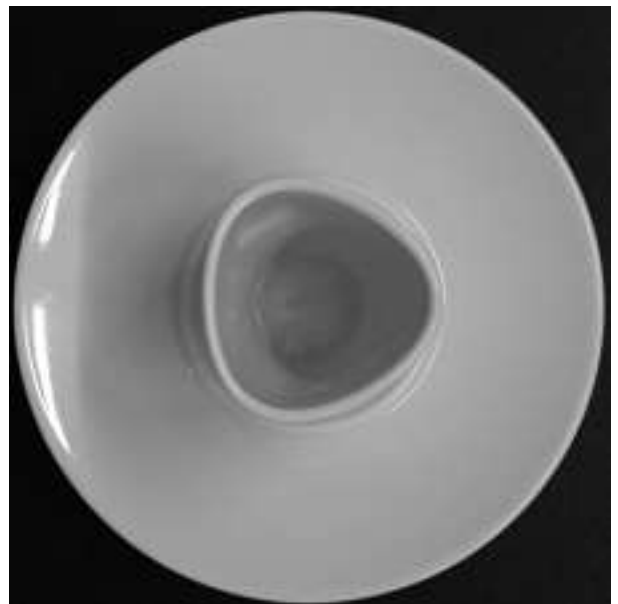



18



19





20





21



22

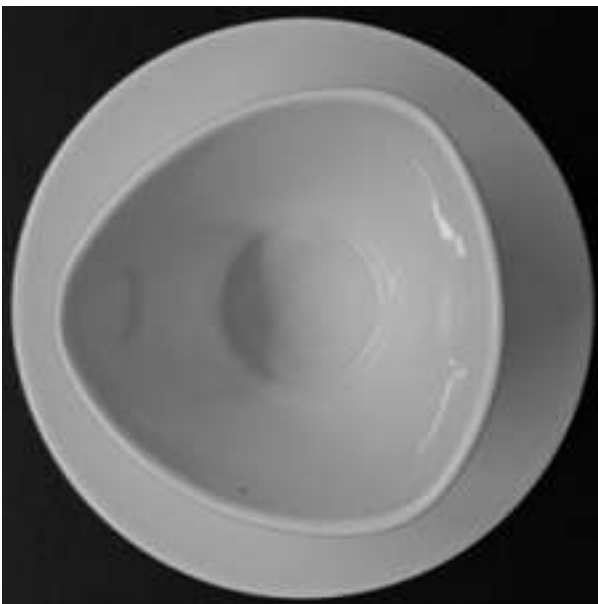





23



24

Cl. 07-01 **134 160** 17.08.2007  
 8 design – seau à glace, seau à glace et gobelets  
 Déposant: Creatives SA, rue des Tilleuls 2, 1800 Vevey  
 Designer: Erol Toker, Rolle; Philippe Vallat, Crissier  
 Mandataire: TRADAMARCA, George W. Humphrey,  
 1001 Lausanne

- 1 (siehe Farbteil Heftmitte)
- 2 (siehe Farbteil Heftmitte)
- 3 (siehe Farbteil Heftmitte)
- 4 (siehe Farbteil Heftmitte)
- 5 (siehe Farbteil Heftmitte)
- 6 (siehe Farbteil Heftmitte)
- 7 (siehe Farbteil Heftmitte)
- 8 (siehe Farbteil Heftmitte)

Cl. 07-02 **134 161** 09.07.2007

1 Design – Grill

Hinterleger: Reto Müller, Tannenstrasse 5, 6245 Ebersecken



Gartengrill Nr. 1

Cl. 07-02 **134 162** 17.08.2007

3 Design – Filter

Hinterleger: Dripco AG, Hafenstrasse 50A, 8280 Kreuzlingen

Designer: Christian von Dein, Kreuzlingen

Vertreter: Patentanwalt Dipl.-Ing. ETH Heinz R. Werffeli,  
 8125 Zollikerberg

Priorität: EM, 15.06.2007

1 (siehe Farbteil Heftmitte)

2 (siehe Farbteil Heftmitte)

3 (siehe Farbteil Heftmitte)

Cl. 07-03 134 163 12.07.2007  
 1 Design – Messergriff  
 Hinterleger: Hans-Gerd Josten, Schützenstrasse 14, 3097 Liebefeld



jo2007-2

Cl. 07-05 134 164 09.08.2007  
 2 Design – Desinfektionsgerät  
 Hinterleger: Smart Fiber AG, Prof.-Hermann-Klare-Strasse 23, 07407 Rudolstadt, DE  
 Designer: Bernhard Schablinger, Schwanenstadt  
 Vertreter: Luchs & Partner, Patentanwälte, 8002 Zürich  
 Priorität: EM, 28.02.2007  
 1 (siehe Farbteil Heftmitte)  
 2 (siehe Farbteil Heftmitte)

Cl. 07-99 134 165 11.07.2007  
 2 Design – Serviertabletts  
 Hinterleger: MATRIX Design Fabia Zindel, Bachlettenstrasse 10, 4054 Basel  
 Designer: Fabia Zindel, Basel



matrix\_tablett\_gross

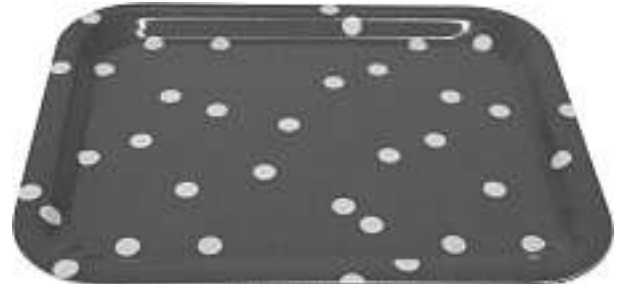

matrix\_tablett\_klein

Cl. 07-99 134 166 19.07.2007  
 1 Design – Tablett  
 Hinterleger: Christoph Schmäh, Geerenstrasse 7H, 8604 Volketswil

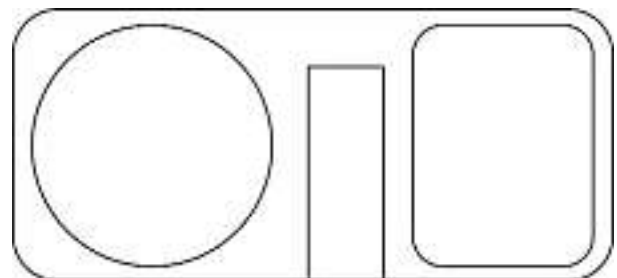

Apero-Butler

Cl. 08-01 134 167 17.07.2007  
 1 Design – Anfas-/Entgratungswerkzeug  
 Hinterleger: Falcom Inc., 4-6, Mitsugaoka 2-chome, Nishi-ku, Kobe-shi, Hyogo 651-2228, JP  
 Designer: Osamu Yanagimoto, Kobe-shi  
 Vertreter: Rottmann, Zimmermann + Partner AG, 8052 Zürich  
 Priorität: JP, 02.04.2007

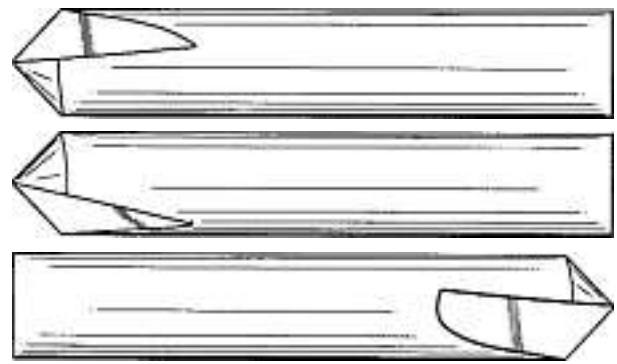
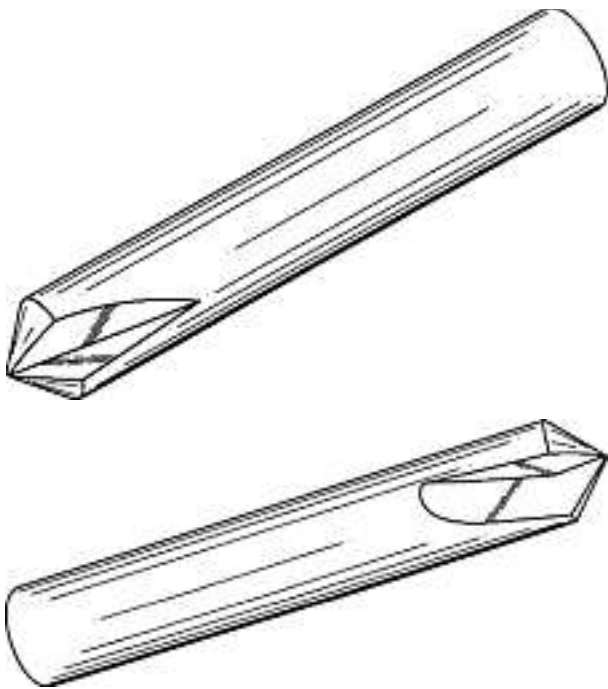

1

Cl. 08-03 134 168 12.07.2007

4 design – séateurs

Déposant: Flisch Holding S.A., Rue des Mèlèzes 4,  
2206 Les Geneveys-sur-Coffrane

Designer: Paolo Fancelli, Zürich

Mandataire: Bovard AG, 3000 Bern 25

Description du design: La couleur grise apparaissant sur les  
designs en couleurs représente la couleur de l'acier.

1 (siehe Farbteil Heftmitte)

2 (siehe Farbteil Heftmitte)

3 (siehe Farbteil Heftmitte)

4 (siehe Farbteil Heftmitte)

Cl. 09-01 134 169 28.06.2007

1 design – bouteille

Déposant: Crema S.A., 6, route de Moncor,  
1752 Villars-sur-Glâne

Designer: Arno Giesinger, Hard

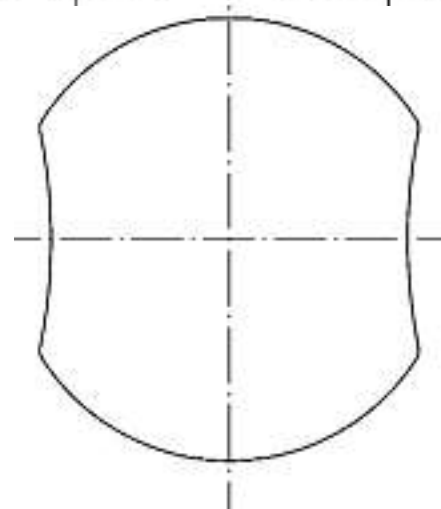
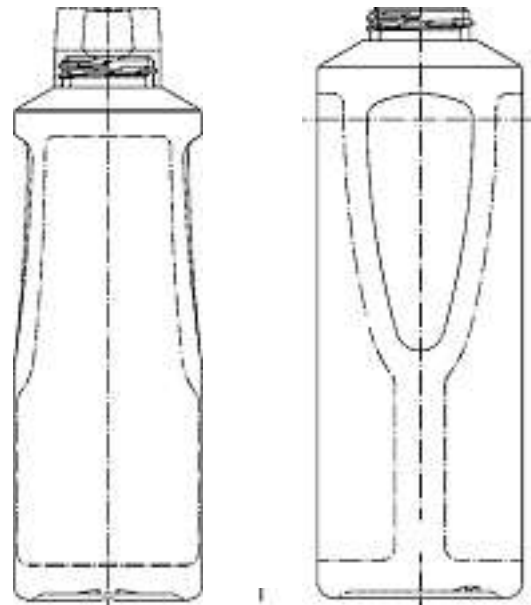
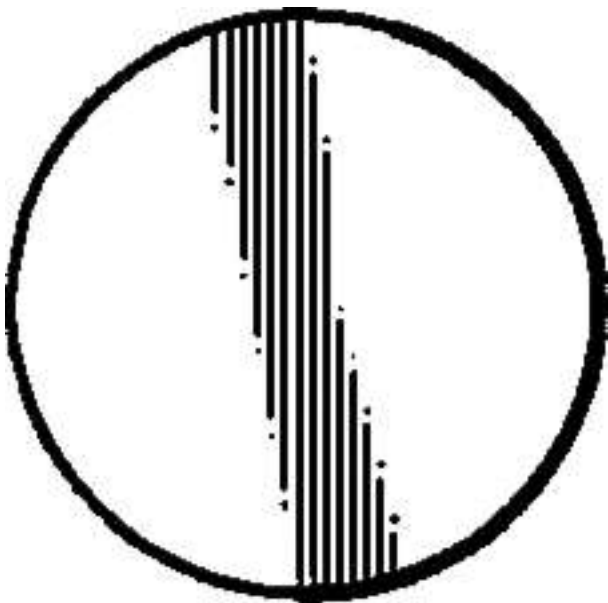
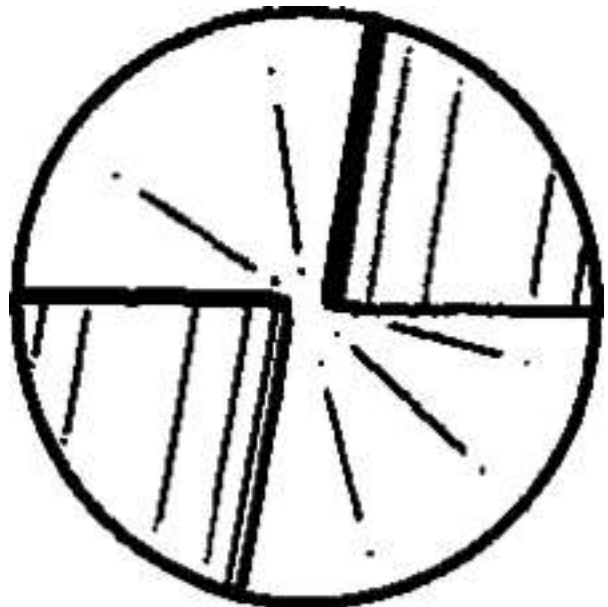

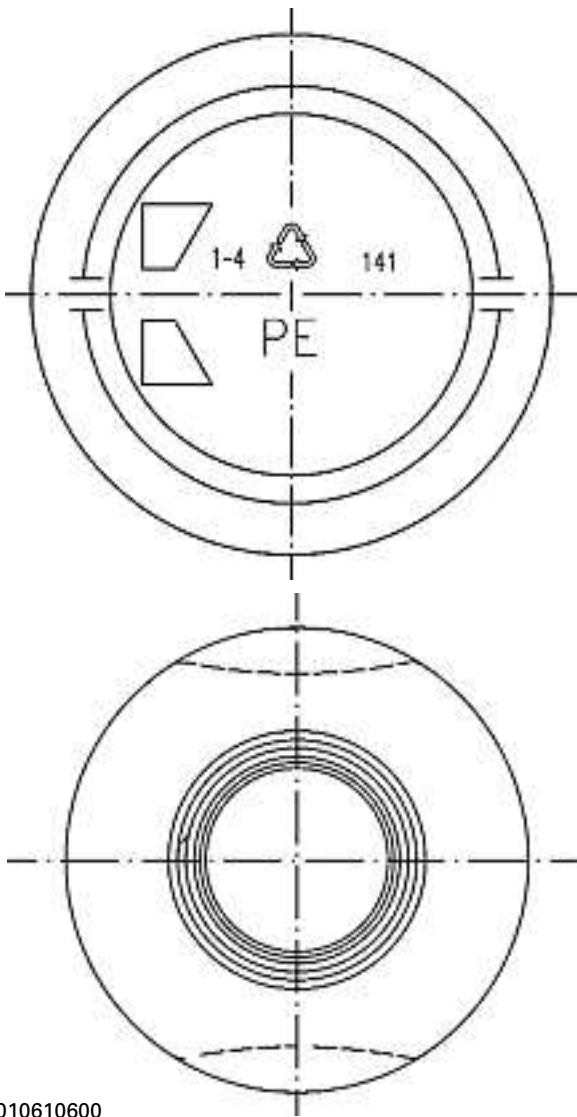

9010610600

Cl. 09-03 134 170 21.06.2007  
 5 design – fresques  
 Déposant: Guignard desserts Orbe S.A., Grand-Rue 17-19,  
 1350 Orbe  
 Designer: Caroline Mesple Moser, Lausanne  
 Mandataire: MOSER DESIGN SA, 1006 Lausanne



2

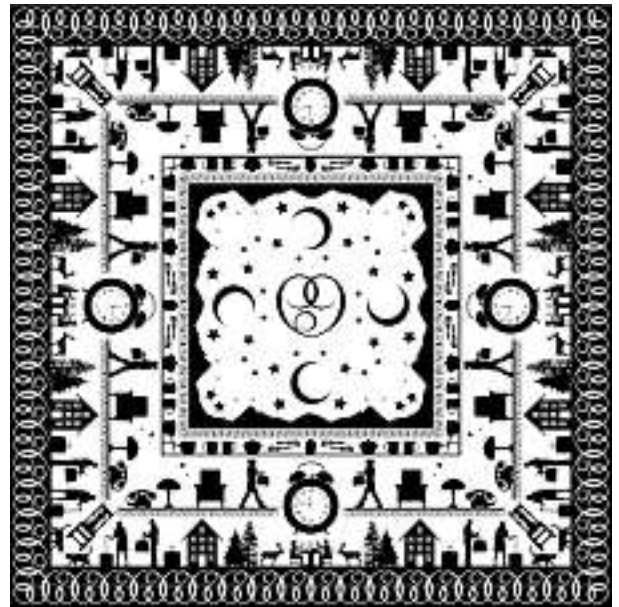

3



1



4

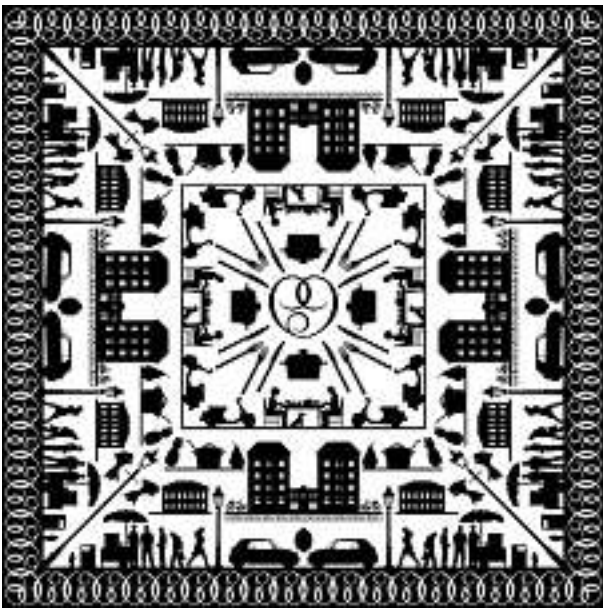

5

Cl. 09-07                      **134 171**                      04.07.2007  
 1 Design – Bedienteil einer Spraydose  
 Hinterleger: WD-40 Company, 1061 Cudahy Place,  
 San Diego (CA 92110), US  
 Designer: Gad Shaanan, La Jolla; Francois Duval, St. Laurent;  
 Ivan Brousseau, Montreal  
 Vertreter: Schneider Feldmann AG, Patent- und  
 Markenanwälte, 8022 Zürich  
 Priorität: US, 04.01.2007

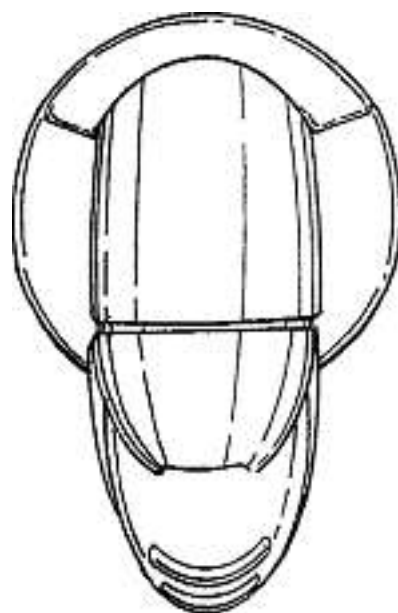
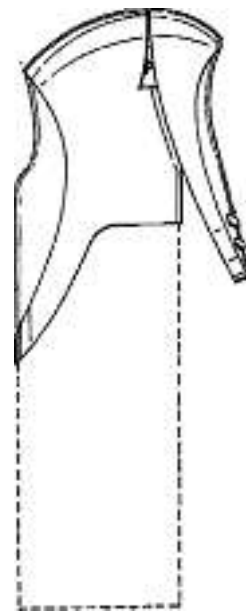
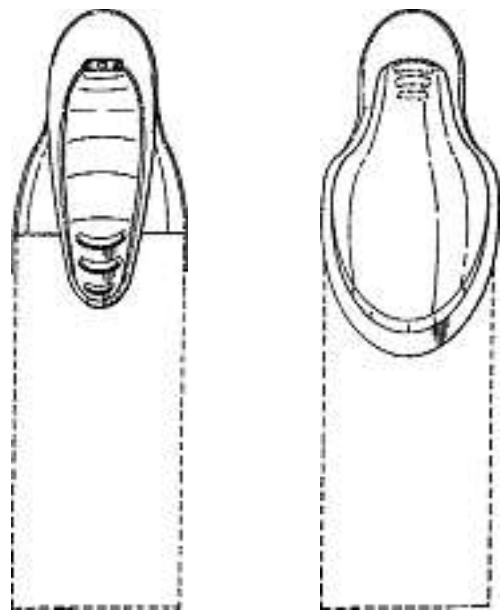
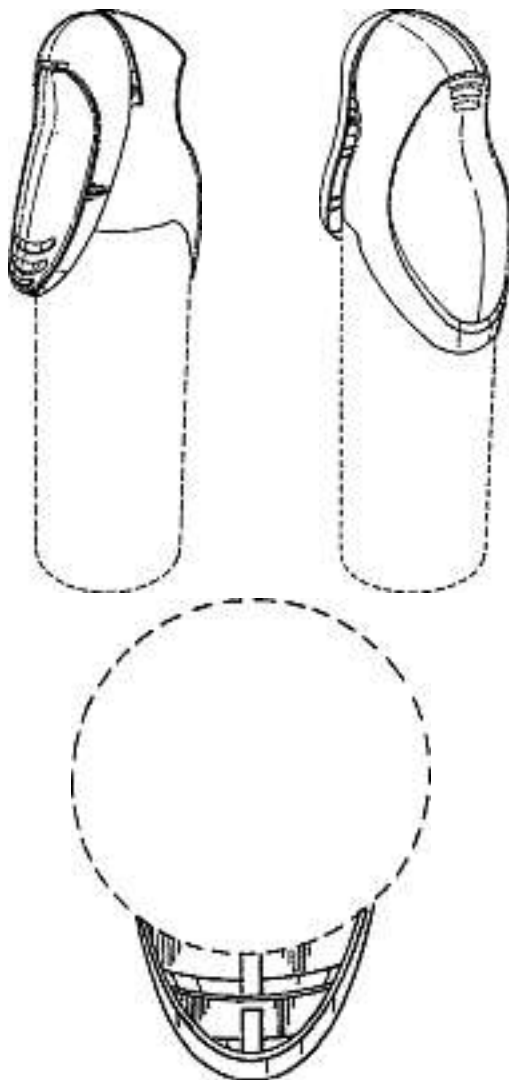

1

Cl. 09-09 134 172 09.07.2007  
 1 Design – Abfallbehälter  
 Hinterleger: Rainer Bussmann, Röschibachsteig 6, 8037 Zürich



kargalu01

Cl. 10-02 134 173 10.07.2007  
 1 Design – Armbanduhr  
 Hinterleger: Matthias Mollet, Mattenhofstrasse 22, 3007 Bern;  
 Timo Kolb, Beethovenstrasse 18, 3073 Gümligen  
 Vertreter: Matthias Mollet, 3007 Bern





1

Cl. 10-04                      **134 174**                      26.06.2007  
 10 Design – Messinstrumente  
 Hinterleger: SOLA-Messwerkzeuge GmbH, Unteres Tobel 25,  
 6840 Götzis, AT  
 Designer: Wolfgang Scheyer, Götzis  
 Vertreter: Luchs & Partner, Patentanwälte, 8002 Zürich  
 Priorität: EM, 04.01.2007



1





2







3









7





8









10



1

Cl. 10-05 134 175 19.07.2007  
7 Design – Steuergeräte  
Hinterleger: Adhoco AG, Technopark, Jägerstrasse 2,  
8406 Winterthur  
Designer: Wolfgang Meyer-Hayoz, Winterthur  
Vertreter: Advokaturbüro Beutler Künzi Stutz, 3000 Bern 6







3

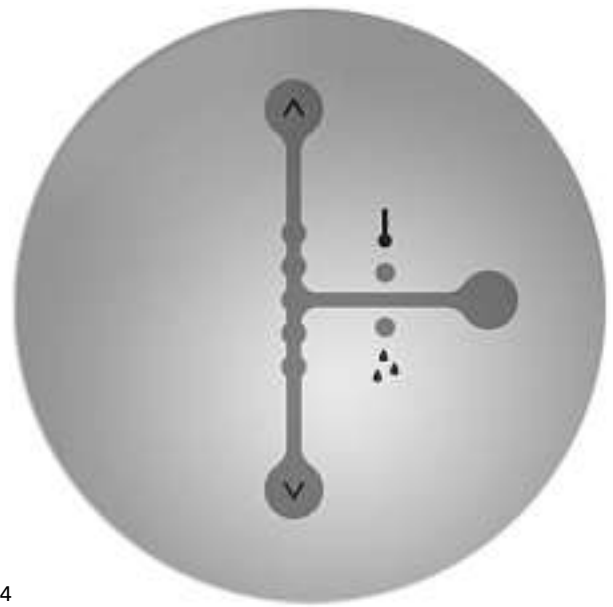

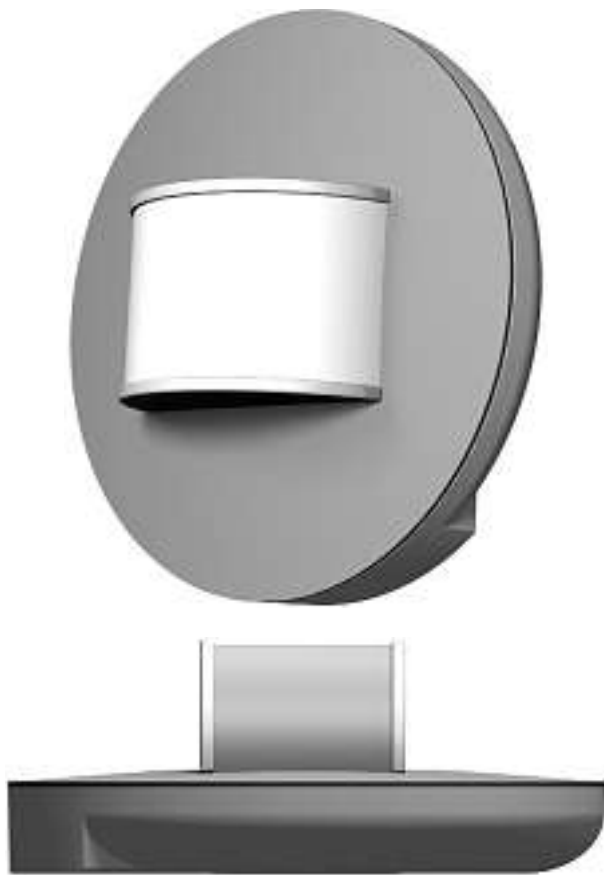

5



6

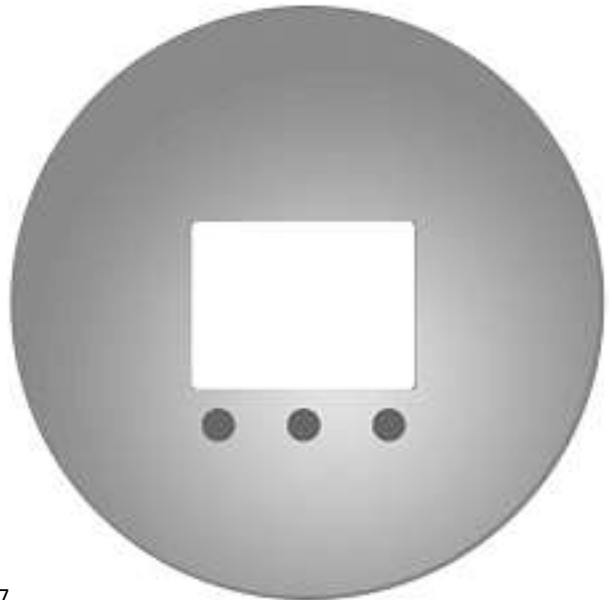

7

Cl. 12-06 134 176 12.07.2007  
1 Design – Wasserfahrzeug  
Hinterleger: Ulrich Gertsch, Ziegeleistrasse 32c, Postfach 54,  
3612 Steffisburg

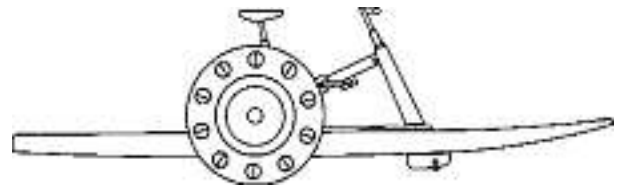

270507

Cl. 12-11 **134 179** 11.07.2007  
 4 Design – Fahrradrahmen und Teile  
 Hinterleger: Cycleurope Sverige AB, Birger Svenssons väg 28,  
 432 82 Varberg, SE  
 Designer: Ulrika Carlberg, Göteborg; Ulrik Bengtsson,  
 Varberg  
 Vertreter: Werner Bruderer, Patentanwalt, 8330 Pfäffikon ZH  
 Priorität: EM, 26.01.2007; EM, 26.01.2007; EM, 26.01.2007;  
 EM, 26.01.2007  
 C11CHMO-1.1 (siehe Farbteil Heftmitte)  
 C11CHMO-2.1 (siehe Farbteil Heftmitte)  
 C11CHMO-3.1 (siehe Farbteil Heftmitte)  
 C11CHMO-4.1 (siehe Farbteil Heftmitte)

Cl. 12-16 **134 180** 26.07.2007  
 1 Design – Auto-Sonnenschutz  
 Hinterleger: Blue Spirit Communications AG, Ifangstrasse 3,  
 8952 Schlieren  
 Designer: Gerry Flückiger, Nänikon  
 Sunshade (siehe Farbteil Heftmitte)

Cl. 13-03 **134 182** 19.07.2007  
 28 Design – elektrische Schalter  
 Hinterleger: AIZO AG, Garbenheimer Strasse 30-38,  
 35578 Wetzlar, DE  
 Designer: Wilfried Beck, Wiesbaden  
 Vertreter: Braunpat Braun Eder AG, 4054 Basel  
 Priorität: EM, 16.07.2007  
 Beschreibung des Designs: Die Schalter aller Muster haben  
 ein zentrales Leuchtelement, insbesondere eine rgb-LED, die  
 in den in den Mustern gezeigten Farben oder Mischungen  
 leuchten kann. Dabei kann die jeweils gezeigte Farbe auch  
 heller oder dunkler dargestellt sein.  
 1 (siehe Farbteil Heftmitte)  
 2 (siehe Farbteil Heftmitte)  
 3 (siehe Farbteil Heftmitte)  
 4 (siehe Farbteil Heftmitte)  
 5 (siehe Farbteil Heftmitte)  
 6 (siehe Farbteil Heftmitte)  
 7 (siehe Farbteil Heftmitte)  
 8 (siehe Farbteil Heftmitte)  
 9 (siehe Farbteil Heftmitte)  
 10 (siehe Farbteil Heftmitte)  
 11 (siehe Farbteil Heftmitte)  
 12 (siehe Farbteil Heftmitte)  
 13 (siehe Farbteil Heftmitte)  
 14 (siehe Farbteil Heftmitte)  
 15 (siehe Farbteil Heftmitte)  
 16 (siehe Farbteil Heftmitte)  
 17 (siehe Farbteil Heftmitte)  
 18 (siehe Farbteil Heftmitte)  
 19 (siehe Farbteil Heftmitte)  
 20 (siehe Farbteil Heftmitte)  
 21 (siehe Farbteil Heftmitte)  
 22 (siehe Farbteil Heftmitte)  
 23 (siehe Farbteil Heftmitte)  
 24 (siehe Farbteil Heftmitte)  
 25 (siehe Farbteil Heftmitte)  
 26 (siehe Farbteil Heftmitte)  
 27 (siehe Farbteil Heftmitte)  
 28 (siehe Farbteil Heftmitte)

Cl. 15-07 **134 183** 24.07.2007  
 1 design – machines et appareils de réfrigération et  
 congélation  
 Déposant: Société des Produits Nestlé SA, 1800 Vevey  
 Designer: Emmanuel Bourrousse, Beauvais  
 Mandataire: Nestec S.A., 1800 Vevey





FL 66592

Cl. 19-04 **134 184** 22.05.2007

1 Design – Verschluss für Tagungsmappe  
 Hinterleger: Norbert Buck, Friedrich-Schiller-Strasse 4,  
 88094 Oberteuringen, DE  
 Vertreter: Isler & Pedrazzini AG, 8027 Zürich  
 Priorität: EM, 22.11.2006

Beschreibung des Designs: Das Ordnersystem weist die Kombination einer Grifföffnung mit einem schlaufenförmigen Stifthalter auf. Eine bevorzugte Anordnung zeigt eine runde, durch einen Metallring eingefasste Öffnung, wie sie standardmässig im Rückenbereich von Ordnern verwendet wird, im vorderen Ordnerdeckel. Auf der Innenseite ist ein schlaufenförmiger Stifthalter angeordnet, dessen Schlaufe beim Schliessen des Ordners durch die Öffnung im Ordnerdeckel ragt. Der Ordner lässt sich dadurch mit einem Stift verschliessen. Diese Kombination aus Grifföffnung und Stifthalter bietet unterschiedliche Anwendungsmöglichkeiten als Verschluss für ein Ordnersystem.



M13378

Cl. 19-04 **134 185** 19.07.2007

4 Design – Ringbücher, Ordner  
 Hinterleger: Biella-Neher AG, Erlenstrasse 44,  
 2555 Brügg b. Biel  
 Designer: Roger Krebs, Schwadernau  
 Vertreter: Bovard AG, 3000 Bern 25

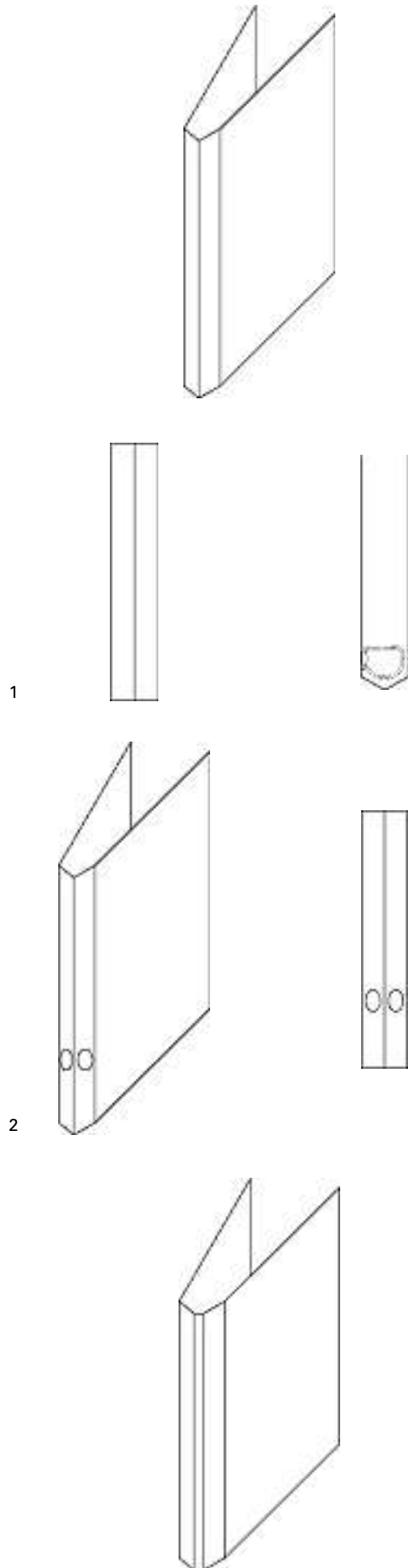

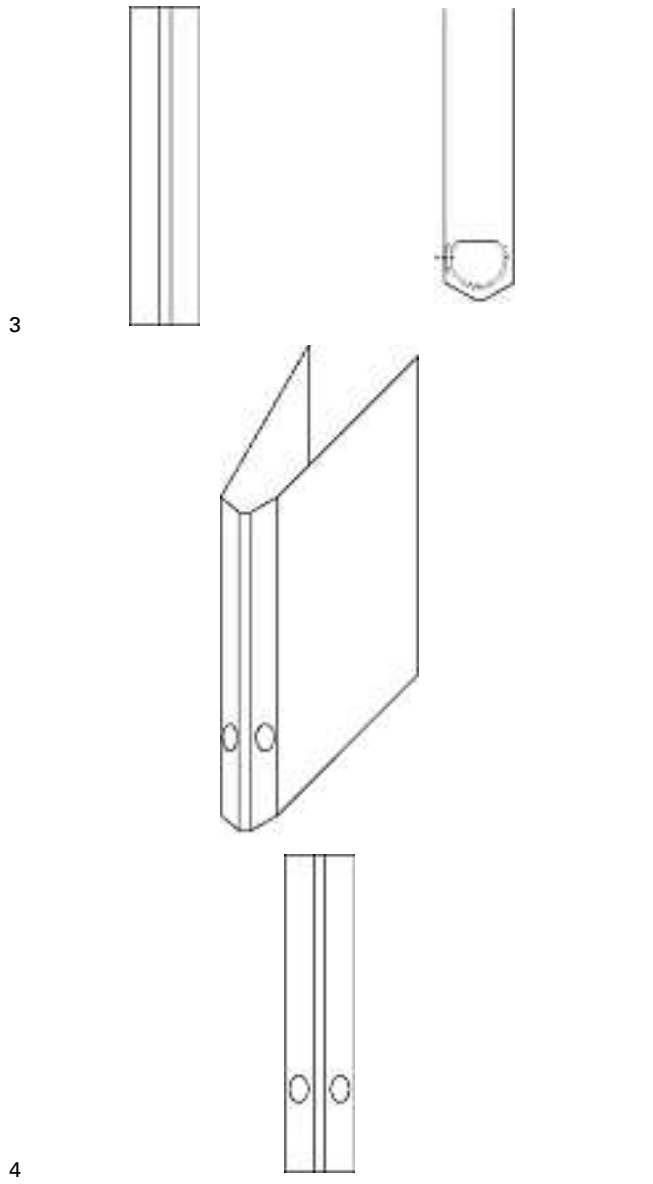

4  
 Cl. 19-06 134 186 23.07.2007  
 4 Design – Kugelschreiber  
 Hinterleger: Burger Pen AG, Postfach 48, 1713 St. Antoni  
 Designer: Harald Knauf, Karlsbad  
 Priorität: EM, 01.06.2007



3

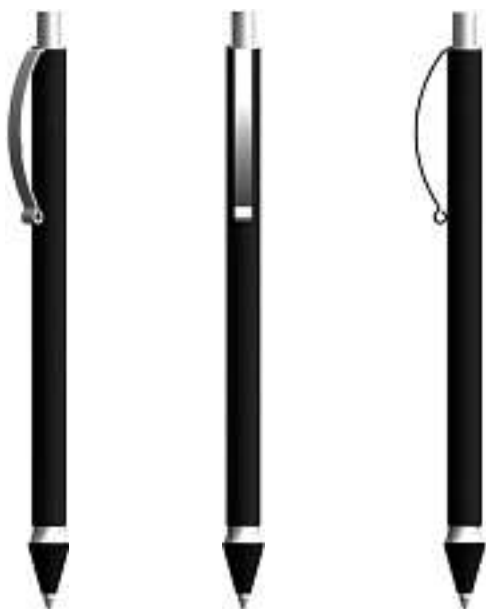

4

Cl. 19-08 134 187 08.08.2007

1 Design – Wandplaner

Hinterleger: Oacht16.CH Stephan Dachtler, Postfach 29, 5504 Othmarsingen

Designer: Stephan Dachtler, Othmarsingen

Beschreibung des Designs: Farbiger Wandplaner "DAS SCHWEIZER JAHR" jährlich neu. Veranstaltungen aus dem Bereich Sport, Kultur und Tradition aus der ganzen Schweiz werden nach Datum illustriert oder mit Logo erfasst.

DAS SCHWEIZER JAHR (siehe Farbteil Heftmitte)

Cl. 20-01 134 188 28.08.2007

1 Design – Verkaufsautomat

Hinterleger: Sielaff GmbH & Co. KG Automatenbau, Münchener Strasse 20, 91567 Herrieden, DE

Designer: Tom Visschers, Beek

Vertreter: Hepp Wenger Ryffel AG, 9500 Wil SG

Priorität: EM, 28.03.2007

MSIE002CH (siehe Farbteil Heftmitte)

Cl. 21-01 134 189 20.07.2007

1 design – jouet sexuel

Déposant: LRC Products Limited, 35 New Bridge Street, London EC4V 6BW, GB

Designer: Nicholas Charles Talbot, London; Ketan Mistry, London; Mark Vincent Critchley, Manchester; Calvin Lee Evans, Manchester

Mandataire: Kirker & Cie S.A., Ingénieurs-Conseils, 1226 Genève - Thônex

Priorité: EM, 31.01.2007

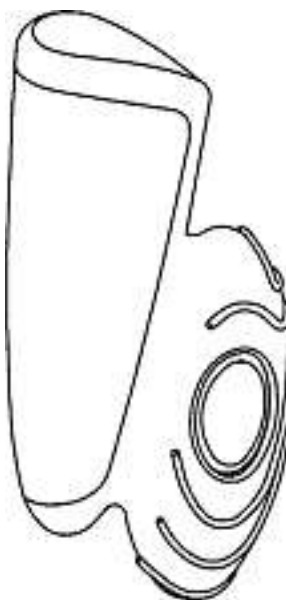
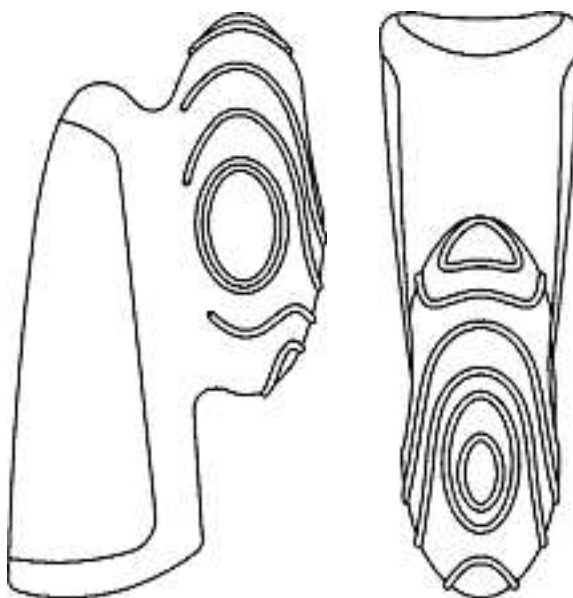
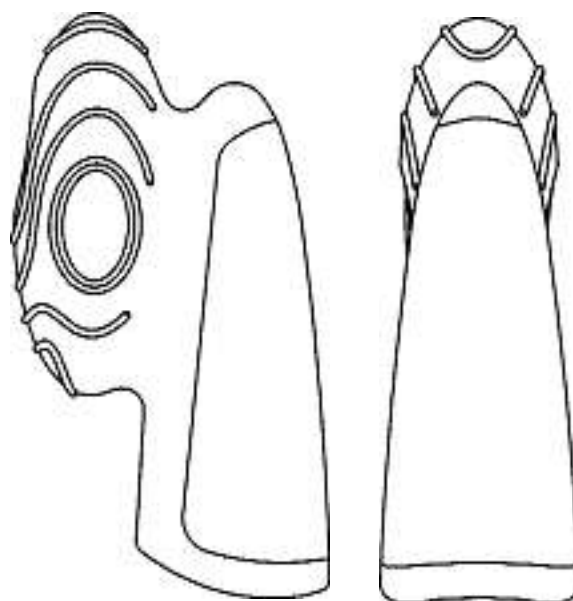

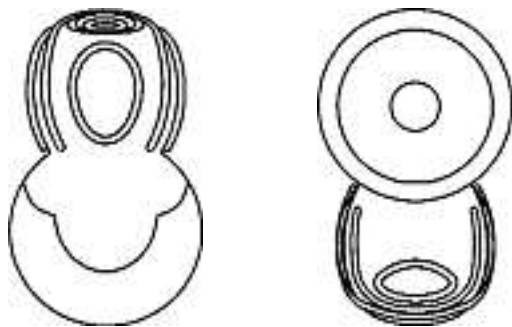

MPM/cl/310896-CH

Cl. 21-01 134 190 25.07.2007

19 Design – Spielzeug

Hinterleger: Wehrfritz GmbH, August-Grosch-Strasse 28-38,  
96476 Bad Rodach, DEDesigner: Eva Spanjardt, Meerbusch; Horst Dwinger,  
Weitramsdorf

Vertreter: Bovard AG, 3000 Bern 25

Priorität: DE, 12.02.2007

1.1 (siehe Farbteil Heftmitte)

2.1 (siehe Farbteil Heftmitte)

3.1 (siehe Farbteil Heftmitte)

4.1 (siehe Farbteil Heftmitte)

5.1 (siehe Farbteil Heftmitte)

6.1 (siehe Farbteil Heftmitte)

7.1 (siehe Farbteil Heftmitte)

8.1 (siehe Farbteil Heftmitte)

9.1 (siehe Farbteil Heftmitte)

10.1 (siehe Farbteil Heftmitte)

11.1 (siehe Farbteil Heftmitte)

12.1 (siehe Farbteil Heftmitte)

13.1 (siehe Farbteil Heftmitte)

14.1 (siehe Farbteil Heftmitte)

15.1 (siehe Farbteil Heftmitte)

16.1 (siehe Farbteil Heftmitte)

17.1 (siehe Farbteil Heftmitte)

18.1 (siehe Farbteil Heftmitte)

19.1 (siehe Farbteil Heftmitte)

Cl. 21-01 134 191 05.08.2007

1 Design – Spiel-Würfel

Hinterleger: Sohrab Kheradmandan, Bachstrasse 24,  
8902 Urdorf

Beschreibung des Designs: Das älteste Bilderrätsel der Welt wird in Form eines Würfels aus beidseitig anhaftenden geometrischen Magnetteilen (jede Seite 11 Dreiecks und 3 Fünfecks) mit verschiedenen Farben dargestellt. Das Besondere an diesem Spiel ist, dass sich die Anzahl der Möglichkeiten zur Lösung des Rätsels durch Verwendung von 12 verschiedenen Farben (z.B. silber, gold, purpurrot, hellblau, dunkelblau, hellgelb, dunkelgelb, weinrot, violett, lila, orange und braun) sowie durch die 3D-Form erhöht. Wegen verschiedenen Farbkombinationen kann dieses Spiel zusätzlich (aufgestellt auf einem Halter) als Dekorationsgegenstand z.B. in der Wohnung oder im Büro verwendet werden.

1 (siehe Farbteil Heftmitte)

Cl. 23-01 134 192 30.06.2007

1 Design – Trinkbrunnen

Hinterleger: Jürg Bracher, Birkenstrasse 16, 8962 Bergdietikon  
4055 (siehe Farbteil Heftmitte)

Cl. 23-02 134 193 09.07.2007

29 Design – Badaccessoires

Hinterleger: Erwin Müller GmbH, Breslauer Strasse 34-38,  
49808 Lingen (Ems), DE

Designer: Ulrich Finkeldey, Bielefeld; Kai Uetrech, Bielefeld

Vertreter: Schneider Feldmann AG, Patent- und

Markenanwälte, 8022 Zürich

Priorität: EM, 13.02.2007; EM, 05.03.2007

1



2



3





4



8



5



9



6



7



10





11



12



15



13



16



14



17



18



21



19



22



23



20



24



25



29



26



27

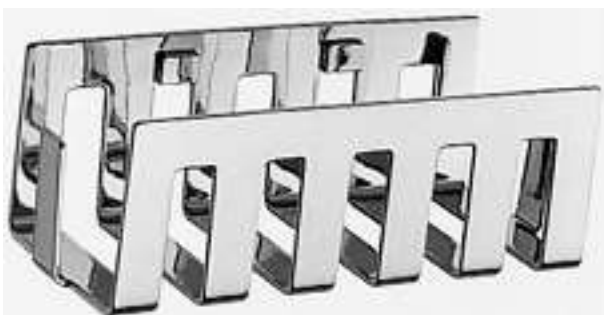

28

Cl. 24-02 **134 194** 20.08.2007

23 Design – medizinische Injektoren

Hinterleger: Sanofi-Aventis Deutschland GmbH,

Brüningstrasse 50, 65929 Frankfurt am Main, DE

Designer: Caroline Stephan, Offenbach; Michael Schabbach, Weinheim

Vertreter: Patentanwälte Schaad, Balass, Menzl &amp; Partner AG, 8034 Zürich

Priorität: EM, 23.02.2007

1 (siehe Farbteil Heftmitte)

2 (siehe Farbteil Heftmitte)

3 (siehe Farbteil Heftmitte)

4 (siehe Farbteil Heftmitte)

5 (siehe Farbteil Heftmitte)

6 (siehe Farbteil Heftmitte)

7 (siehe Farbteil Heftmitte)

8 (siehe Farbteil Heftmitte)

9 (siehe Farbteil Heftmitte)

10 (siehe Farbteil Heftmitte)

11 (siehe Farbteil Heftmitte)

12 (siehe Farbteil Heftmitte)

13 (siehe Farbteil Heftmitte)

14 (siehe Farbteil Heftmitte)

15 (siehe Farbteil Heftmitte)

16 (siehe Farbteil Heftmitte)

17 (siehe Farbteil Heftmitte)

18 (siehe Farbteil Heftmitte)

19 (siehe Farbteil Heftmitte)

20 (siehe Farbteil Heftmitte)

21 (siehe Farbteil Heftmitte)

22 (siehe Farbteil Heftmitte)

23 (siehe Farbteil Heftmitte)

Cl. 24-04 **134 195** 23.07.2007

1 Design – Hygiene-Produkt

Hinterleger: Intigena Produktions AG, Baarerstrasse 25, 6300 Zug

Designer: Herbert Sidler, Meggen; Heinz Scheidegger, Aeugst am Albis

Vertreter: OK pat AG, 6300 Zug

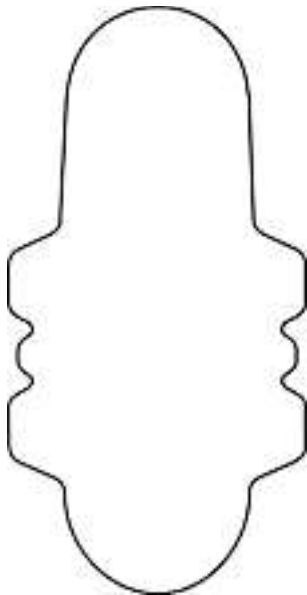

I06-0011D-CH

Cl. 24-04 134 196 21.08.2007  
 2 Design – Schuheinlagen  
 Hinterleger: Marcel Herzog, Schöneegg, 6402 Merlischachen  
 Vertreter: OK pat AG, 6300 Zug  
 O05-0002D/1 (siehe Farbteil Heftmitte)  
 O05-0002D/2 (siehe Farbteil Heftmitte)

Cl. 25-02 134 197 16.07.2007  
 1 Design – Raumteiler  
 Hinterleger: Peter Pfeiffer, Angerstrasse 16,  
 79618 Rheinfelden, DE  
 Vertreter: Patentanwalt Matthias W. Schäfer, 8001 Zürich



5606667

Cl. 25-03 134 198 02.07.2007  
 3 Design – Gebäude  
 Hinterleger: CosmoHelvetia AG, Rue du Valentin 34,  
 1004 Lausanne  
 Designer: Stefanie Berchtenbreiter-Overbeck, Schmitt

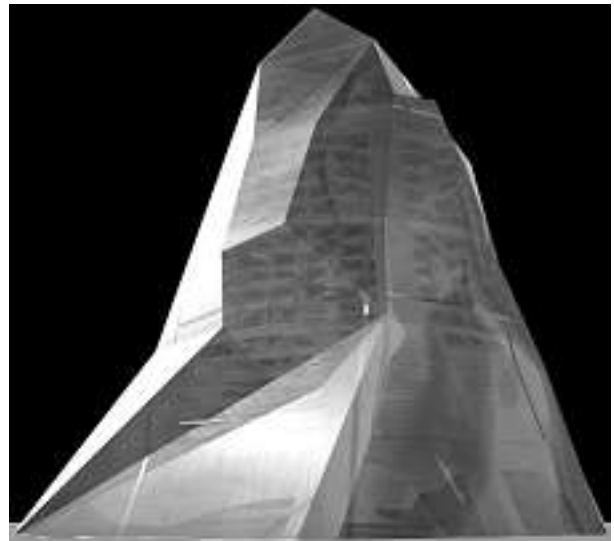

E\_07 Dubai-1

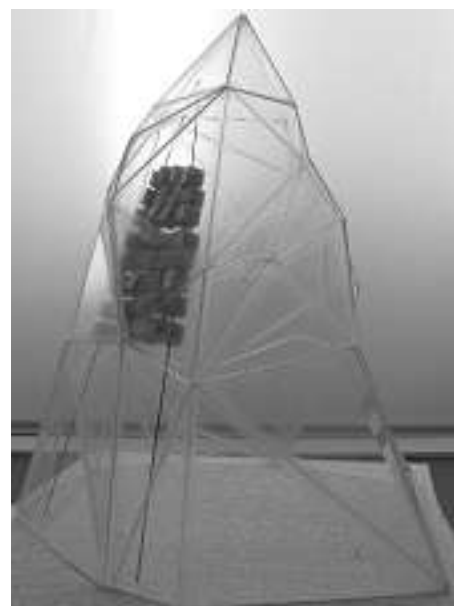

E\_07 Dubai-2

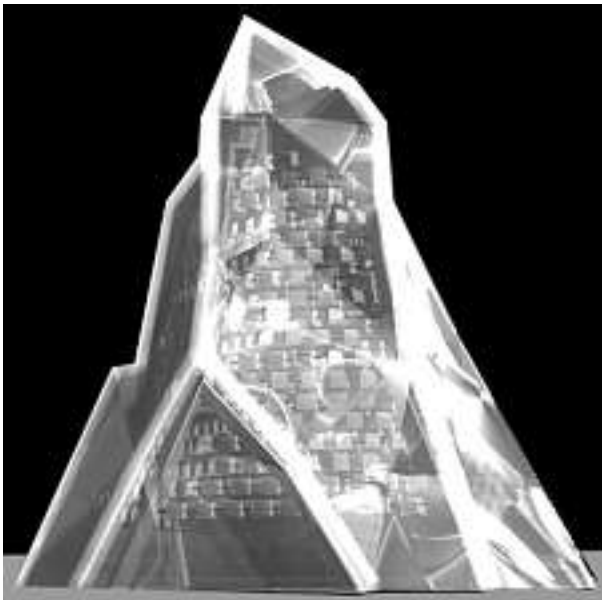
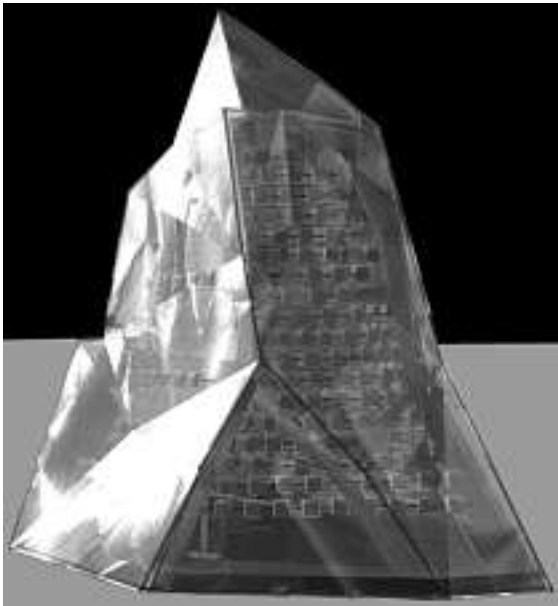

E\_07 Dubai-3

**Verlängerungen  
Prolongations  
Prolongazioni**

116 195	Cl.	20-03	1 Design
116 226	Cl.	09-05	1 Design
116 299	Cl.	10-02	1 Design

119 930	Cl.	06-03	1 Design
---------	-----	-------	----------



909

119 984 Cl. 06-07 1 Design



120 031 Cl. 15-02 1 Design





1

124 443	Cl.	28-03	1 Design
124 464	Cl.	14-01	1 Design
124 471	Cl.	21-01	28 Design
124 473	Cl.	23-02	1 Design
124 482	Cl.	28-03	5 Design
124 614	Cl.	24-01	1 Design
124 657	Cl.	21-01	1 Design
124 726	Cl.	26-05	1 Design
128 603	Cl.	05-05	34 Design
128 994	Cl.	06-01	8 Design
129 033	Cl.	12-15	1 Design
129 058	Cl.	24-04	1 Design
129 128	Cl.	05-05	3 Design
129 131	Cl.	06-03	1 Design
129 198	Cl.	09-03	11 Design
129 216	Cl.	05-05	1 Design
129 276	Cl.	02-07	1 Design
129 333	Cl.	19-06	1 design
129 380	Cl.	06-01	1 Design
129 405	Cl.	25-01	1 Design

## Mutationen Modifications Modificazioni

123 809

Übertragung

Hinterleger: Thurgau Tourismus, Egelmoosstrasse 1,  
8580 Amriswil

**Löschungen**  
**Radiations**  
**Radiazioni**

119 491	Cl.	15-05	1 design
119 517	Cl.	13-02	1 Design
119 523	Cl.	21-01	2 Design
119 606	Cl.	09-01	2 Design
123 901	Cl.	09-03	1 Design
123 905	Cl.	10-07	2 Design
123 920	Cl.	23-02	4 design
123 926	Cl.	02-04	17 Design
123 933	Cl.	08-08	1 Design
123 942	Cl.	18-02	11 Design
123 949	Cl.	25-01	2 Design
123 985	Cl.	19-04	4 design
124 004	Cl.	04-02	14 Design
128 544	Cl.	10-04	1 design
128 551	Cl.	14-03	36 Design
128 562	Cl.	02-01	3 Design
128 564	Cl.	03-01	1 Design
128 568	Cl.	06-01	5 Design
128 569	Cl.	06-01	1 Design
128 570	Cl.	06-01	3 Design
128 573	Cl.	06-03	120 Design
128 575	Cl.	06-04	3 Design
128 577	Cl.	06-09	1 Design
128 578	Cl.	06-11	5 Design
128 579	Cl.	07-01	3 Design
128 580	Cl.	07-01	1 Design
128 584	Cl.	09-03	13 Design
128 586	Cl.	09-03	3 Design
128 590	Cl.	10-02	2 design
128 597	Cl.	99-00	1 Design
128 599	Cl.	02-02	14 Design
128 619	Cl.	09-01	1 Design

**Berichtigungen**  
**Rectifications**  
**Rettifiche**

**134 088**  
 Rettifica del designer  
 Daisuke Sawai, Saitama-ken



Cl. 05-06

134 151

18.07.2007



15054A

Cl. 06-04

134 157

20.07.2007



Rollin-RollOut

Cl. 07-01

134 160

17.08.2007

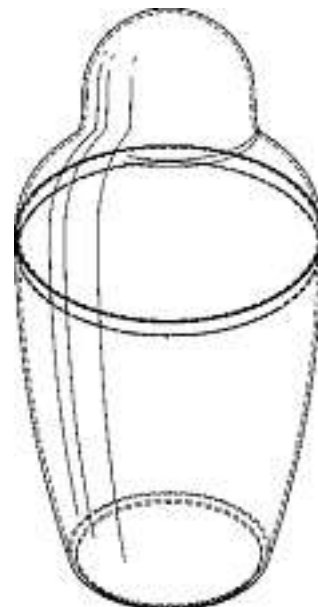
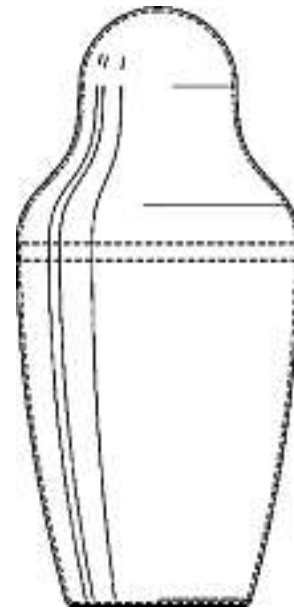

1



2

3



4



5



Farbteil 2

6

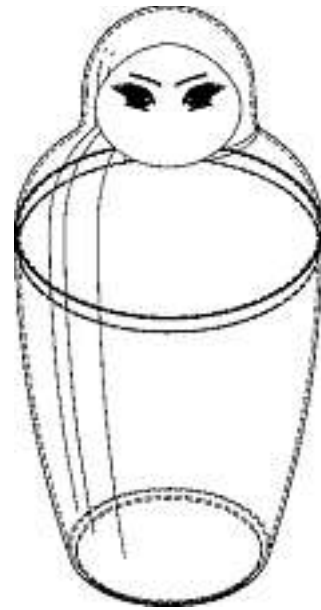

6

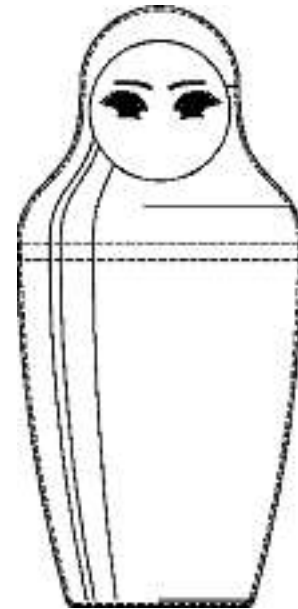

7





8



Cl. 07-02

134 162

17.08.2007



1





2





3

Cl. 07-05

134 164

09.08.2007



1



2

Cl. 08-03

134 168

12.07.2007



1



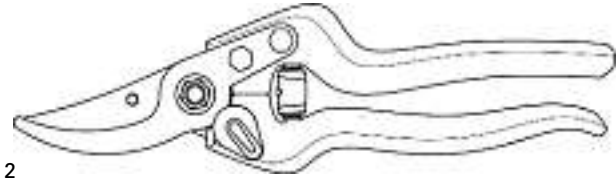

2



3

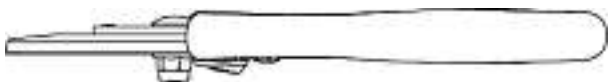

4

Cl. 12-11

134 179

11.07.2007



C11CHMO-1.1



C11CHMO-2.1



C11CHMO-3.1



C11CHMO-4.1

Cl. 12-16

134 180

26.07.2007



Sunshade

Cl. 13-03

134 182

19.07.2007



1

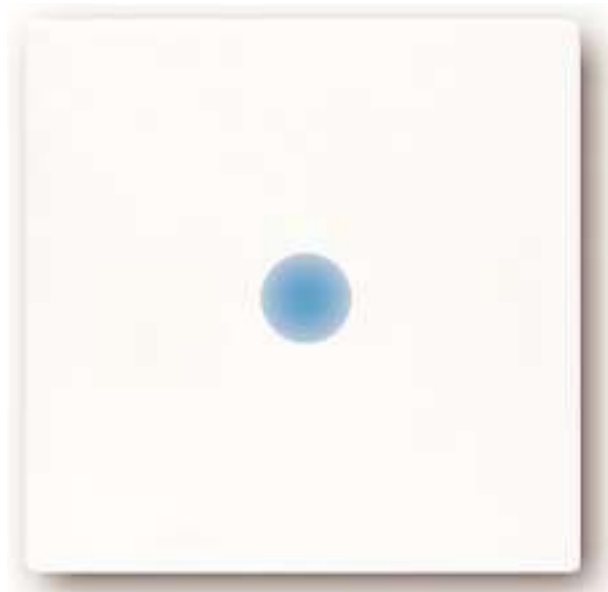

2

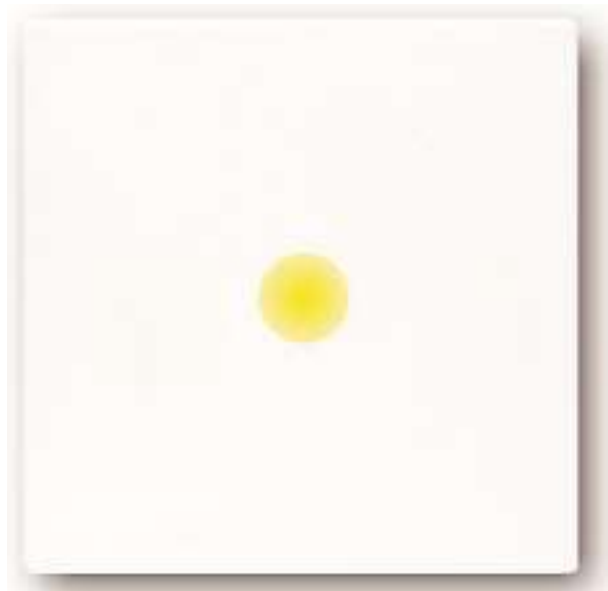

3



4



5



6

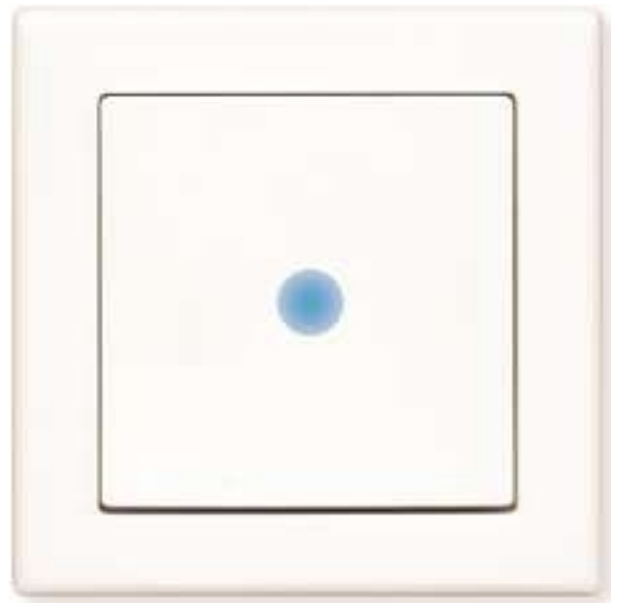

9



7

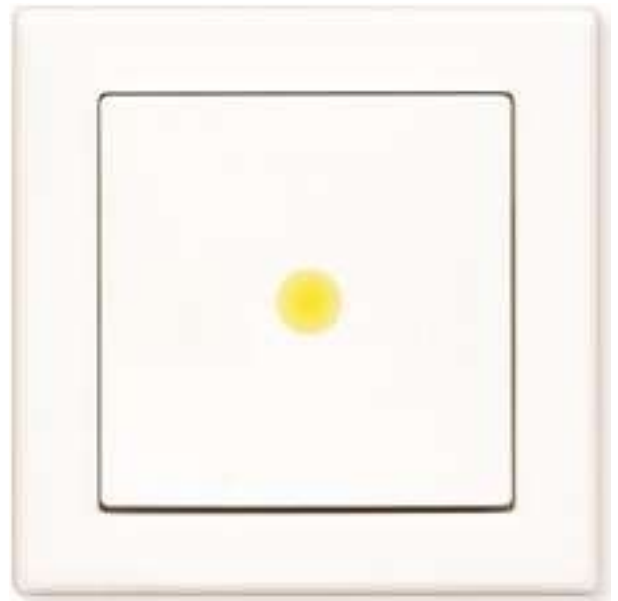

10

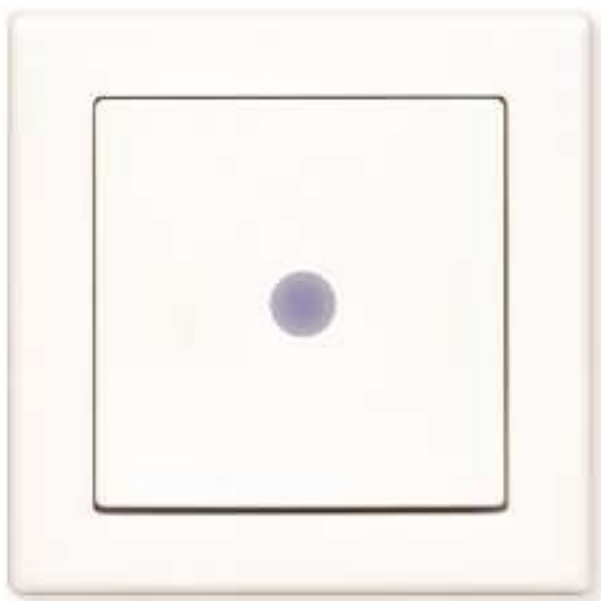

8

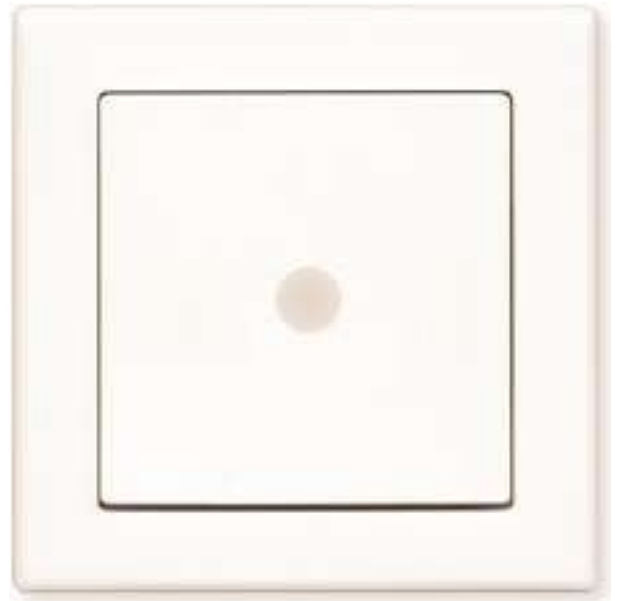

11



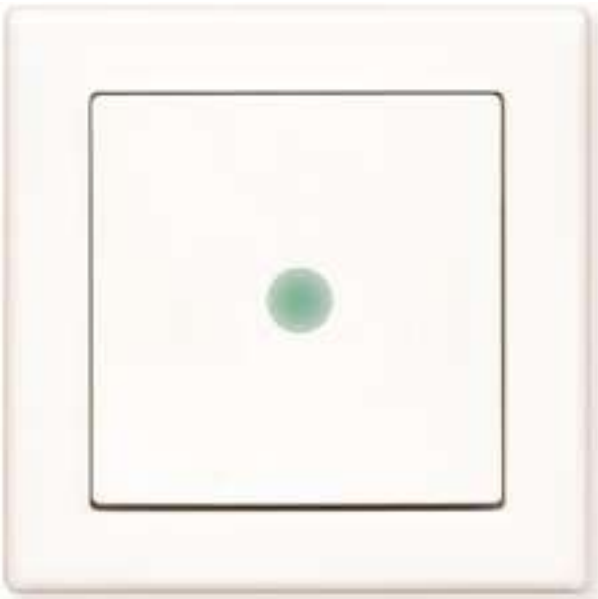

12



15

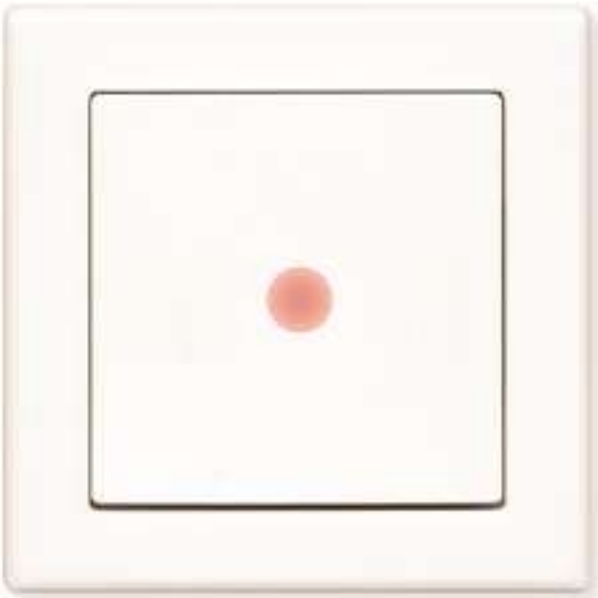

13

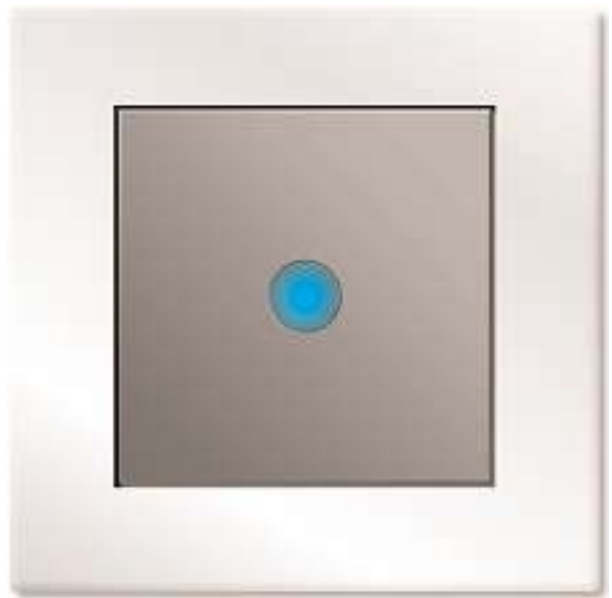

16

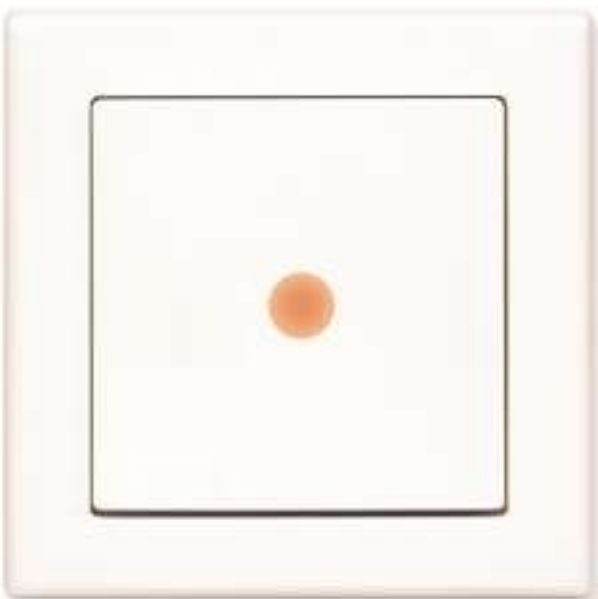

14

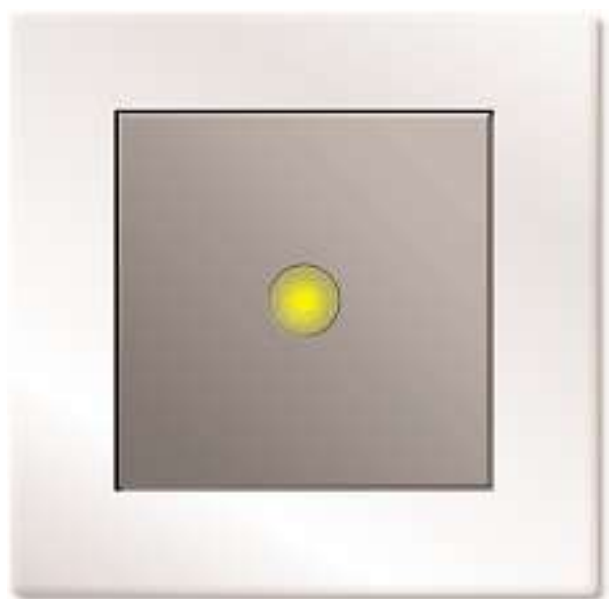

17



18

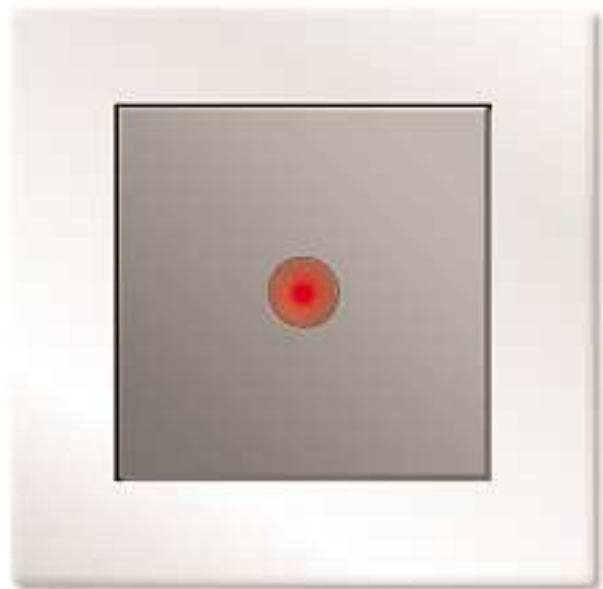

21

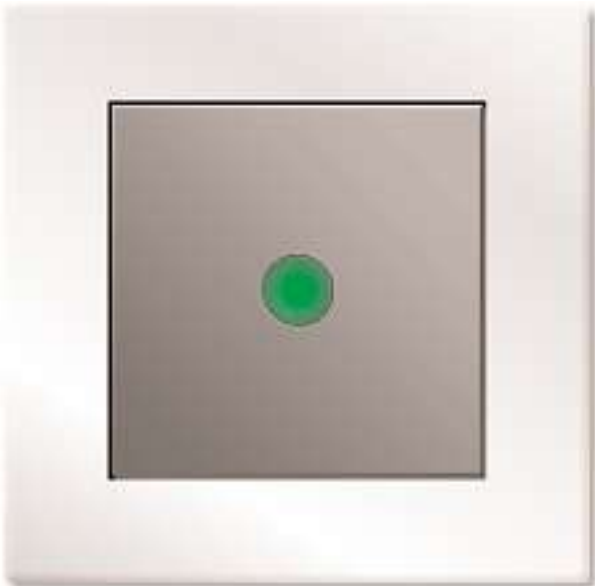

19



22



20

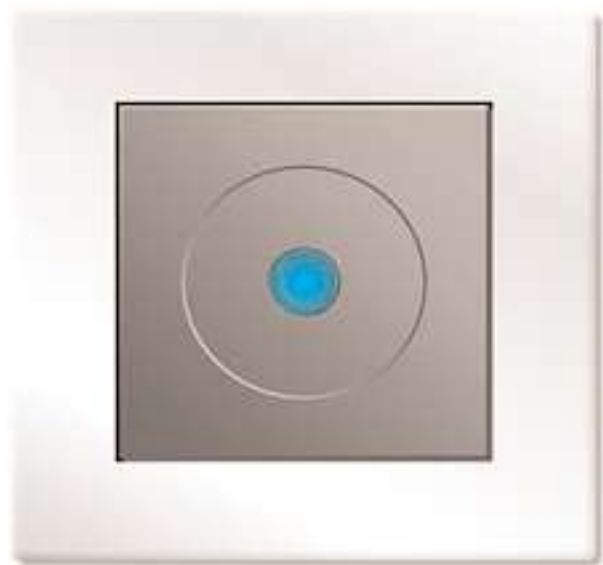

23

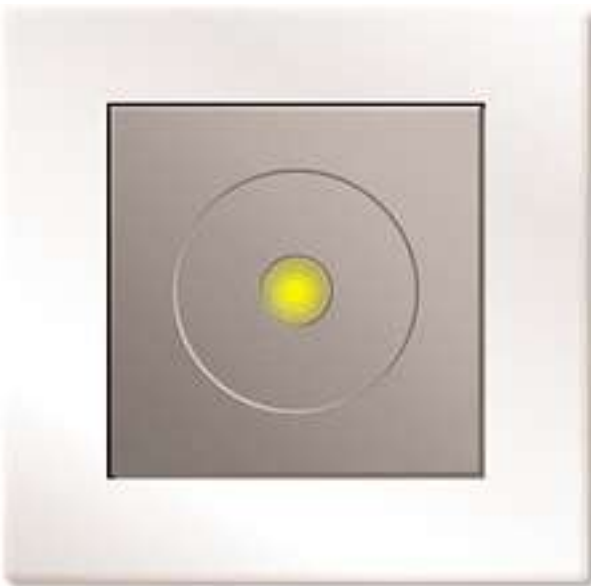

24

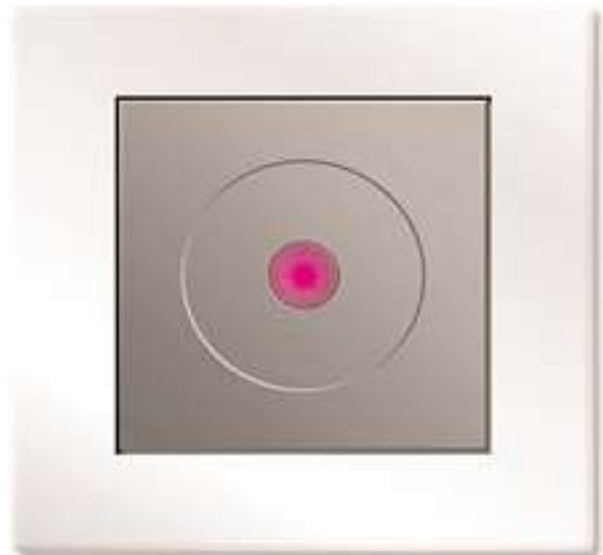

27

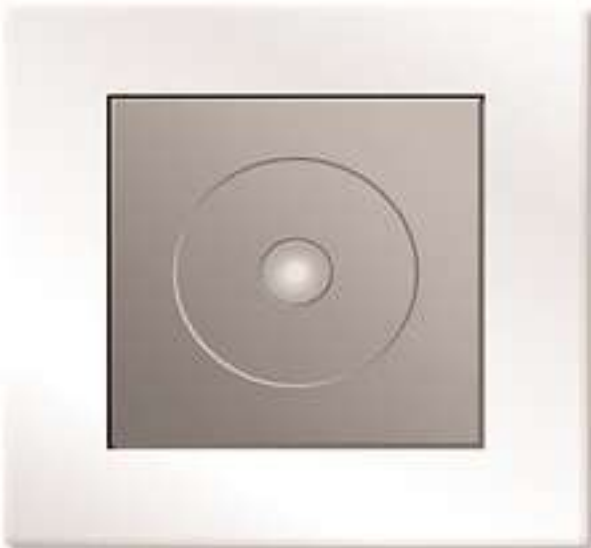

25

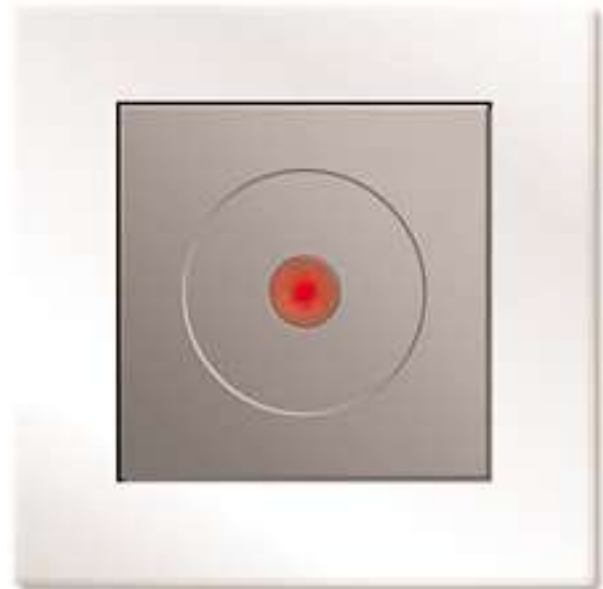

28



26

Cl. 19-08

134 187

08.08.2007



DAS SCHWEIZER JAHR

Cl. 20-01

134 188

28.08.2007





MSIE002CH

Cl. 21-01

134 190

25.07.2007



3.1

16.1



1.1



4.1



2.1



5.1



6.1



9.1



7.1



10.1



8.1



11.1



12.1



15.1



13.1



17.1



14.1



18.1



19.1

Cl. 21-01 134 191 05.08.2007



1

Cl. 23-01 134 192 30.06.2007



4055

Cl. 24-02 134 194 20.08.2007







1



4



2



5



3





6



7



8



9



10





11



12



13



14



15





16



17



18



19



20





21



22

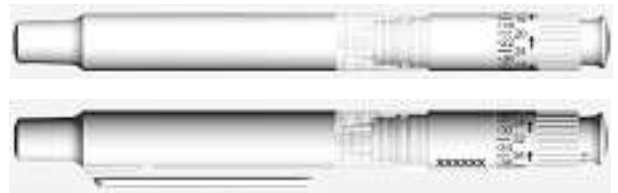

23

Cl. 24-04

134 196

21.08.2007



O05-0002D/1



O05-0002D/2