

Nationale Hinterlegungen

In der folgenden Liste werden die beim Eidgenössischen Institut für Geistiges Eigentum hinterlegten Designs publiziert. Dabei sind der Reihe nach angegeben:

- internationale Klassenangaben
- Hinterlegungsnummer
- Hinterlegungsdatum
- Allenfalls Aufschub der Veröffentlichung
- Anzahl der hinterlegten Designs
- Bezeichnung
- Name und Wohnsitz des Hinterlegers oder der Hinterlegerin
- gegebenenfalls Name und Wohnsitz des Designers oder der Designerin
- Name und Geschäftssitz des allfälligen Vertreters oder der Vertreterin
- gegebenenfalls Prioritätsangaben
- gegebenenfalls Beschreibungstext
- Ordnungsnummer
- Reproduktion des Designs

Internationale Hinterlegungen

Die bei der Weltorganisation für geistiges Eigentum in Genf hinterlegten Muster und Modelle mit Benennung Schweiz geniessen den gleichen Schutz wie national hinterlegte Designs. Sie werden jeweils im Blatt «Bulletin des dessins et modèles internationaux» veröffentlicht. Dieses Publikationsorgan ist deshalb für eine vollständige Recherche unbedingt beizuziehen.

Topographien

Angaben über die vom Eidgenössischen Institut für Geistiges Eigentum eingetragenen Topographien von Halbleitererzeugnissen werden in folgender Anordnung aufgeführt:

- Eintragsnummer
- Anmeldedatum
- Bezeichnung
- Name und Wohnsitz des Anmelders oder der Anmelderin
- gegebenenfalls Name und Wohnsitz des Herstellers oder der Herstellerin
- Name und Geschäftssitz des oder der allfälligen Bevollmächtigten
- Datum und Ort einer allfälligen ersten geschäftlichen Verbreitung der Topographie

Dépôts nationaux

Les designs déposés à l'Institut Fédéral de la Propriété Intellectuelle sont publiés dans la liste qui suit. Les indications y relatives sont mentionnées dans cet ordre:

- indications des classes internationales
- numéro de dépôt
- date de dépôt
- le cas échéant, ajournement de la publication
- nombre des designs déposés
- désignation
- nom et domicile du/de la déposant/e
- le cas échéant, nom et domicile du/de la designer
- nom et domicile de l'éventuel/le mandataire
- le cas échéant, indication de priorité
- le cas échéant, description du design
- numéro attribué à chaque design
- reproduction du design

Dépôts internationaux

Les dessins et modèles déposés à l'Organisation Mondiale de la Propriété Intellectuelle à Genève qui désignent la Suisse jouissent de la même protection que les dépôts nationaux. Ils sont chaque fois publiés dans la feuille «Bulletin des dessins et modèles internationaux». Pour une recherche complète, il est indispensable de consulter ledit organe de publication.

Topographies

Les indications concernant les topographies des produits semi-conducteurs, enregistrées par l'Institut Fédéral de la Propriété Intellectuelle, sont énumérées dans l'ordre suivant:

- numéro d'enregistrement
- date de dépôt
- désignation
- nom et domicile du/de la déposant/e
- le cas échéant, nom et domicile du/de la producteur/trice
- nom et domicile de l'éventuel/le mandataire
- date et lieu d'une éventuelle première mise en circulation de la topographie

Depositi nazionali

Nella lista seguente vengono pubblicati i design depositati presso l'Istituto Federale della Proprietà Intellettuale. Sono menzionati nel seguente ordine:

- indicazioni delle classi internazionali
- numero di deposito
- data del deposito
- se del caso, indicazione che la pubblicazione è stata differita
- numero dei design depositati
- designazione
- nome e domicilio del depositante
- se del caso, nome e domicilio del designer
- nome e sede di un eventuale mandataro
- se del caso, indicazioni di priorità
- se del caso, descrizione del design
- numero d'ordine
- riproduzione del design

Depositi internazionali

I disegni e modelli depositati presso l'Organizzazione Mondiale della Proprietà Intellettuale a Ginevra con denominazione Svizzera godono della medesima protezione del deposito nazionale. Essi vengono pubblicati ogni volta nel foglio «Bulletin des dessins et modèles internationaux». Quest'organo di pubblicazione è da consultare se si vuole effettuare una ricerca completa.

Topografie

Le indicazioni concernenti le topografie di prodotti a semiconduttori depositati presso l'Istituto Federale della Proprietà Intellettuale sono menzionate nell'ordine seguente:

- numero di registrazione
- data del deposito
- designazione
- nome e domicilio del/la richiedente
- se del caso, nome e domicilio del/la produttore/trice
- nome e sede di un eventuale mandataro
- data e luogo di un'eventuale prima messa in circolazione della topografia

Hinterlegungen
Dépôts
Deposit

Cl. 30-02 131 354 08.01.2005
 10 design – mobiliers pour animaux
 Déposant: Isabelle Graf, 11 rue des Gares, 1201 Genève,
 France Vésy, 19 place Montbrillant, 1201 Genève
 Mandataire: Isabelle Graf, 1201 Genève
 Fin de la période ajournement de la publication



xx10



xx11



xx12



xx13



xx14



xx15



xx16



xx17



xx18



xx19

Cl. 20-02 131 735 02.02.2005
 1 Design – Steller
 Hinterleger: Bruno Messerli, Hauptstrasse 106, Brittern,
 4587 Aetingen
 Ende aufgeschobene Publikation



Bodensteller

Cl. 02-04 133 885 30.04.2007
 6 design – chaussures, semelles
 Déposant: JM WESTON, Rue Nicolas Appert, Zone
 Industrielle Nord, Limoges, FR
 Designer: Jean-Christopher Descours, Limoges
 Mandataire: Griffes Consulting S.A., 1206 Genève



0111-MO-0066-CH





0111-MO-0067-CH



0111-MO-0068-CH



0111-MO-0069-CH



0111-MO-0070-CH



0111-MO-0071-CH



Cl. 06-01 133 886 11.04.2007
1 Design – Sessel
Hinterleger: GLAESER Möbelbau AG, Im Grund 16,
5405 Baden-Dättwil
Designer: Willi Glaeser, Baden; Jörg Boner, Zürich



Wogg 42 - Sessel

Cl. 06-01 133 887 12.04.2007
 2 Design – Stühle
 Hinterleger: Brunner GmbH, Im Salmenkopf 10,
 77866 Rheinau-Freistett, DE

Designer: Wolfgang C.R. Mezger, Eisingen
 Vertreter: PA Aldo Römler, 9410 Heiden
 Priorität: DE, 24.10.2006; DE, 09.11.2006



1



2



Cl. 06-01 **133 888** 12.04.2007
 2 Design – Stühle
 Hinterleger: Brunner GmbH, Im Salmenkopf 10,
 77866 Rheinau-Freistett, DE
 Designer: Wolfgang C.R. Mezger, Eislingen
 Vertreter: PA Aldo Römpler, 9410 Heiden
 Priorität: DE, 24.10.2006; DE, 09.11.2006







2

1

Cl. 06-01 133 889 12.04.2007
3 Design – Sitzmöbel
Hinterleger: Brunner GmbH, Im Salmenkopf 10,
77866 Rheinau-Freistett, DE
Designer: Wolfgang C.R. Mezger, Eislingen
Vertreter: PA Aldo Römpler, 9410 Heiden
Priorität: DE, 24.10.2006; DE, 09.11.2006



2

3

Cl. 06-01 133 890 12.04.2007
7 Design – Stühle
Hinterleger: Brunner GmbH, Im Salmenkopf 10,
77866 Rheinau-Freistett, DE
Designer: Wolfgang C.R. Mezger, Eislingen
Vertreter: PA Aldo Römpler, 9410 Heiden
Priorität: DE, 24.10.2006; DE, 10.11.2006



1



2



3



4





6



5



7



Cl. 06-01 **133 891** 12.04.2007
 7 Design – Stühle
 Hinterleger: Brunner GmbH, Im Salmenkopf 10,
 77866 Rheinau-Freistett, DE
 Designer: Christian Lepper, Kassel; Roland Schmidt, Kassel;
 Uwe Sommerlade, Kassel
 Vertreter: PA Aldo Römpler, 9410 Heiden
 Priorität: DE, 24.10.2006; DE, 10.11.2006





1



2





4



3







7

Cl. 06-01 **133 892** 13.04.2007
 1 Design – Sofa
 Hinterleger: Vitra Patente AG, Klünenfeldstrasse 22,
 4132 Muttenz
 Designer: Hella Jongerius, Rotterdam
 Vertreter: AXON Patent GmbH, 4147 Aesch





1

Cl. 06-01 133 893 17.04.2007

1 Design – Sitz

Hinterleger: Thomas Frutschi, Roman-Burri-Strasse 1, 6210 Sursee

Beschreibung des Designs: Axialsymmetrisch geschwungene Sitzschale (ca. 60x30x14 cm) in Kunststoff o.ä. Für Sitzhöhen ca. 45-78 cm. x-Achse hochgezogen als Stützgriffe resp. Taschenhaken; y-Achse rund tiefgezogen.

Besonders geeignet für den öffentlichen (Aussen-)Raum.



TAF 01

Cl. 06-03 133 894 11.04.2007

1 Design – Tisch

Hinterleger: GLAESER Möbelbau AG, Im Grund 16, 5405 Baden-Dättwil

Designer: Willi Glaeser, Baden; Jörg Boner, Zürich



Wogg 43 - Tisch

Cl. 06-03 133 895 12.04.2007

2 Design – Tische

Hinterleger: Brunner GmbH, Im Salmenkopf 10, 77866 Rheinau-Freistett, DE

Designer: Christian Lepper, Kassel; Roland Schmidt, Kassel; Uwe Sommerlade, Kassel

Vertreter: PA Aldo Römpler, 9410 Heiden

Priorität: DE, 24.10.2006; DE, 10.11.2006

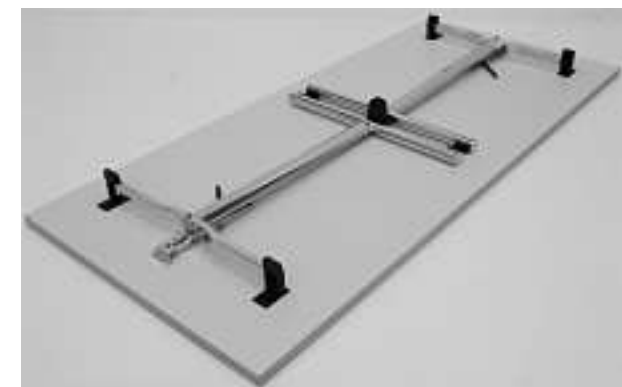



1

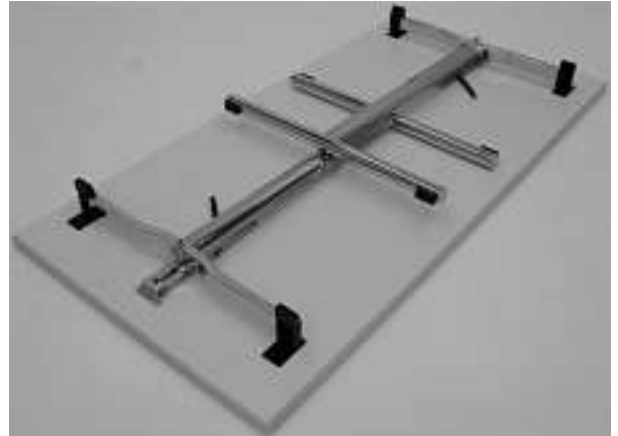

2

Cl. 06-03 133 896 13.04.2007

3 Design – Tische

Hinterleger: Vitra Patente AG, Klünenfeldstrasse 22, 4132 Muttenz

Designer: Hella Jongerius, Rotterdam

Vertreter: AXON Patent GmbH, 4147 Aesch



1

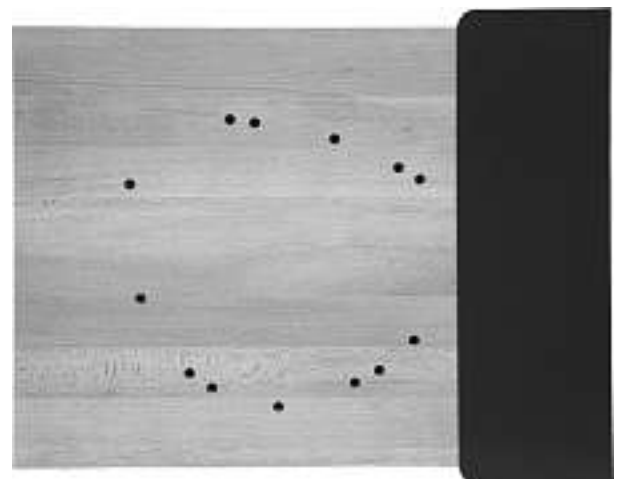

2

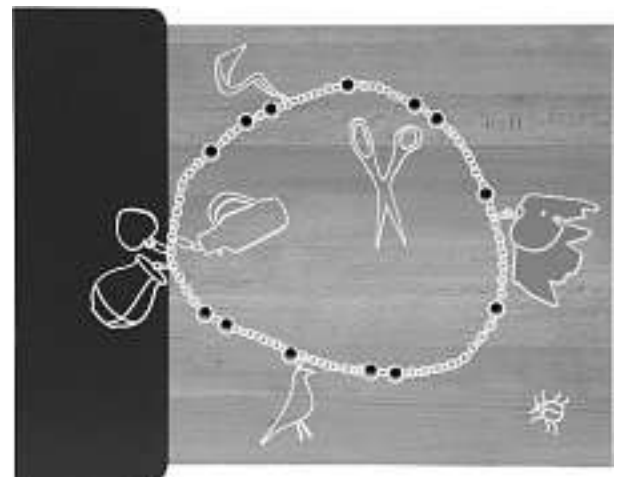

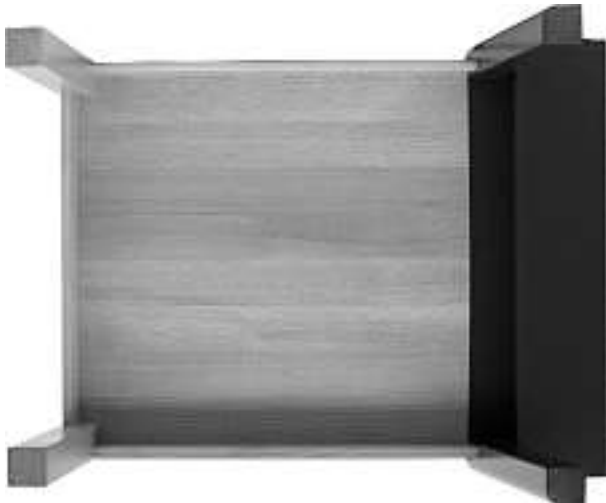

3

Cl. 07-01 **133 897** 23.04.2007
 1 Design – Teekrug
 Hinterleger: PI-DESIGN AG, Kantonsstrasse 100,
 6234 Triengen
 Designer: Jorgen Bodum, St. Niklausen
 Vertreter: Isler & Pedrazzini AG, 8027 Zürich
 Priorität: DK, 31.10.2006







M13323

Cl. 08-08 133 898 17.04.2007

1 design – dispositif économiseur de carburant
 Déposant: Miguel Castillo Garcia, 4, quai Ernest-Ansermet,
 1205 Genève

Description du design: Ce dispositif est constitué de deux éléments identiques comportant chacun un aimant et des moyens pour les lier entre eux. Il est destiné à entourer un tuyau d'alimentation, de manière à ce que le carburant traverse un champ magnétique.



1

Cl. 09-02 133 899 23.04.2007

4 design – récipients pour liquides

Déposant: Shell Brands International AG, Baarermatte,
 6340 Baar

Designer: Guy Anthony Williams, Londres; Timothy Peter
 James, Londres

Mandataire: Kirker & Cie S.A., Ingénieurs-Conseils,
 1226 Genève - Thônex

Priorité: GB, 13.12.2006; GB, 12.01.2007

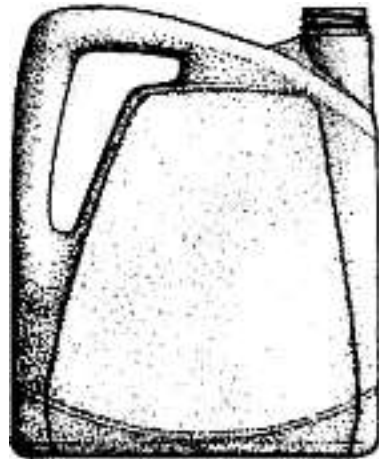
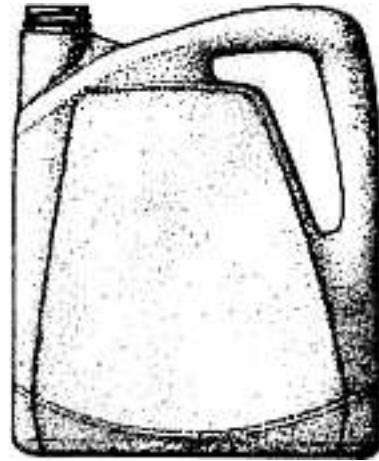

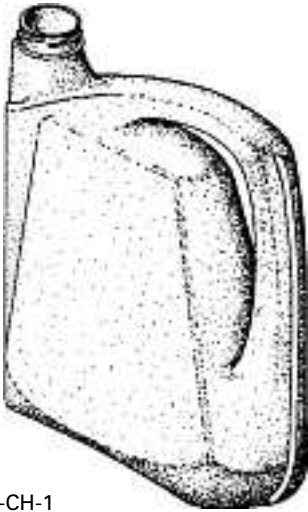
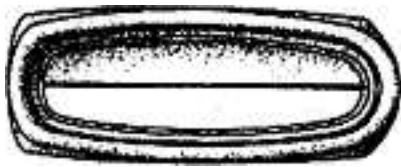

MPM/cl/310692-CH-1

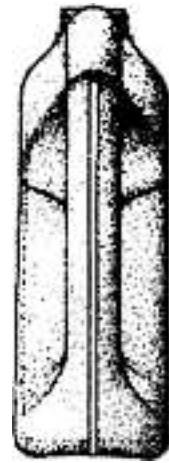
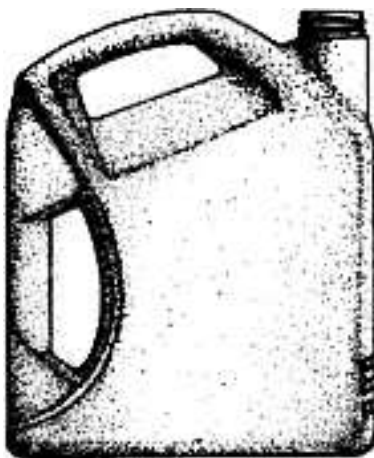
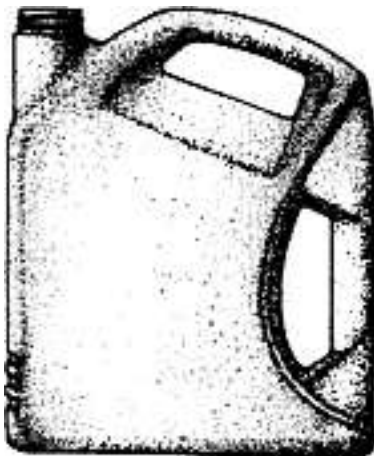

MPM/cl/310692-CH-2

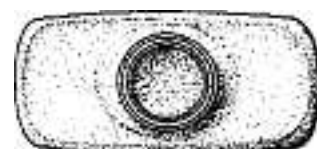
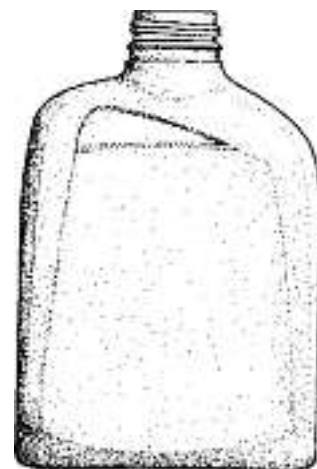
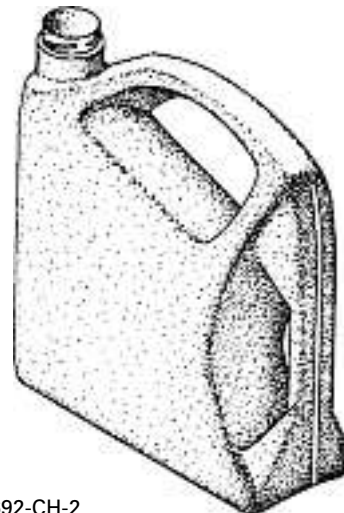

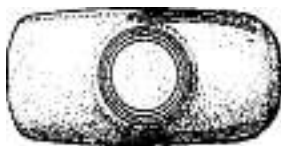
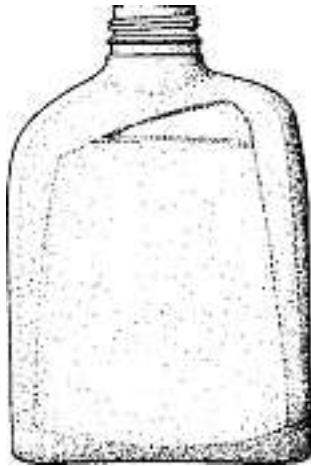
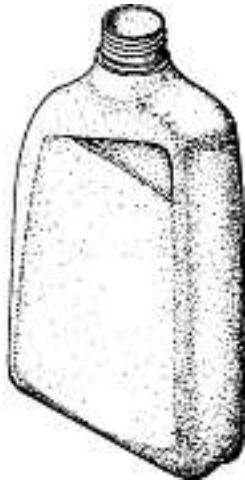
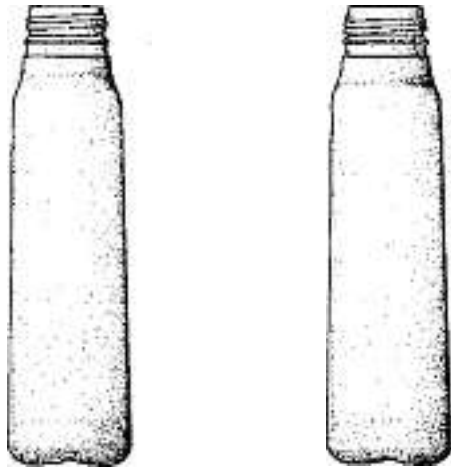

MPM/cl/310692-CH-3

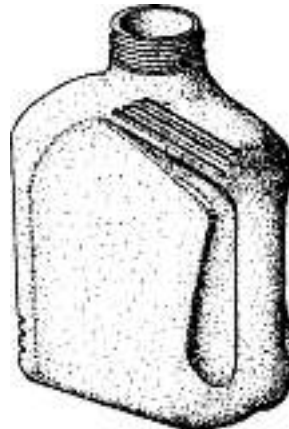
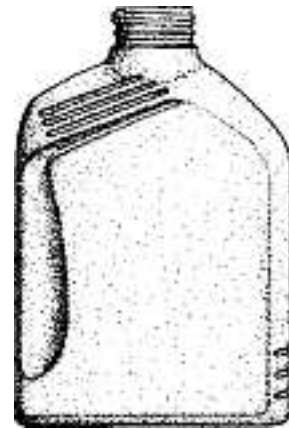
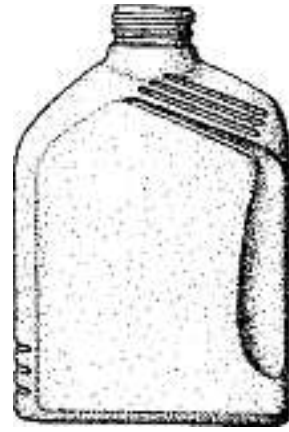

MPM/cl/310692-CH-4

Cl. 09-03 133 900 21.03.2007
2 Design – Verpackung
Hinterleger: Mars, Incorporated, A Delaware Corporation,
6885 Elm Street, McLean/VA, US
Designer: Mark Scholefield, Batley
Vertreter: A.W. Metz & Co. AG, 8024 Zürich
Priorität: EM, 17.01.2007

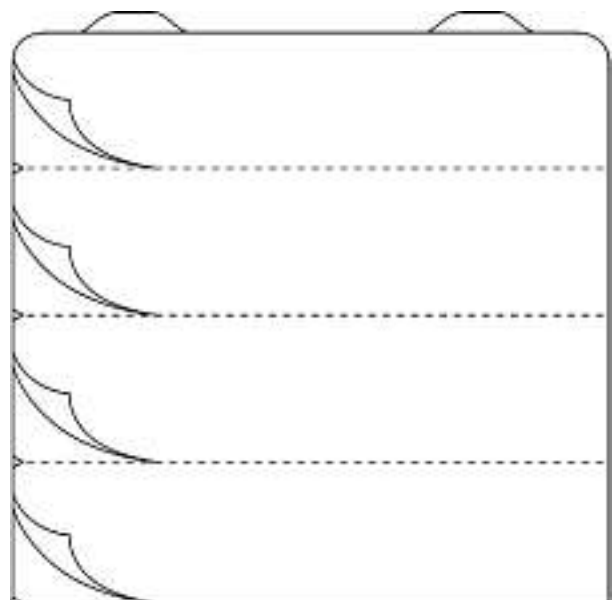
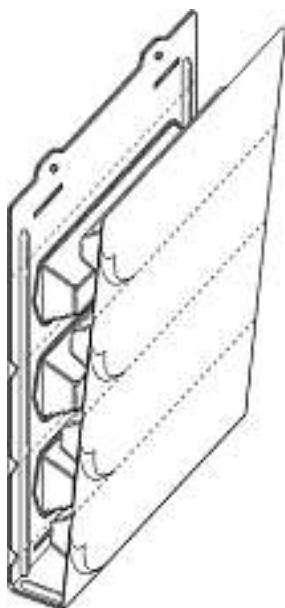
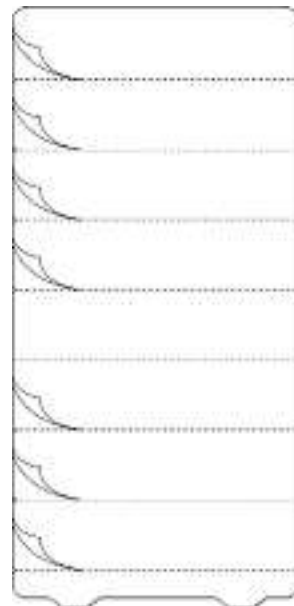
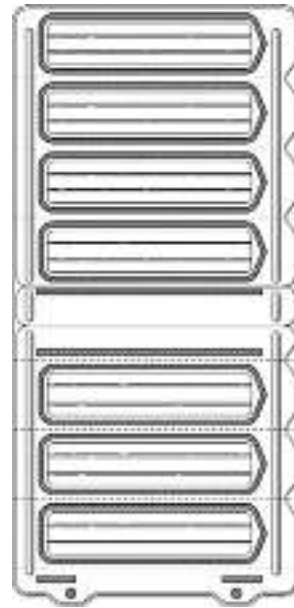
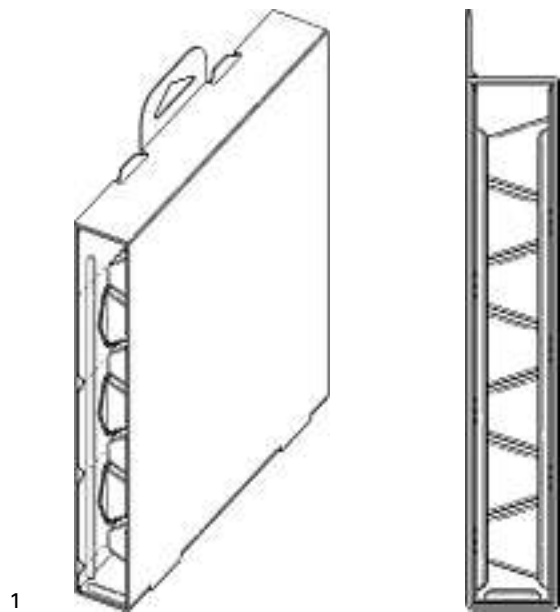

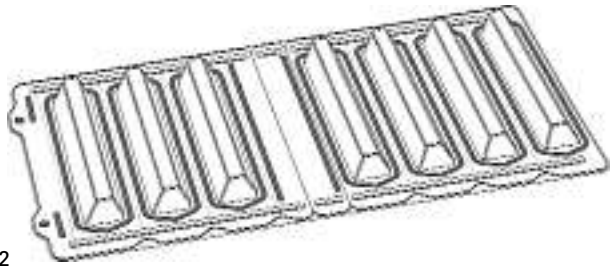

2

Cl. 09-07 **133 901** 17.04.2007
 1 Design – Aktuator
 Hinterleger: GlaxoSmithKline Consumer Healthcare GmbH &
 Co. KG, Bussmatten 1, Bühl, DE
 Designer: Christoph Geiberger, Königswinter
 Vertreter: Isler & Pedrazzini AG, 8027 Zürich
 Priorität: GB, 20.10.2006

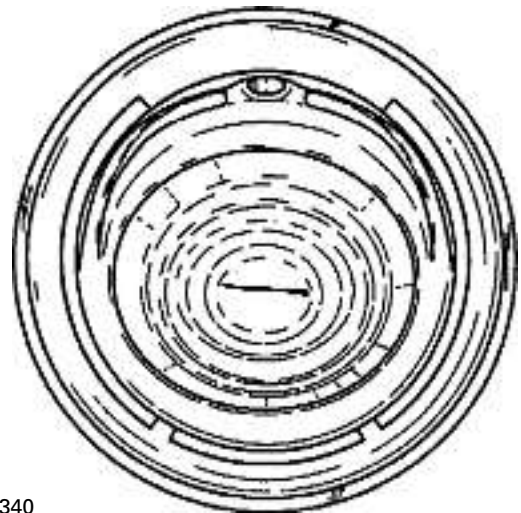
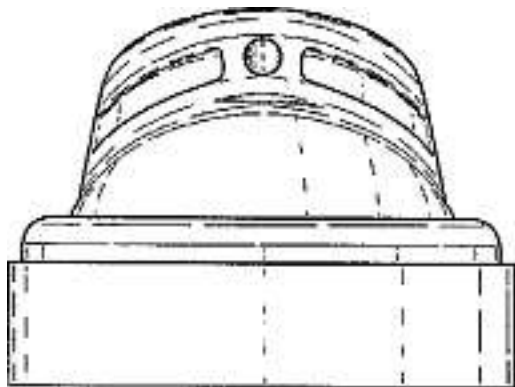
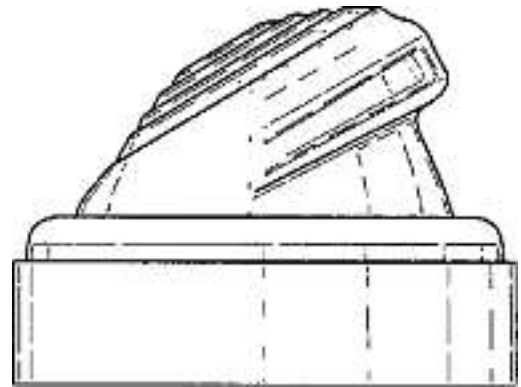
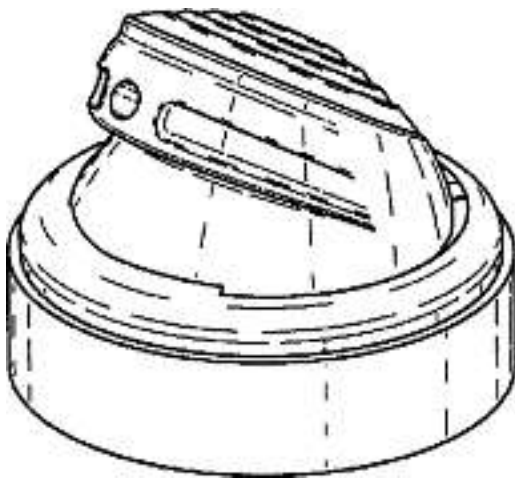
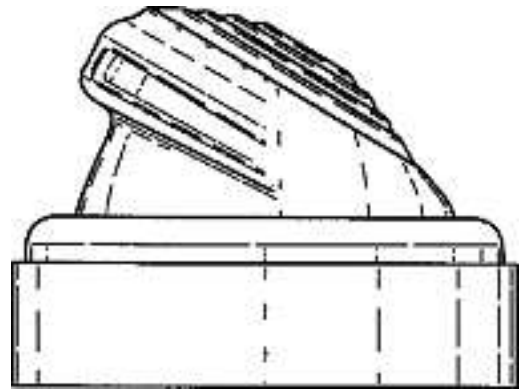

M13340

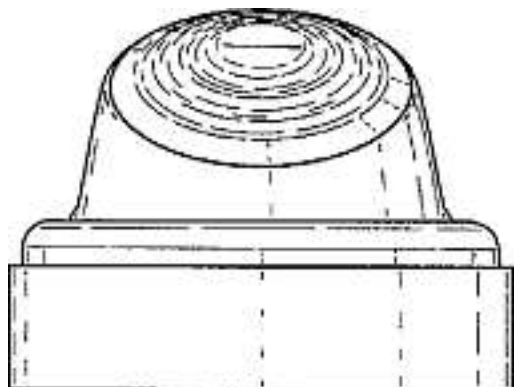

Cl. 10-01 **133 902** 05.04.2007
 1 design – montre
 Déposant: Paul Wyss, Luis Vautre 15, 2800 Delémont



Cl. 10-02 133 903 03.04.2007
1 Design – Armbanduhr
Hinterleger: Eterna AG Uhrenfabrik, Schützengasse 46,
2540 Grenchen
Designer: Christian Schwamkrug, Zell am See
Vertreter: BLUM Rechtsanwälte, 8021 Zürich



07/31/CH/ET/RD

Cl. 10-02, 10-07 133 904 04.04.2007
 6 design – montres et fonds de boîtes de montres
 Déposant: Ira Krieger, 1665 Washington Avenue, Miami
 Beach (FL 33139), US
 Mandataire: Mathieu North, 2001 Neuchâtel



1



2



3



4



5



6

Cl. 10-02 133 905 23.04.2007
 2 design – montres-bracelets
 Déposant: Montres Corum Sàrl, 1, rue du Petit-Château,
 2300 La Chaux-de-Fonds
 Designer: Severin Wunderman, Los Angeles
 Mandataire: Inteltech SA, 2001 Neuchâtel



1





2

Cl. 10-07 **133 908** 12.04.2007
 1 Design – Armband
 Hinterleger: Rolf von Burg, Hofergässli 3, 2544 Bettlach
 Beschreibung des Designs: Armband mit auf der Oberseite angebrachten kratzfesten Elementen wie z.B. Saphire, Saphirplaquettes mit Decor etc. Die Elemente sind farblich unabhängig. Die Elemente können die Oberfläche ganz oder nur teilweise bedecken.



1

Cl. 10-07 **133 909** 17.04.2007
 3 design – montres
 Déposant: Dent & Co. AG, Zugerstrasse 77, 6340 Baar
 Designer: Rodolphe Cattin, Neuchâtel
 Mandataire: INFOSUISSE Information Horlogère et Industrielle, 2302 La Chaux-de-Fonds

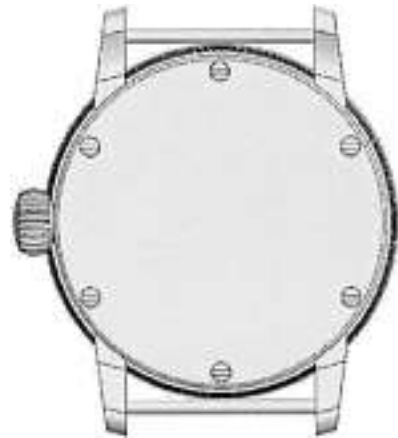

1



2

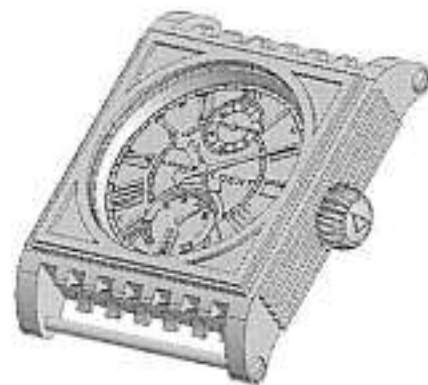
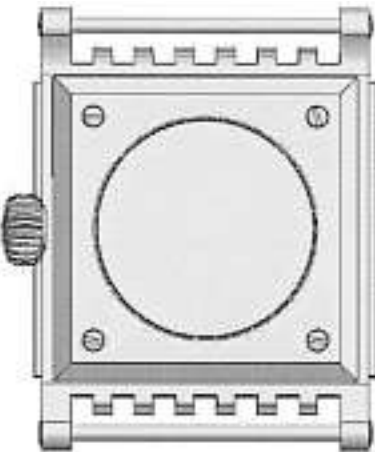
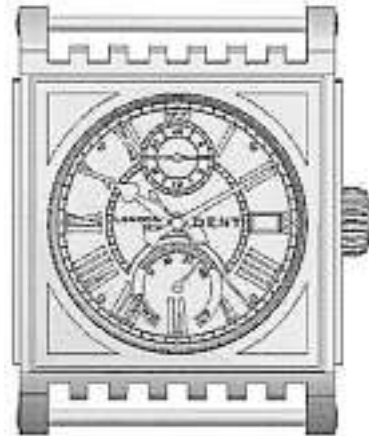

3



Cl. 10-07 **133 910** 17.04.2007
 2 design – montre, bracelet
 Déposant: ROLEX SA, rue François-Dussaud 3-5-7,
 1211 Genève 26
 Designer: Maria Cristina Calvani, Cognoy
 Mandataire: Bugnion S.A., 1211 Genève 12 - Champel

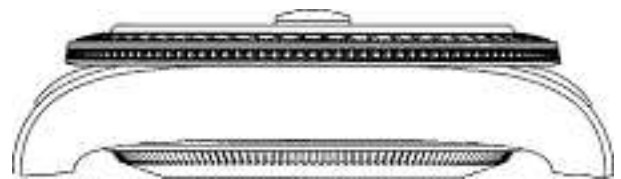
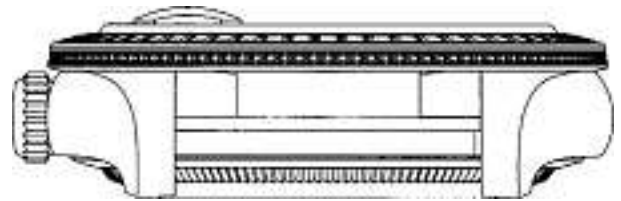
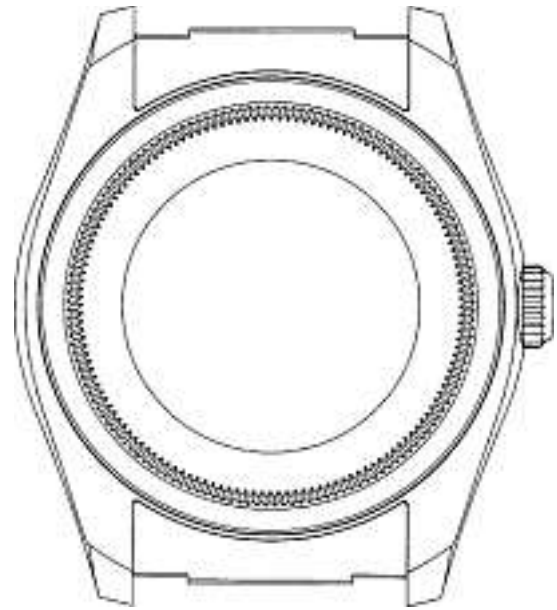
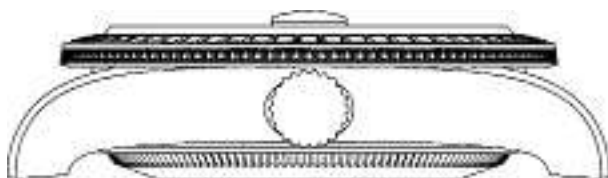
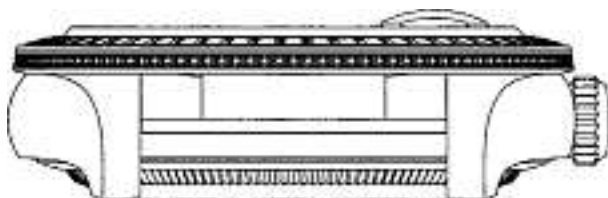
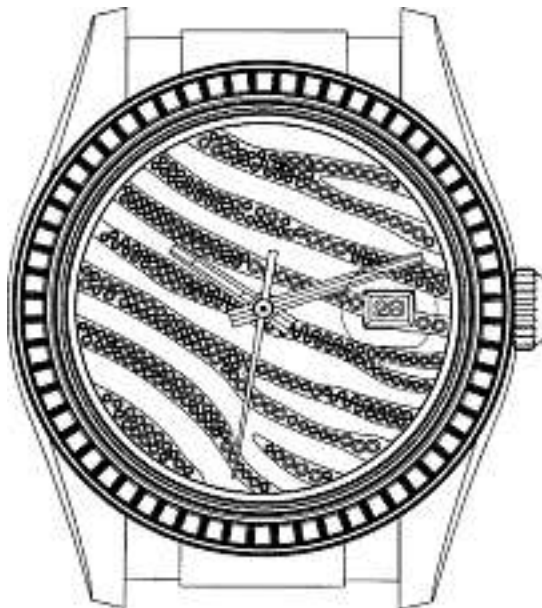
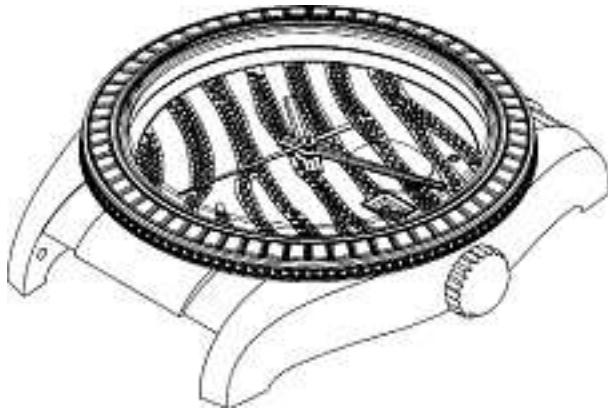

1

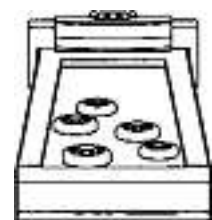
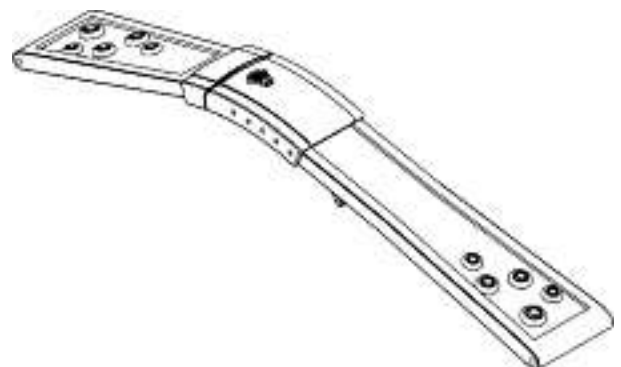

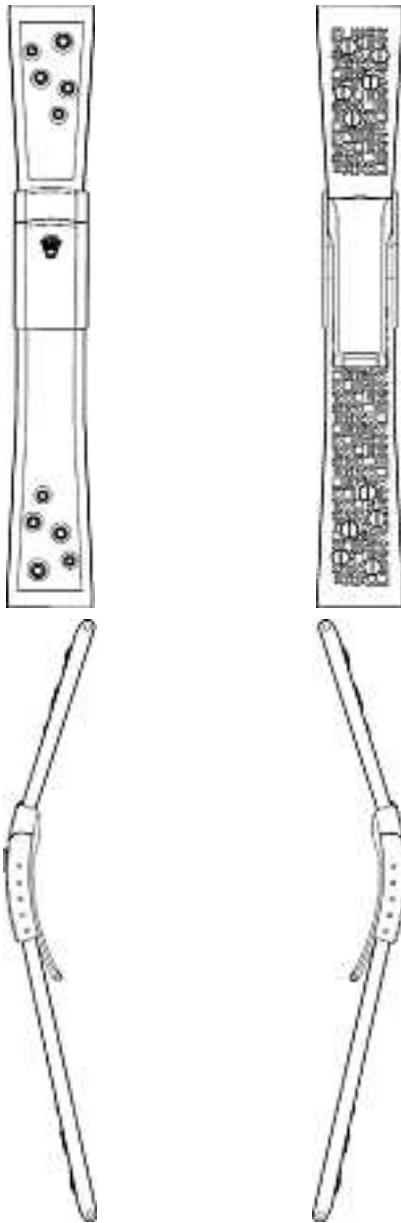

2

Cl. 11-01 **133 911** 11.04.2007
30 design – bagues, bracelets, boucles d'oreille, pendentifs
Déposant: de Grisogono S.A., 176bis, Route de Saint-Julien,
1228 Plan-les-Ouates
Designer: Fawaz Gruosi, Prangins



CH_B_07_01



CH_B_07_02



CH_B_07_03





CH_B_07_04

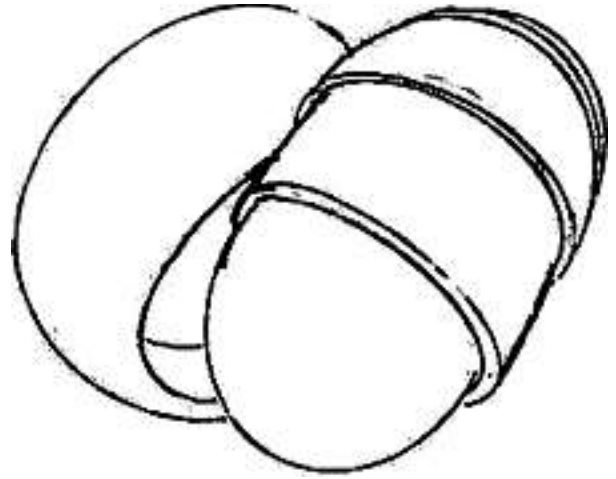

CH_B_07_05

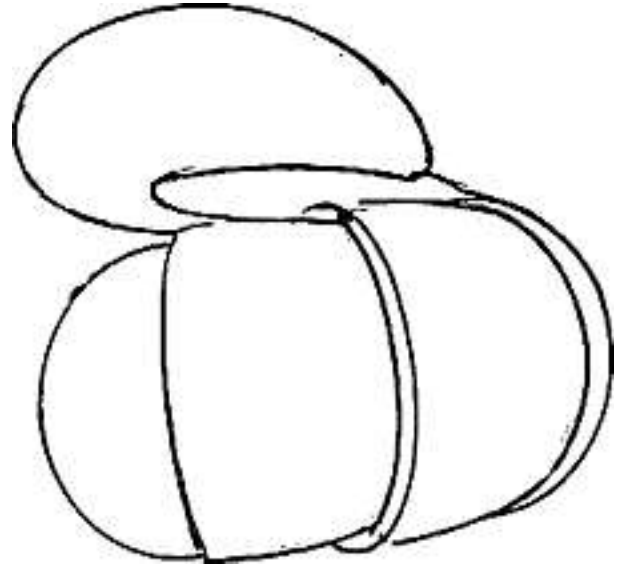

CH_B_07_06

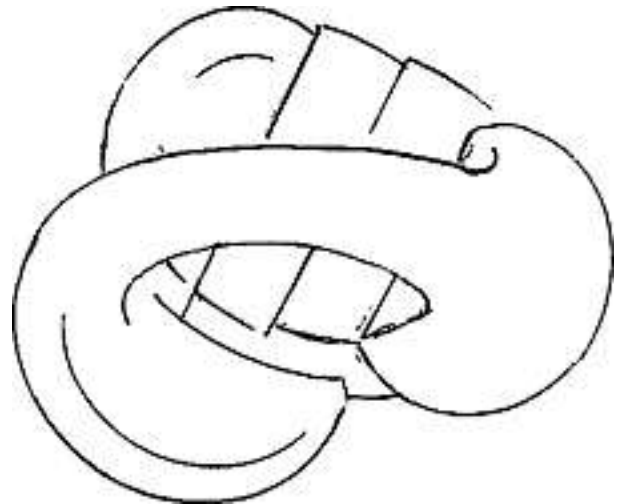

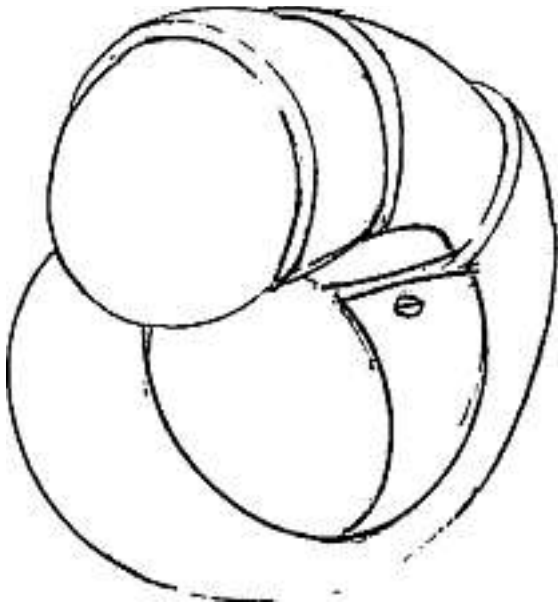

CH_B_07_09

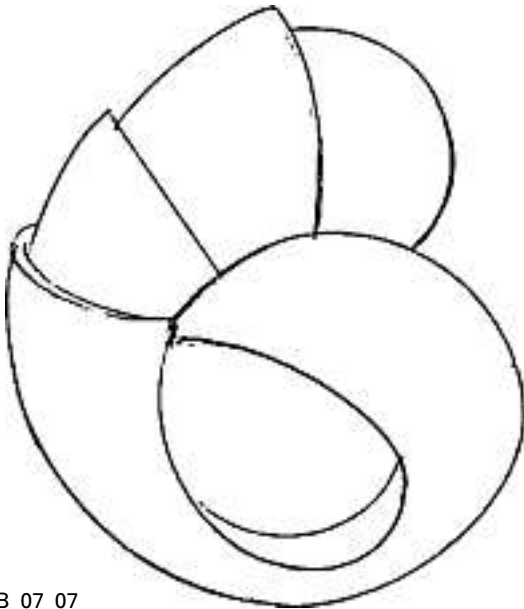

CH_B_07_07



CH_B_07_08





CH_B_07_10



CH_B_07_11



CH_B_07_13



CH_B_07_12



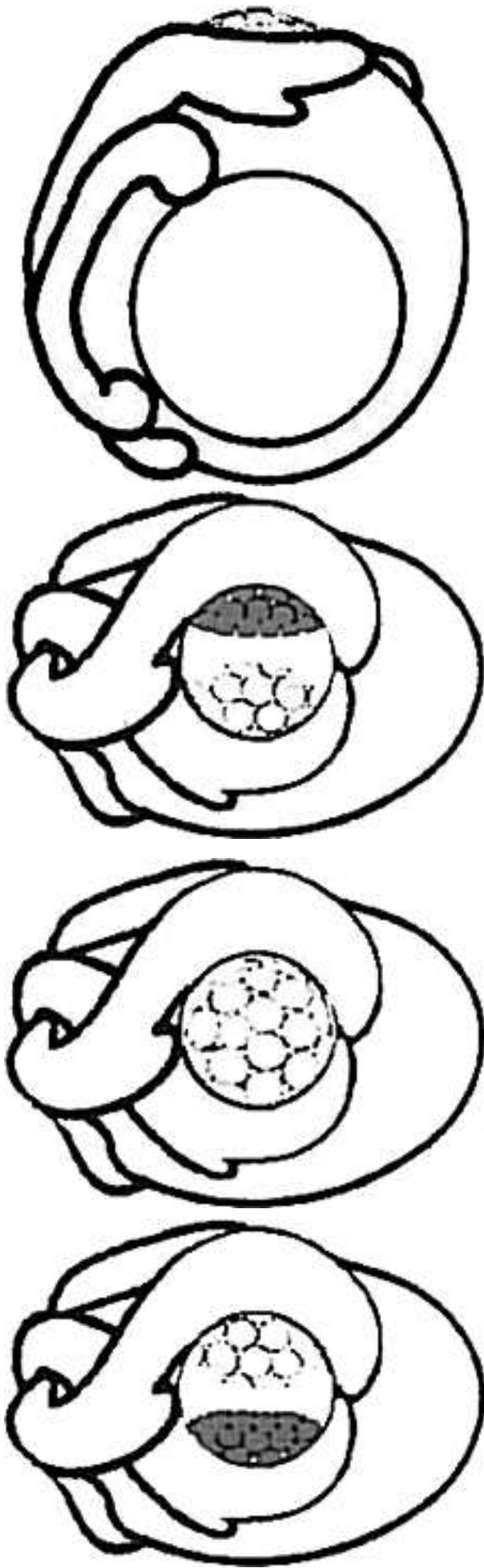

CH_B_07_14





CH_B_07_16



CH_B_07_15





CH_B_07_17



CH_B_07_20



CH_B_07_18



CH_B_07_21



CH_B_07_19





CH_B_07_22



CH_B_07_26



CH_B_07_23



CH_B_07_27



CH_B_07_24



CH_B_07_25





CH_B_07_28

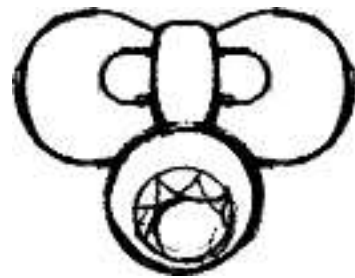
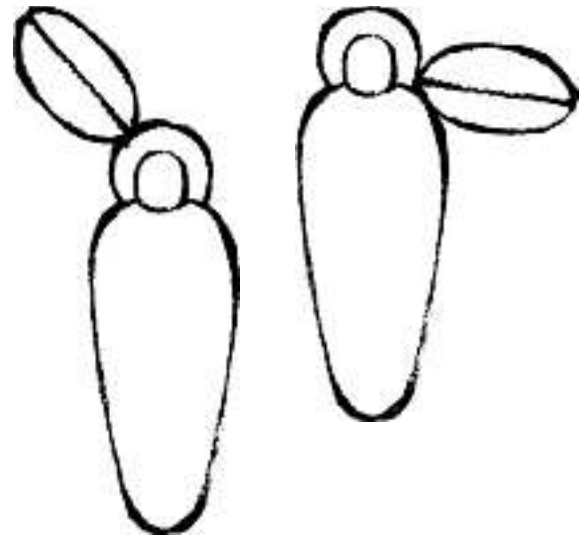
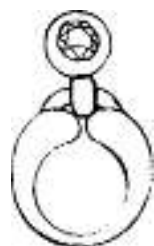

CH_B_07_29

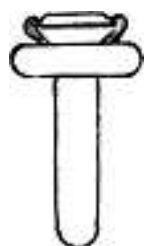
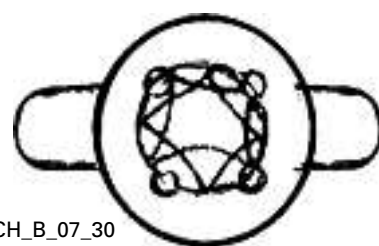

CH_B_07_30

Cl. 11-01 133 912 17.04.2007
 2 Design – Ringe
 Hinterleger: David Barandun, Brändligasse 36, 7000 Chur



Schüsselring



Drilling-Ring

Cl. 11-02 133 913 16.04.2007
 1 Design – Duftlampe
 Hinterleger: Christian Imhof, Strassburgerallee 62, 4055 Basel



1

Cl. 11-05 133 914 27.04.2007
 15 Design – Fahnen, Wimpel
 Hinterleger: Eric Dill, Mottastrasse 14A, 3005 Bern

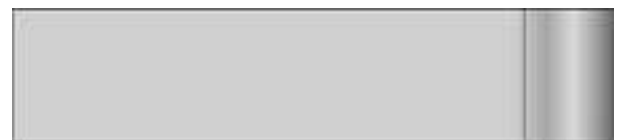
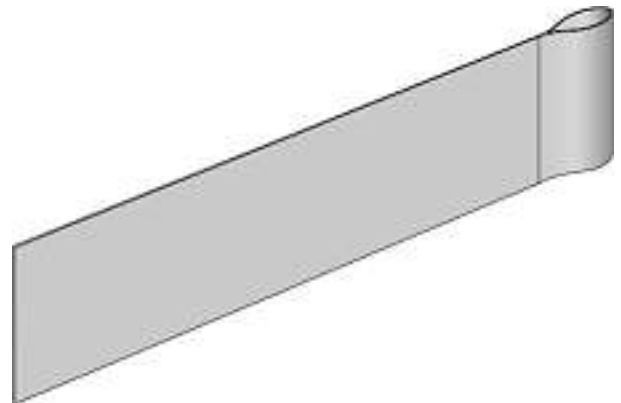

ff_01

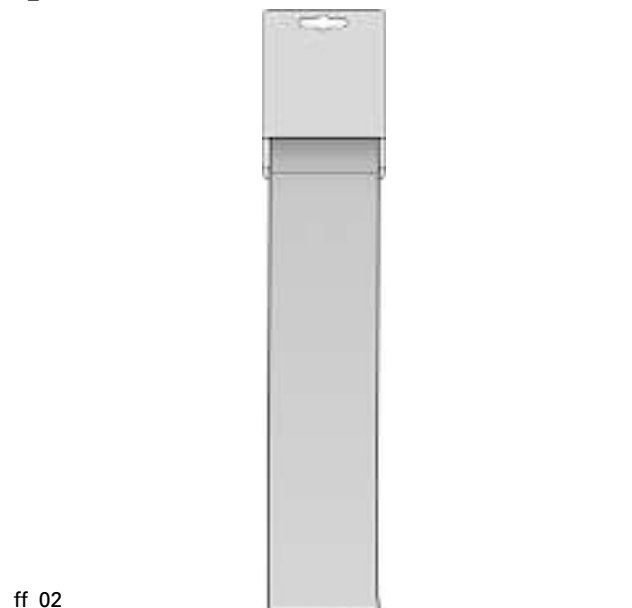

ff_02

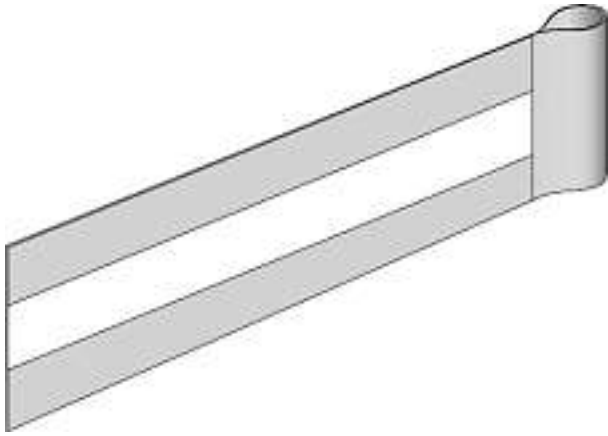

ff_03

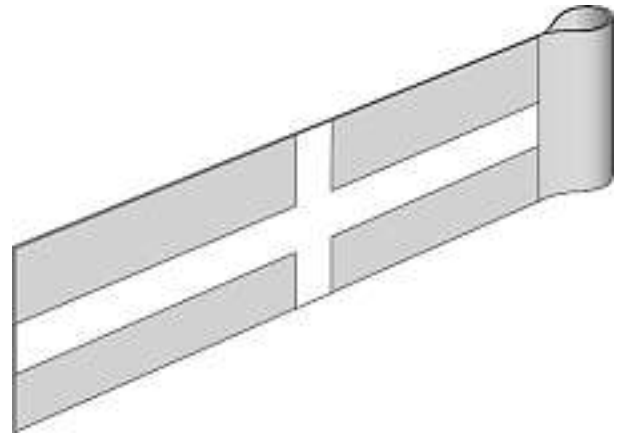

ff_07

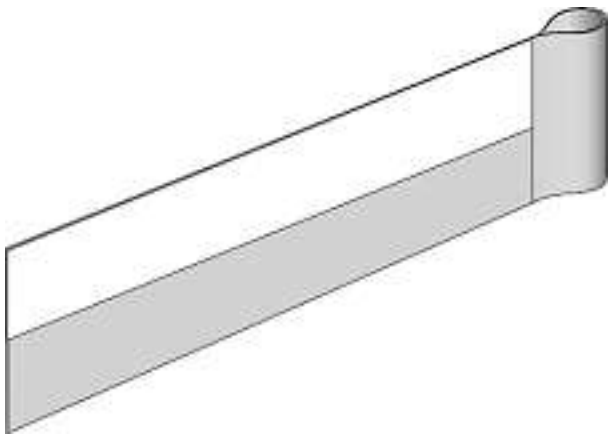

ff_04



ff_08

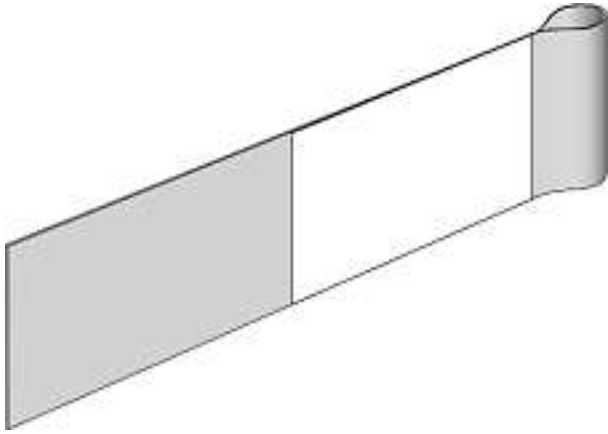

ff_05



ff_09

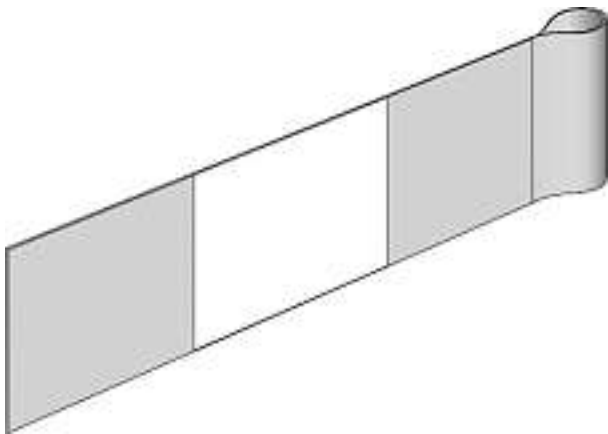

ff_06

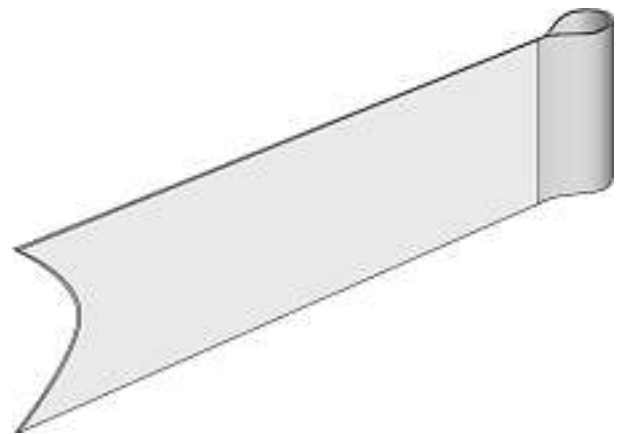

ff_10

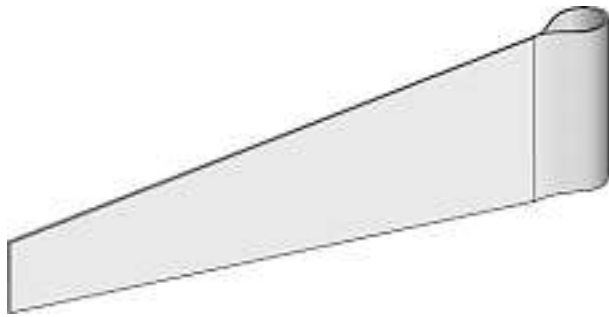

ff_11

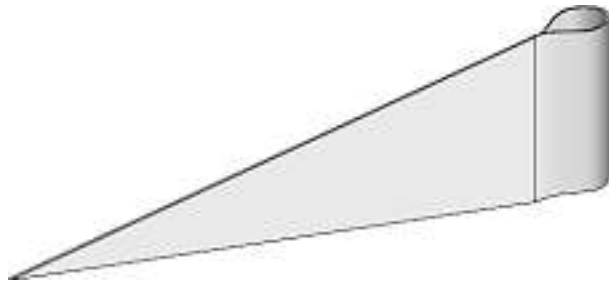

ff_12

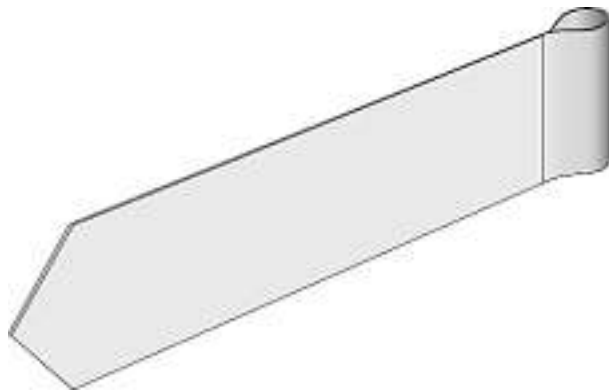

ff_13

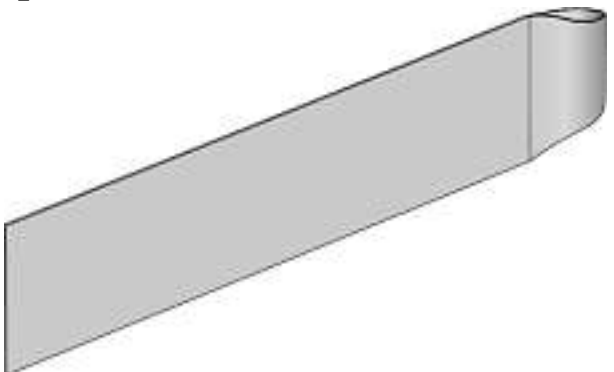

ff_14

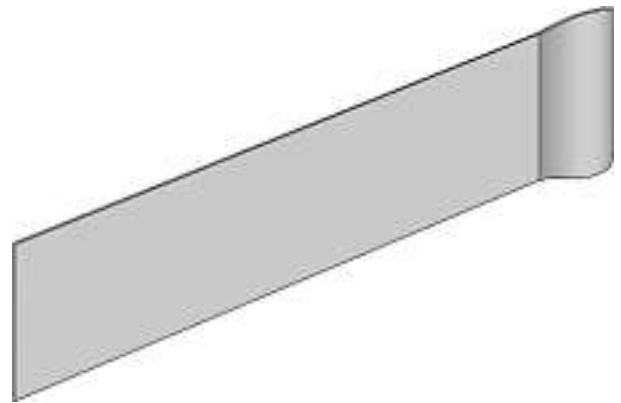
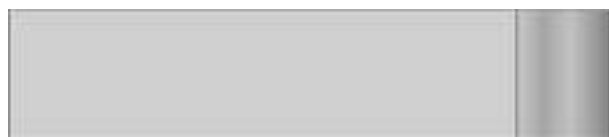

ff_15



Cl. 12-15 **133 915** 19.04.2007
 1 Design – Fahrzeugreifen
 Hinterleger: Continental Aktiengesellschaft, Vahrenwalder
 Strasse 9, 30165 Hannover, DE
 Designer: Akif Celik, Hannover; Michael Jansen, Waldfeucht-
 Haaren
 Vertreter: Bovard AG, 3000 Bern 25
 Priorität: EM, 09.02.2007

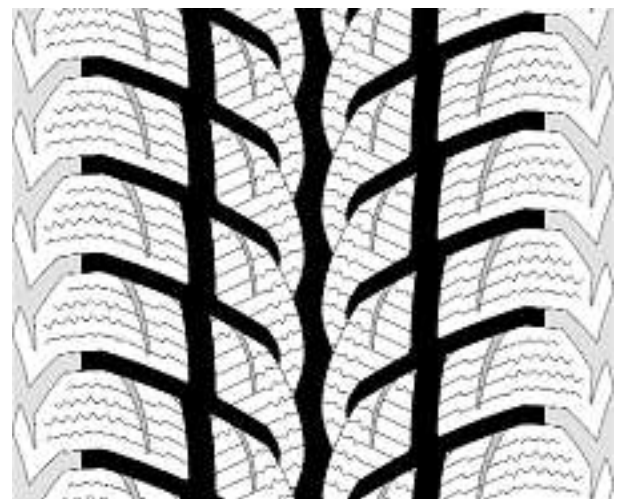

1

Cl. 13-03 **133 916** 20.04.2007
 12 Design – Kompaktstarter und Wendestarter
 Hinterleger: Siemens Aktiengesellschaft, Wittelsbacherplatz 2,
 München, DE
 Designer: Thomas Detemple, Planegg; Josef Graf, Hahnbach;
 Peter Trautwein, München
 Vertreter: Siemens Schweiz AG, 8047 Zürich
 Priorität: EM, 05.03.2007

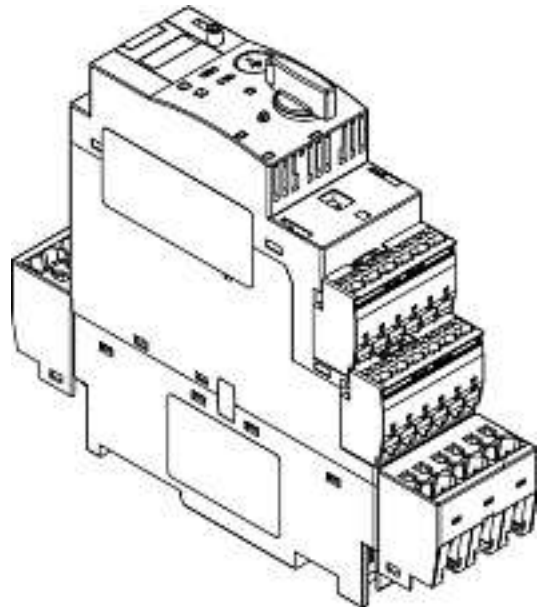
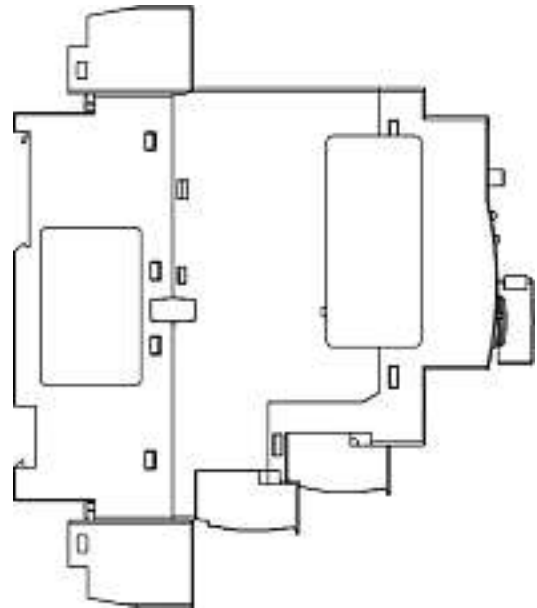
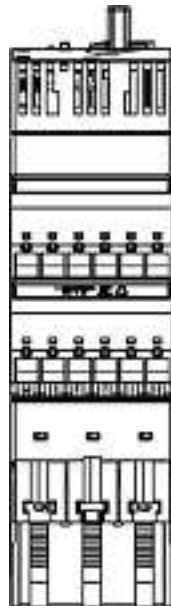
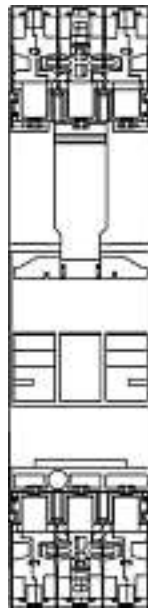
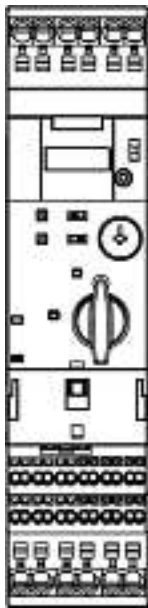

1

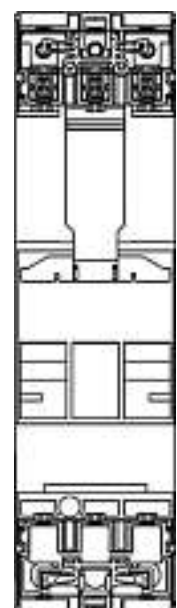
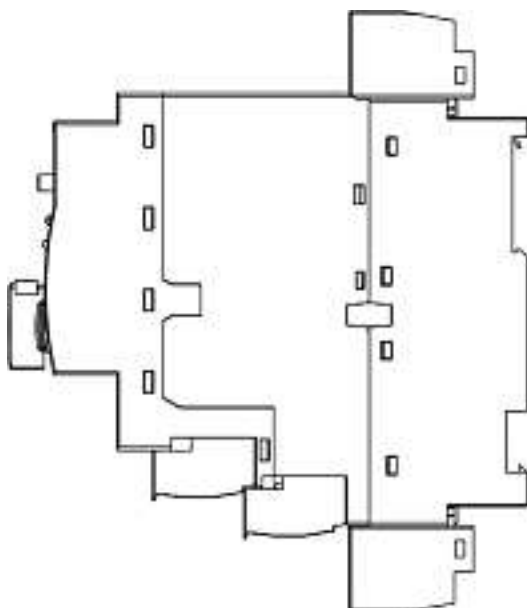

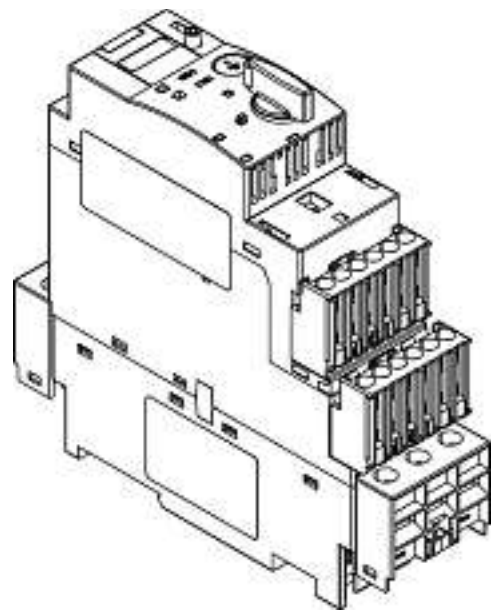
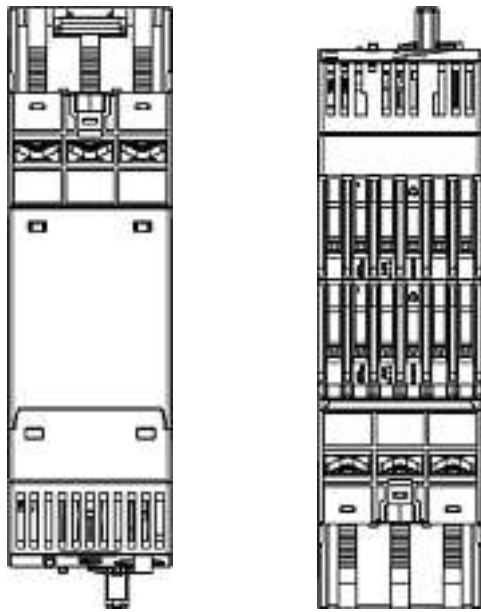

2

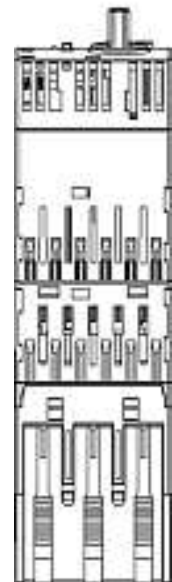
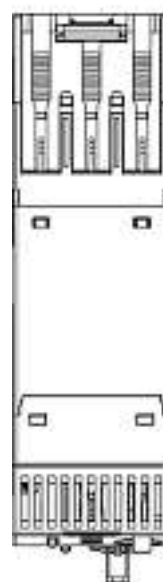
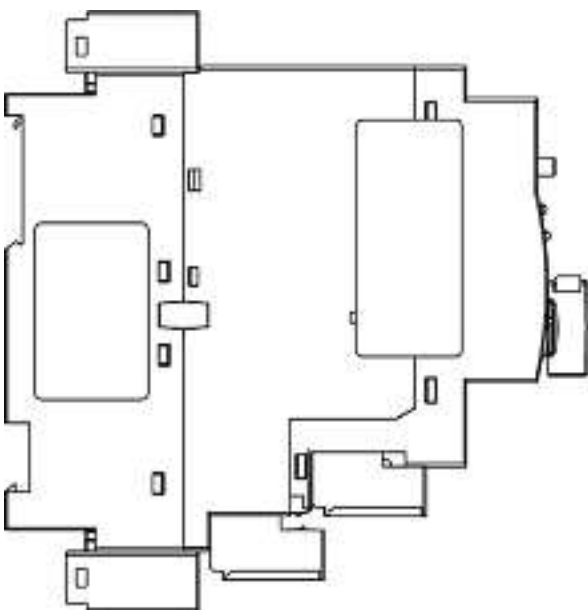
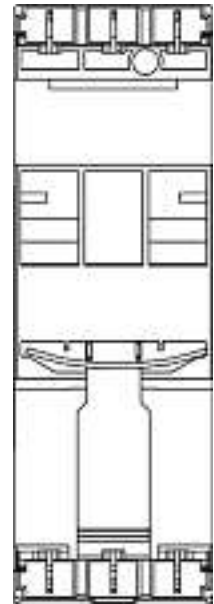
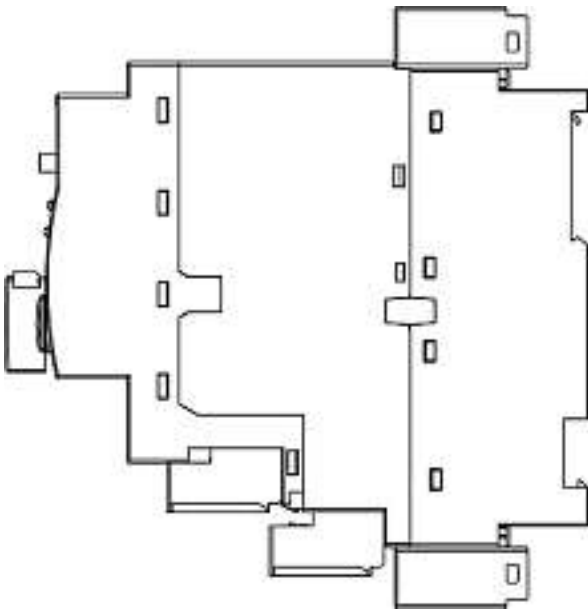

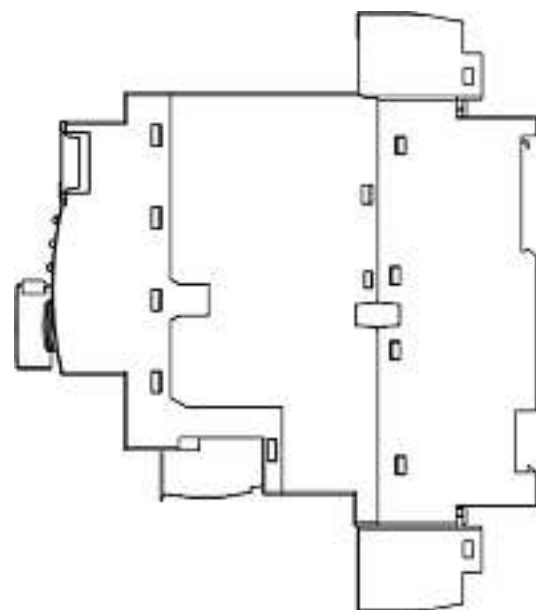
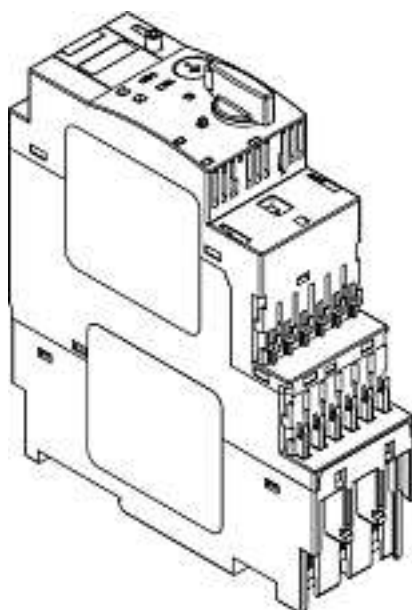
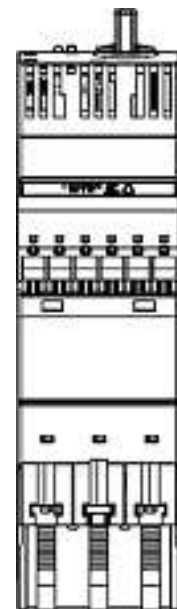
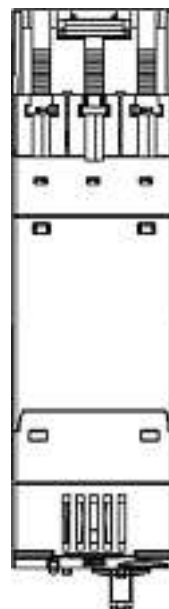
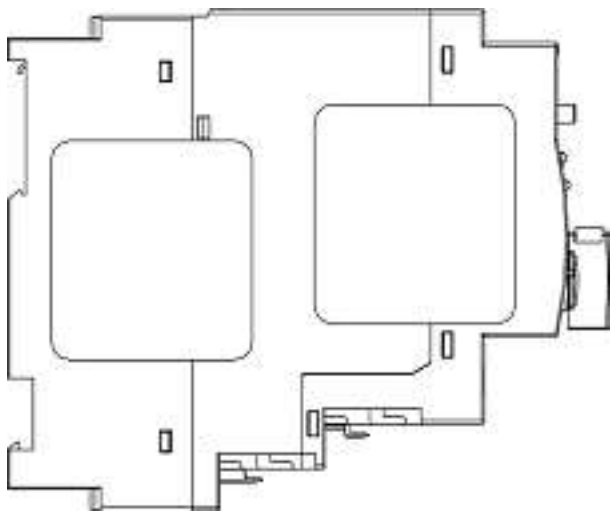
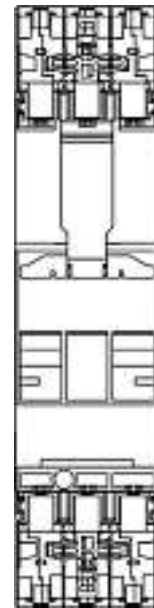
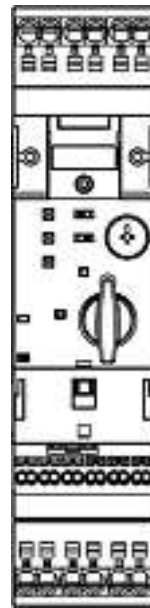
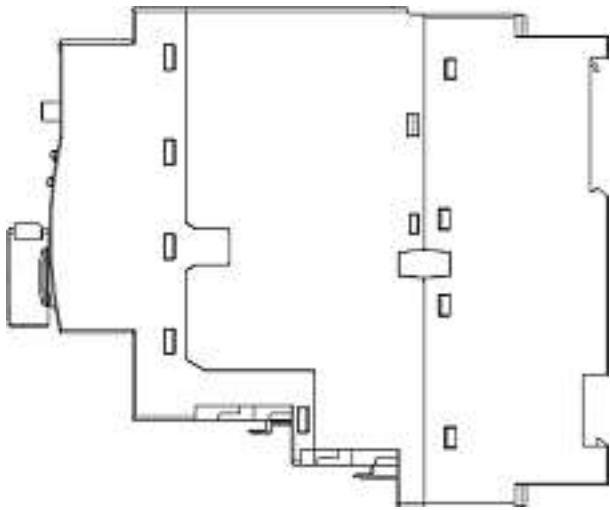

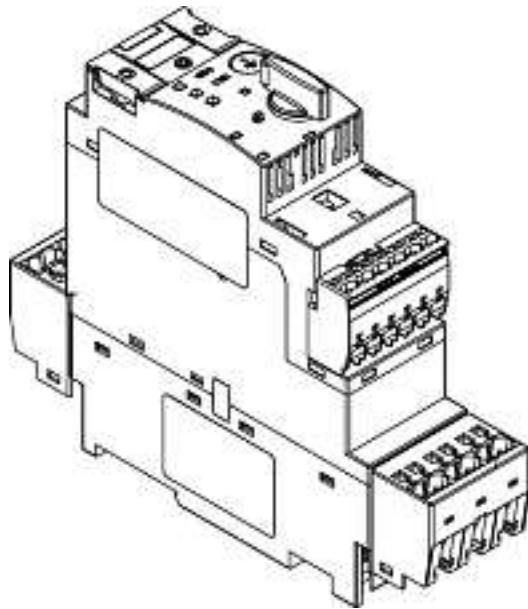
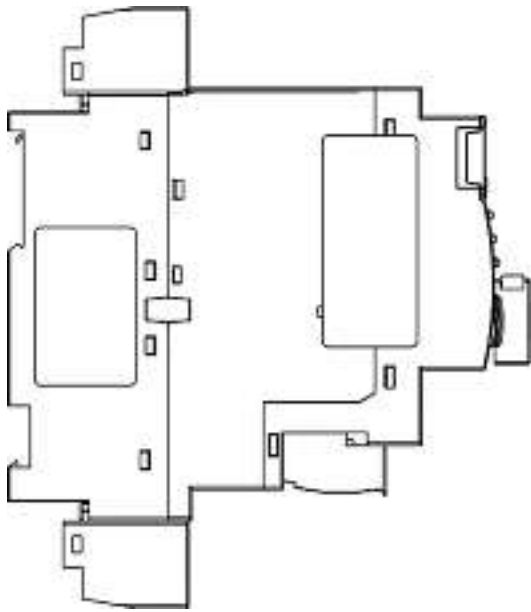

4

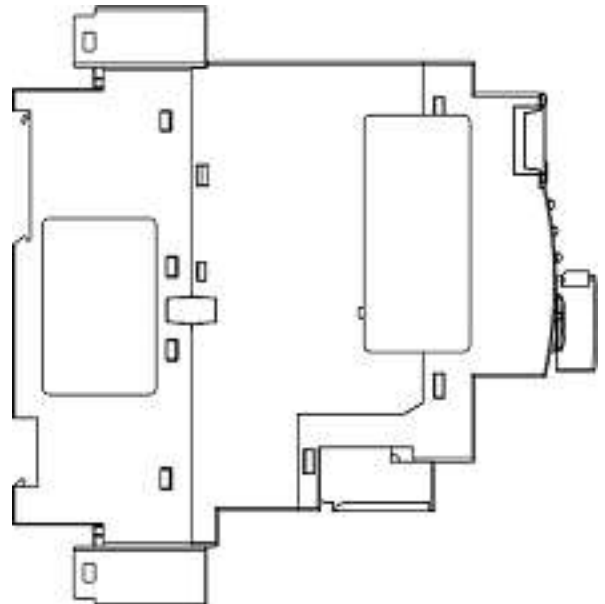
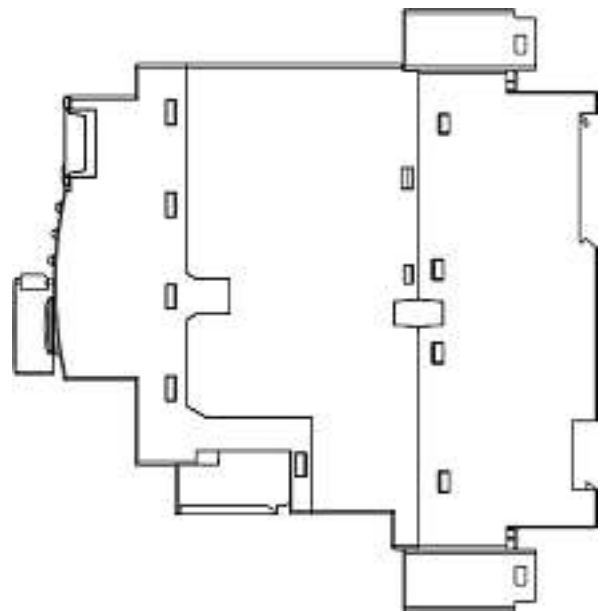
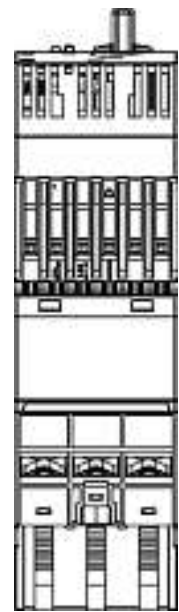
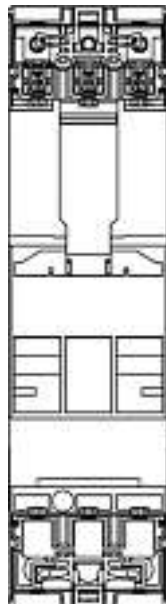
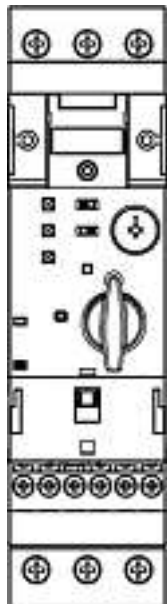

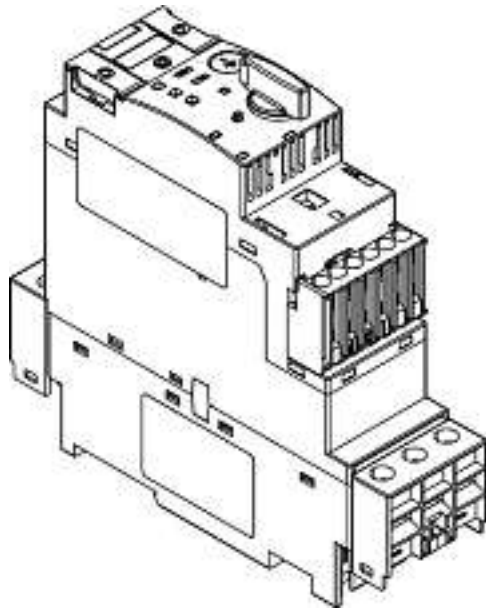

5

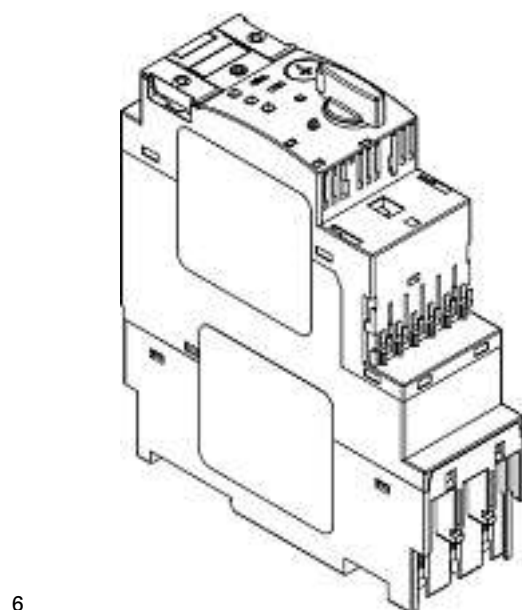
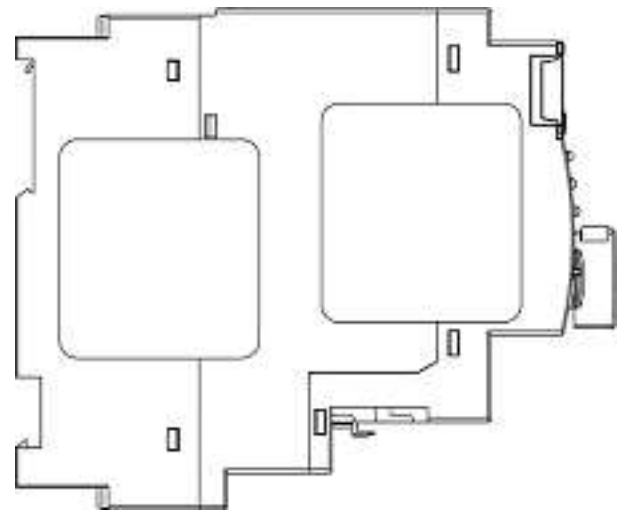
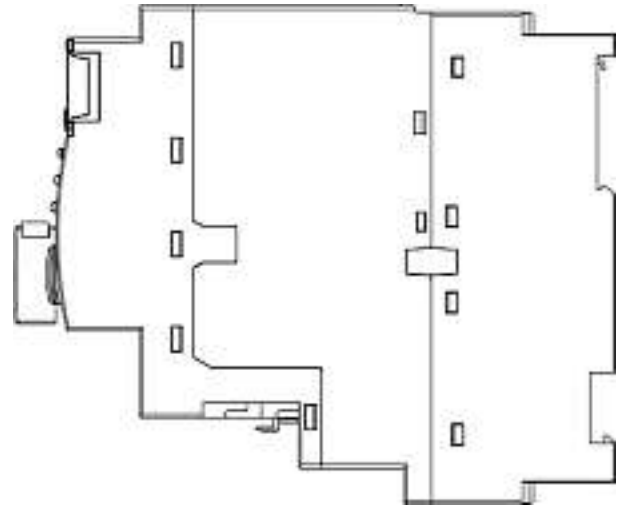
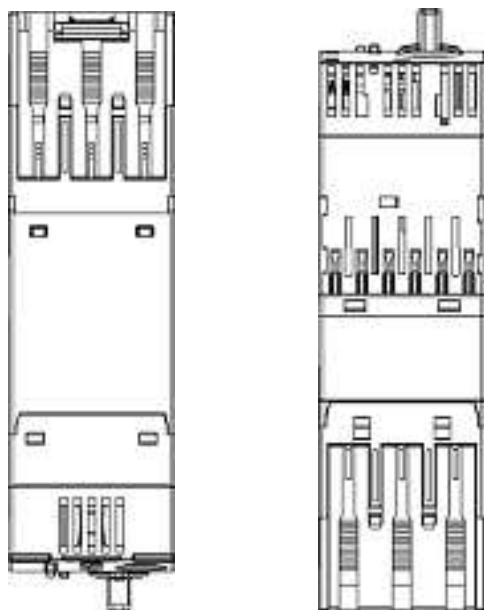
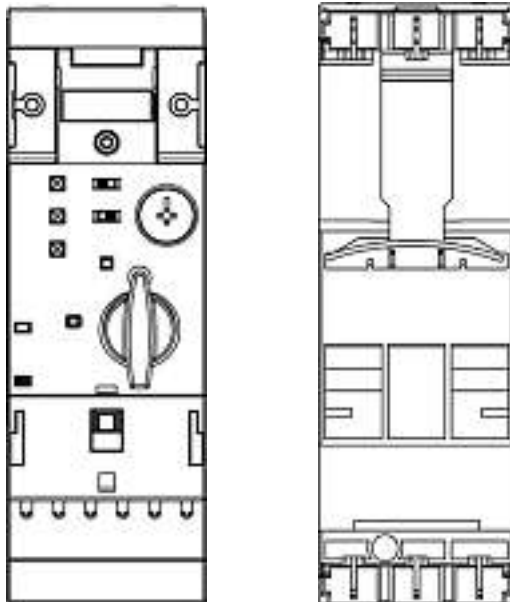

6

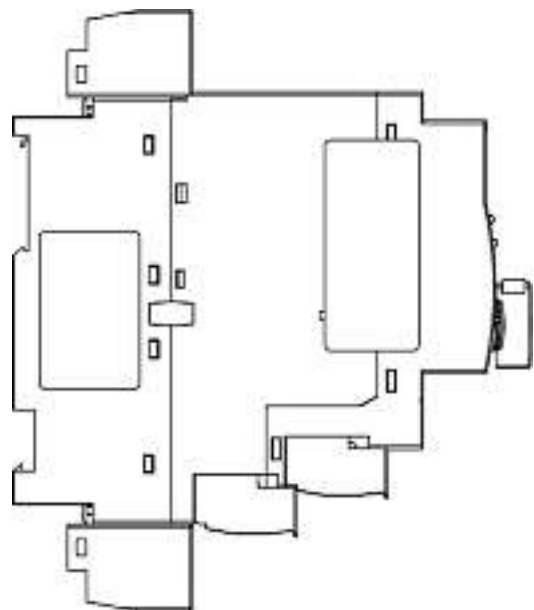
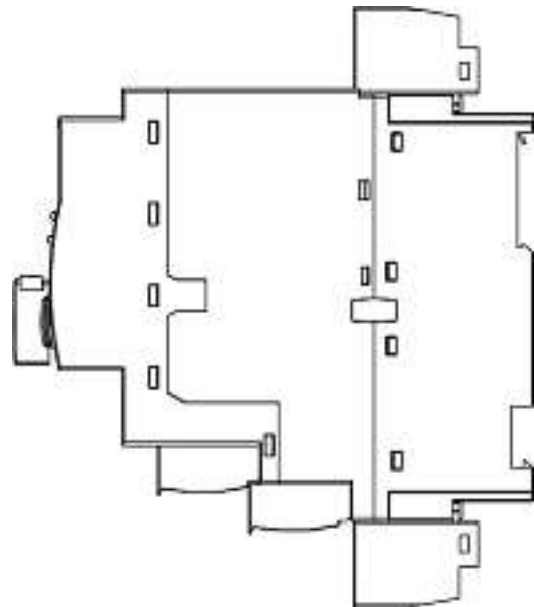
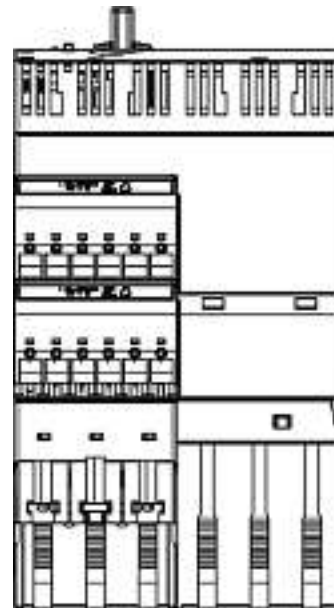
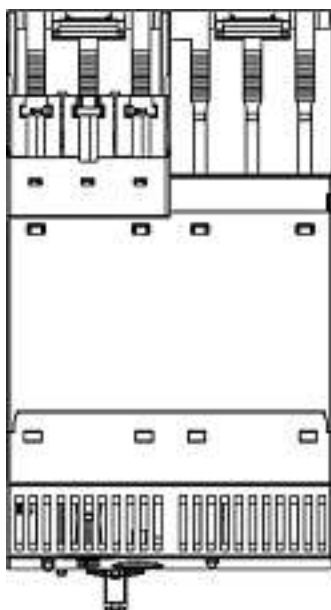
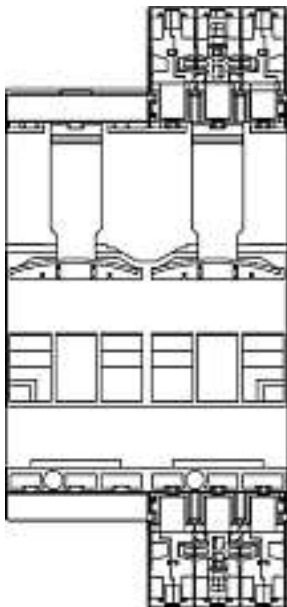
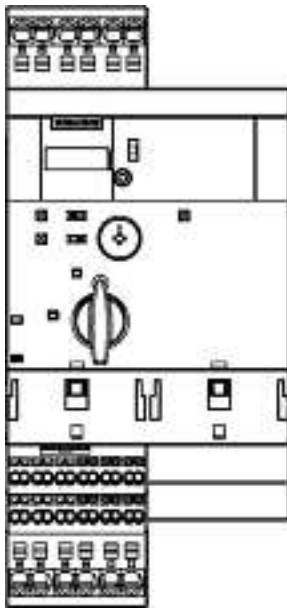

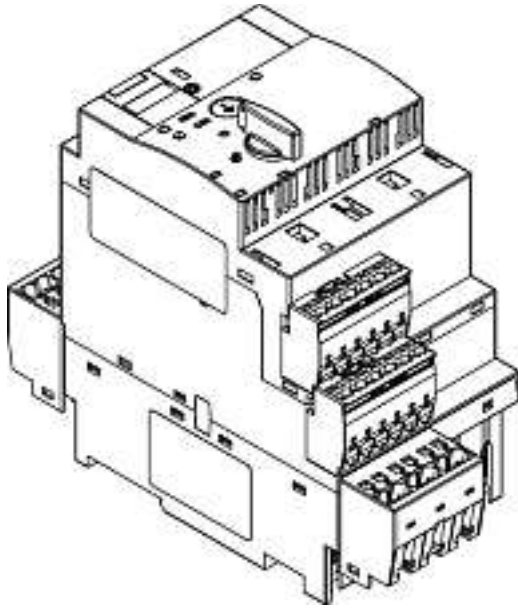

7

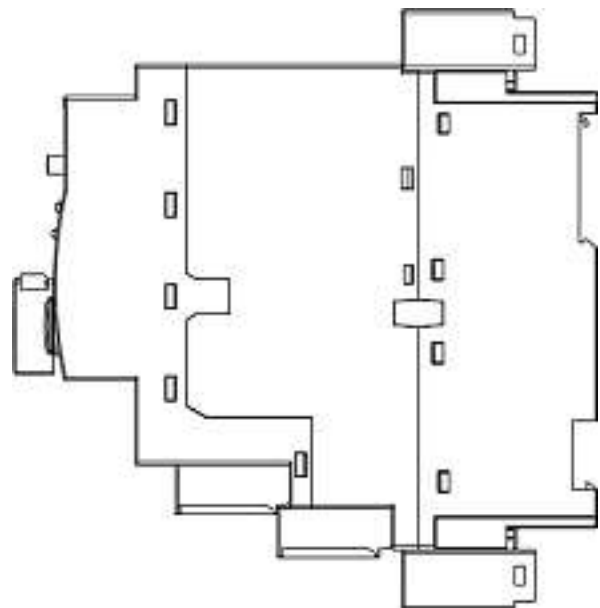
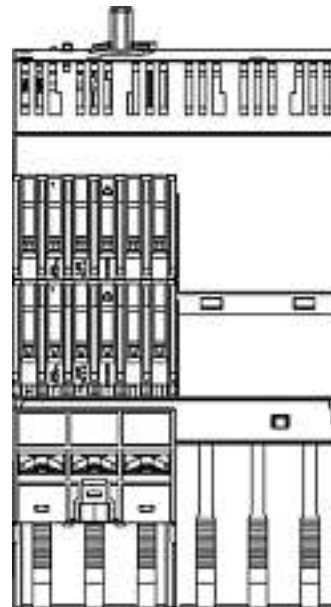
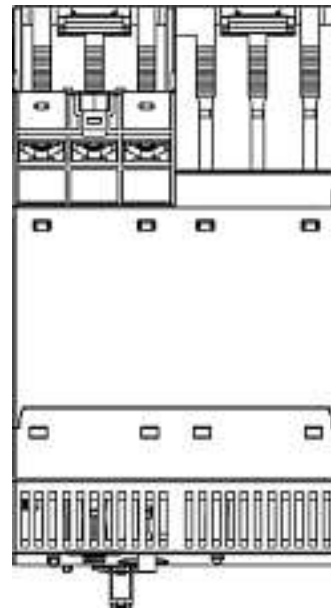
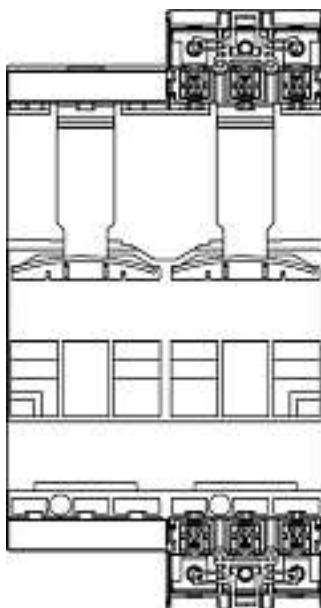
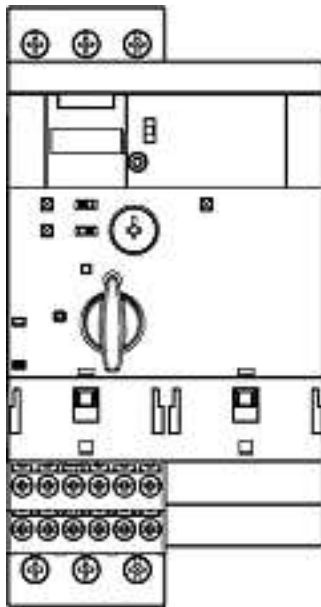

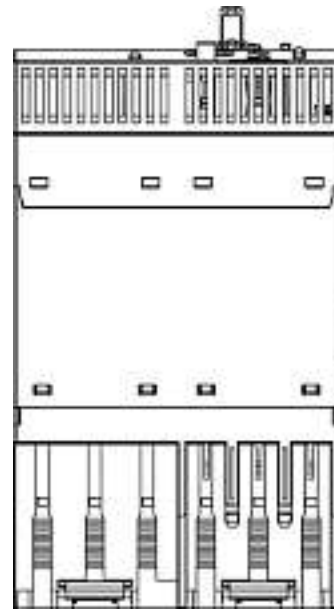
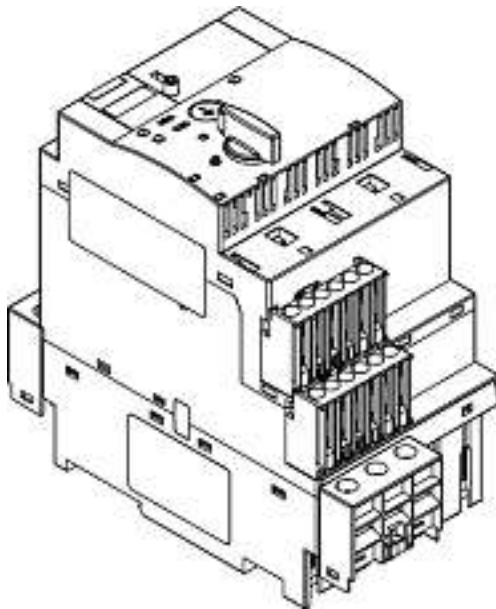
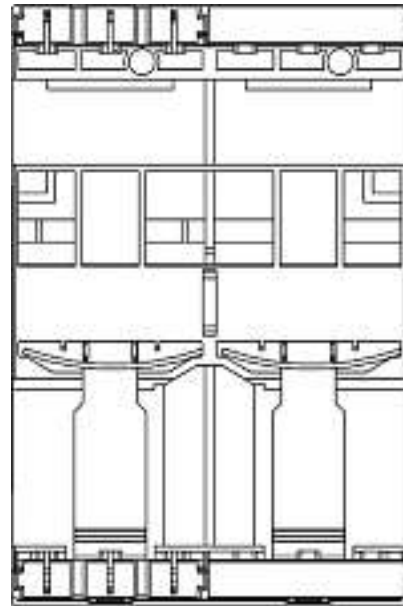
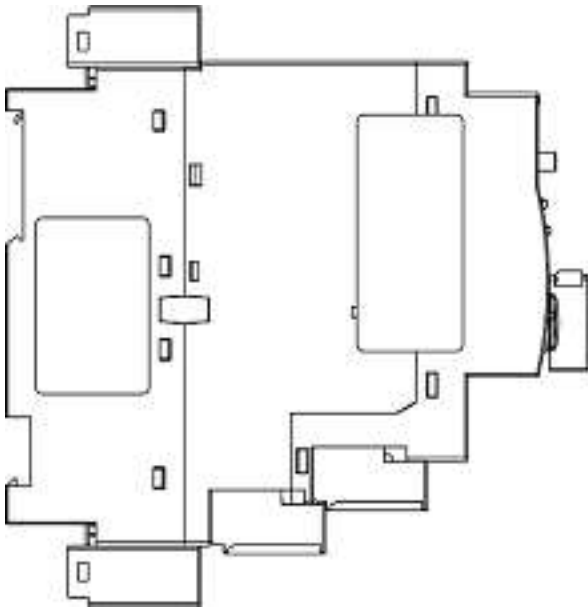

8

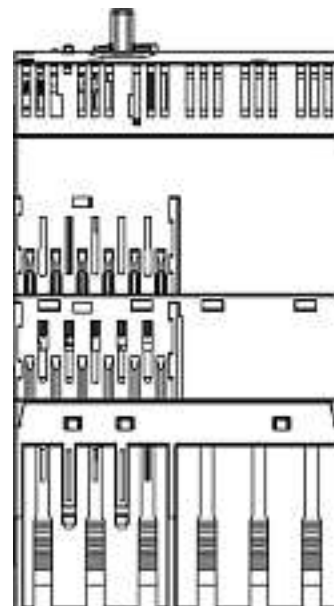
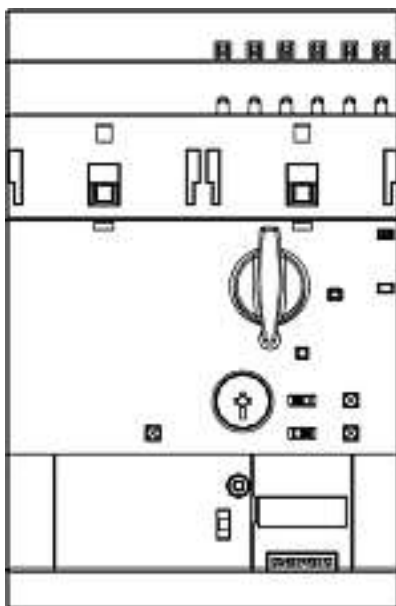

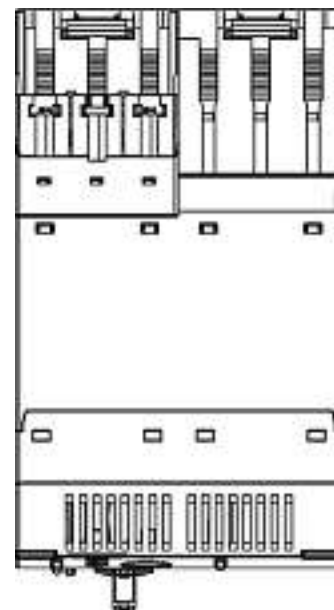
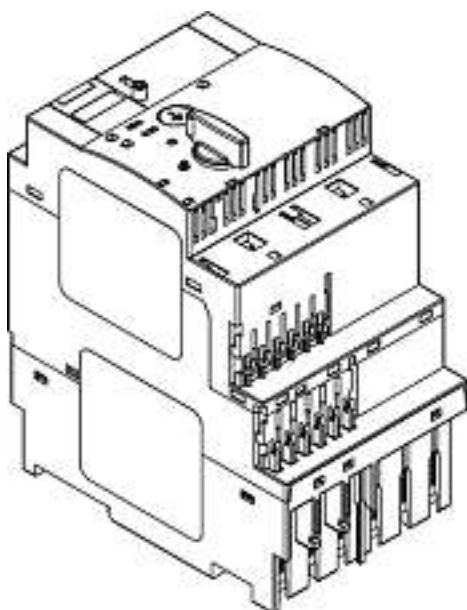
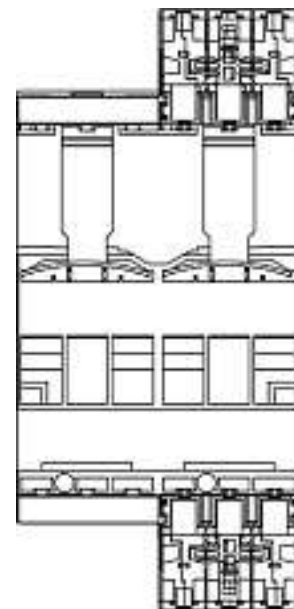
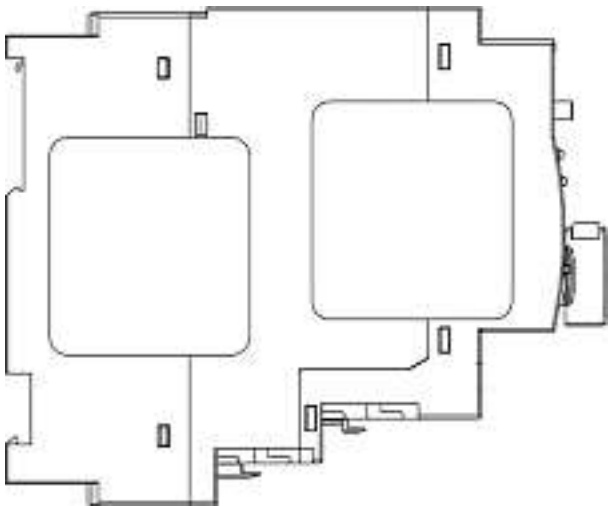
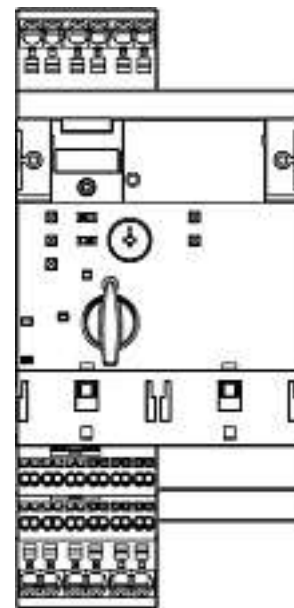
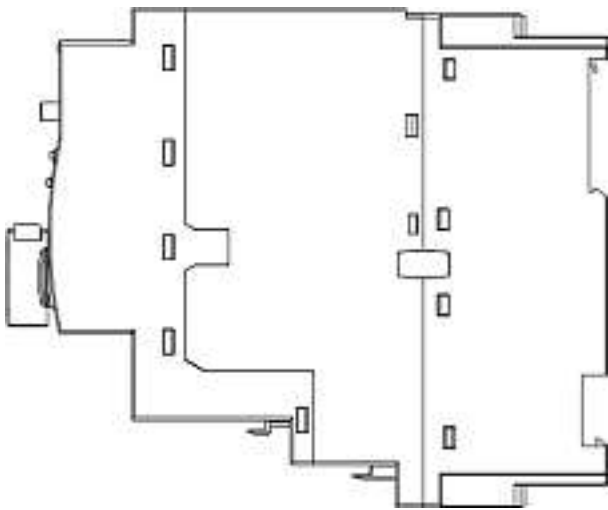

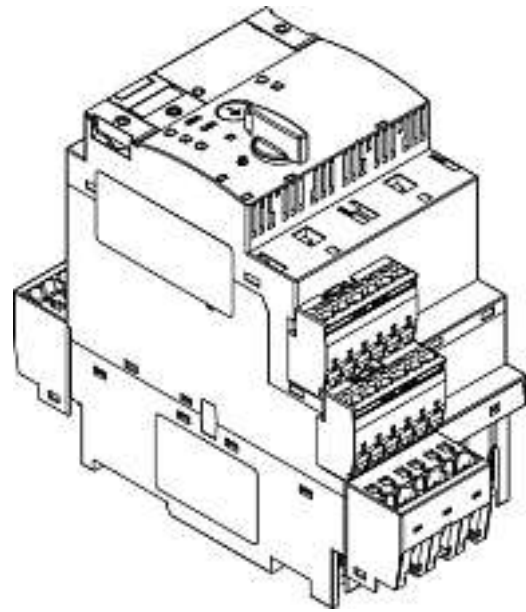
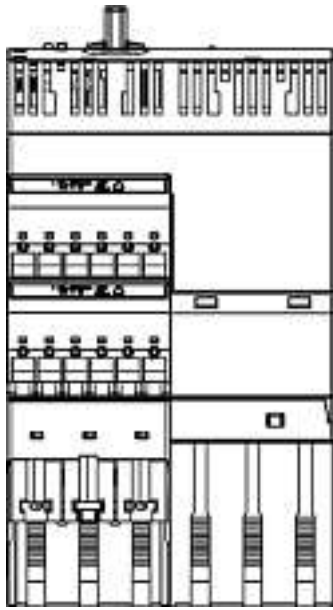

10

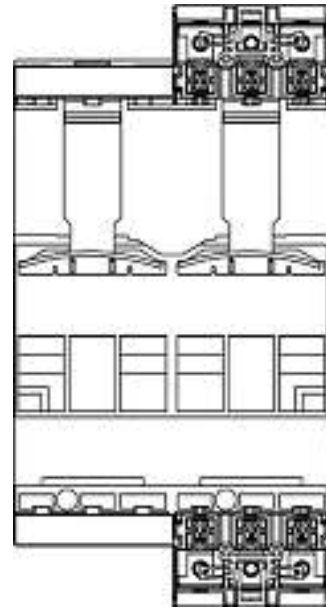
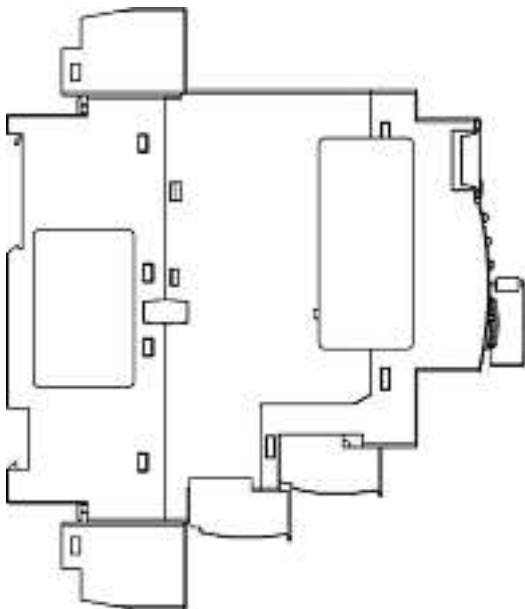
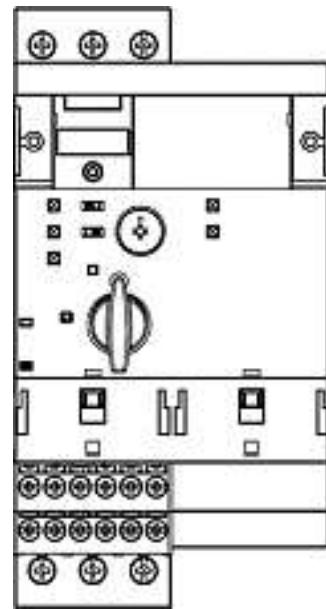
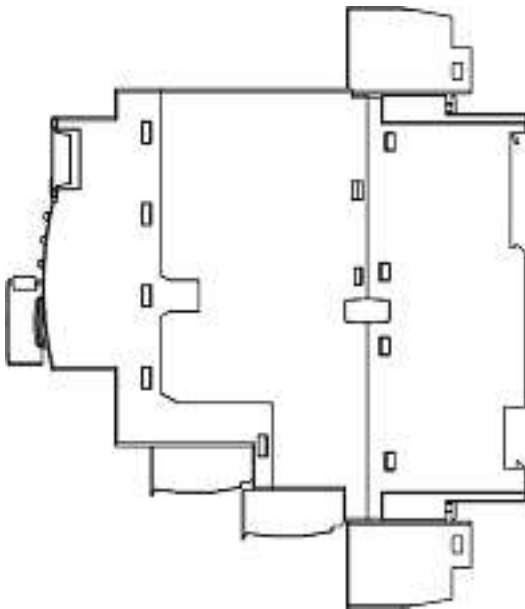

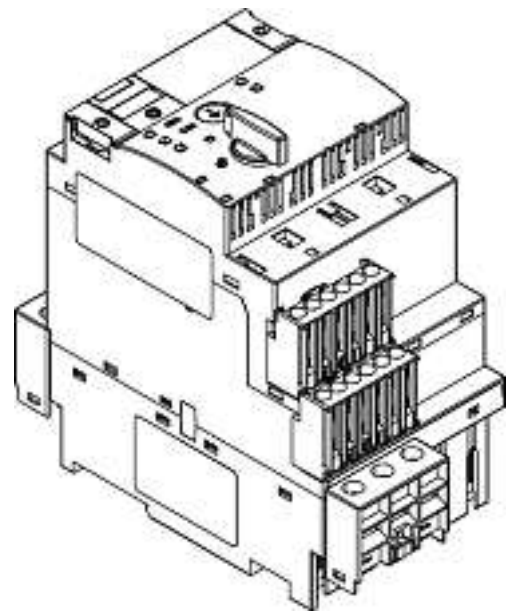
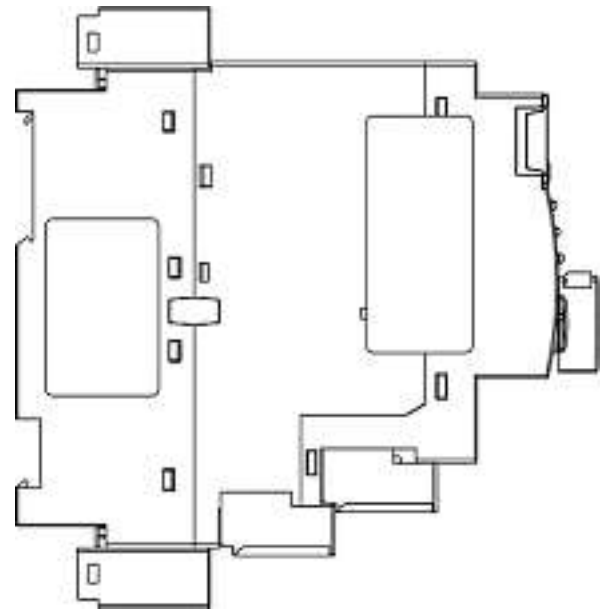
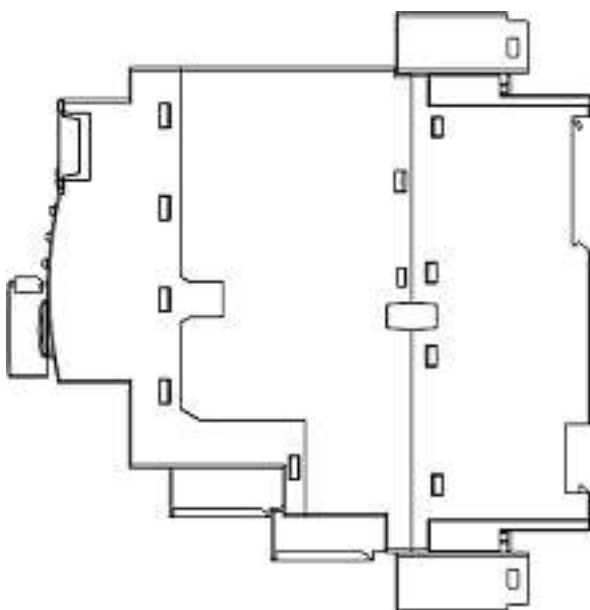
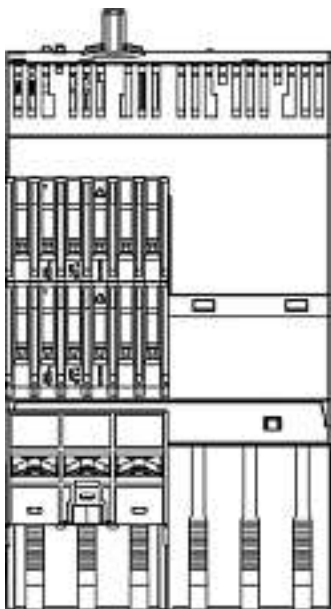
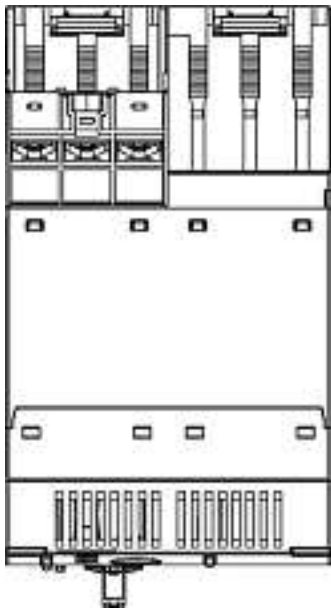

11

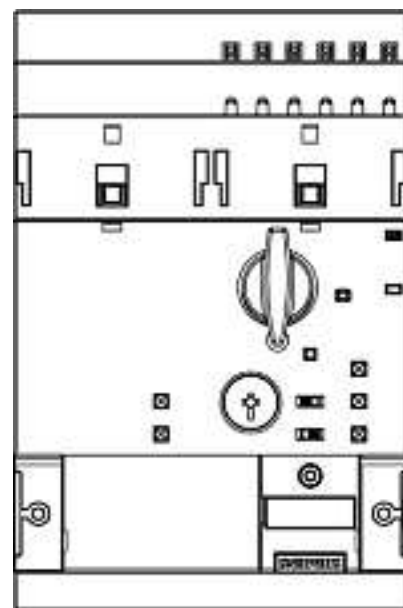

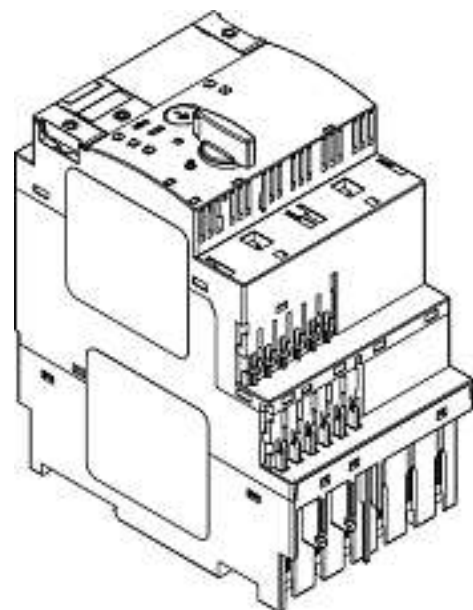
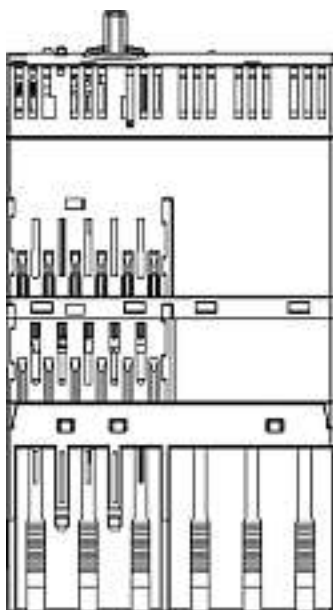
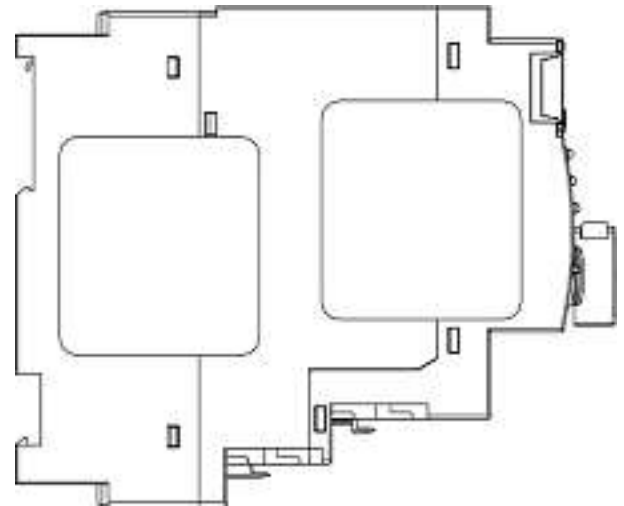
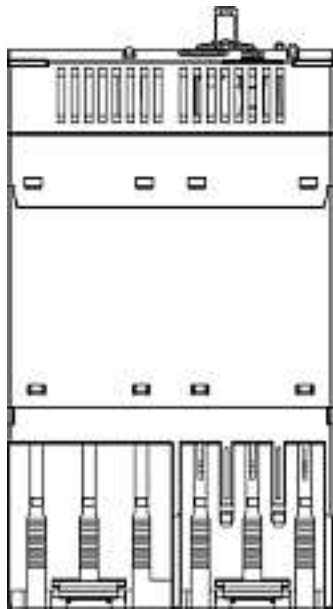
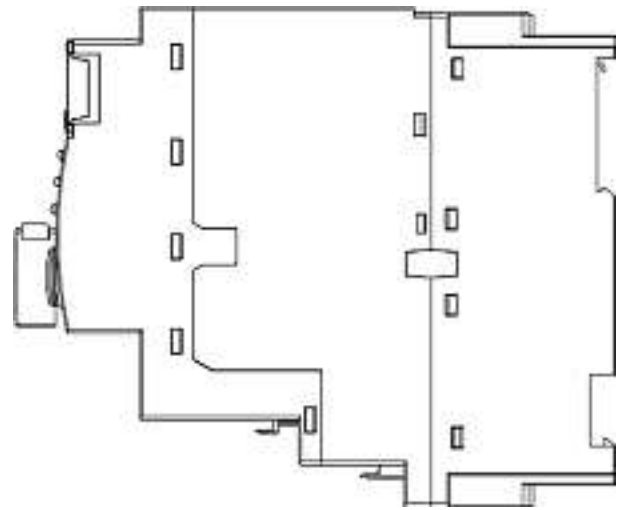
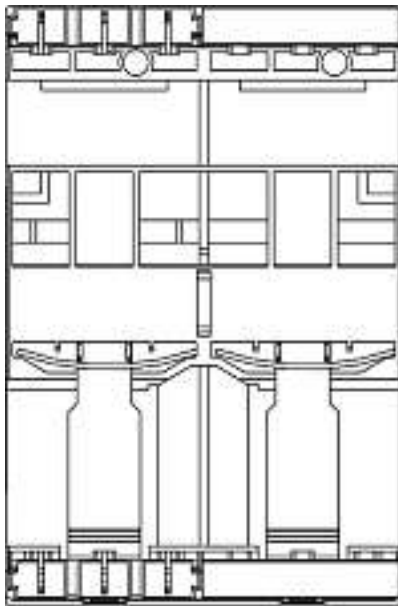

Cl. 14-01 133 917 18.04.2007
7 Design – Lautsprecher
Hinterleger: Ghost GmbH für objektorientierte Systeme und
Technologien, Technoparkstrasse 1, 8005 Zürich
Designer: Daniel Humbel, Zürich

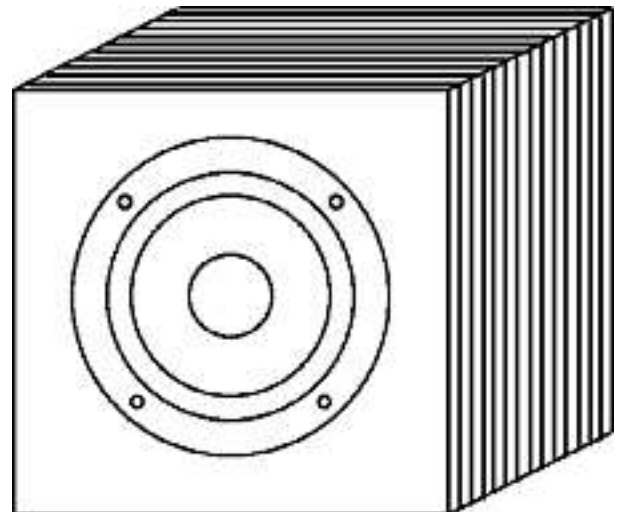
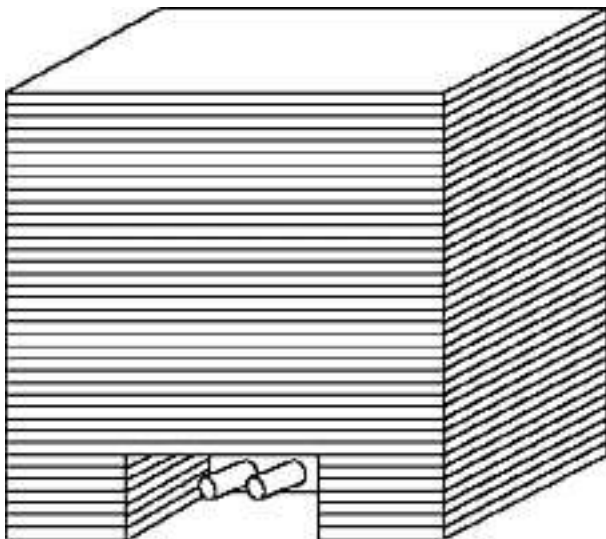
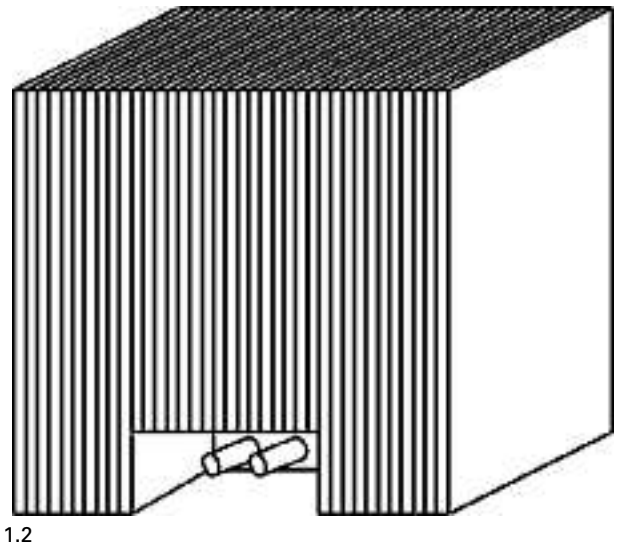
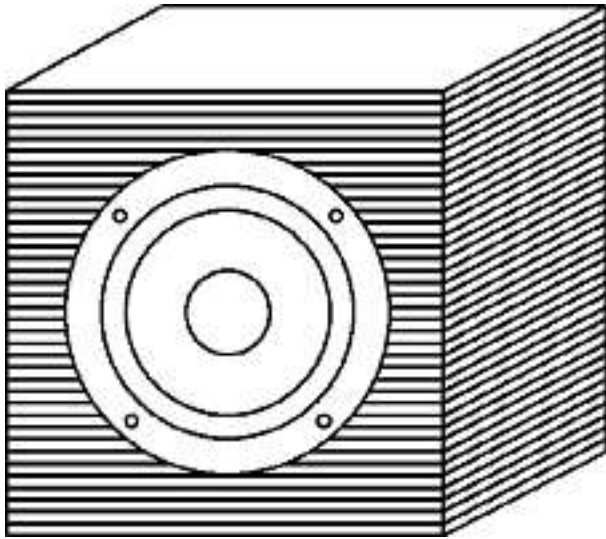

1.1

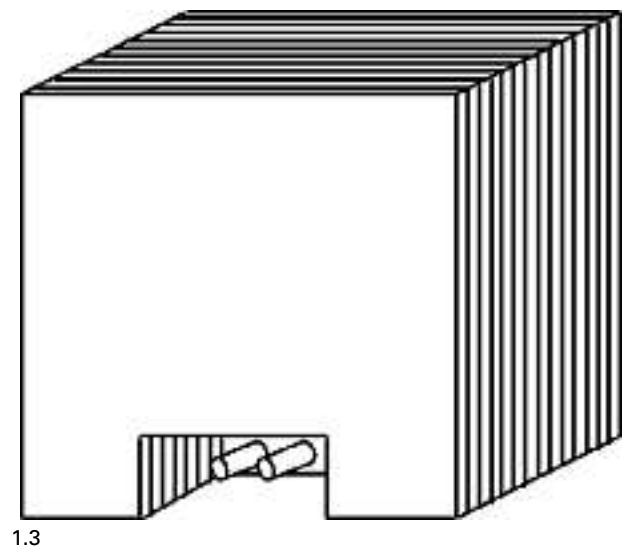

1.3

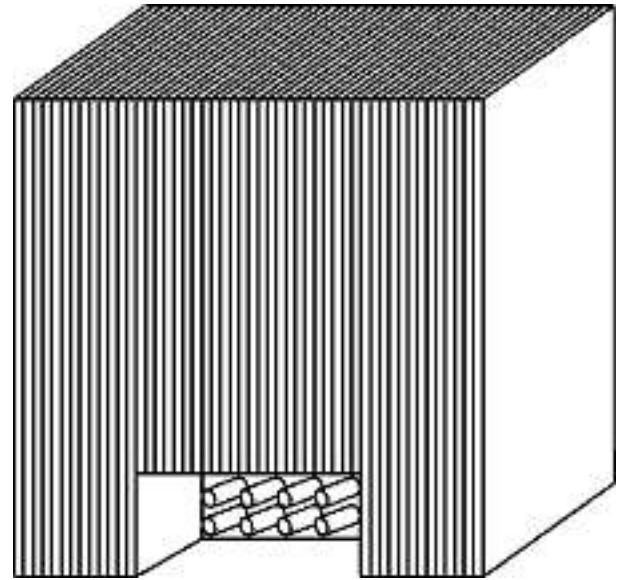
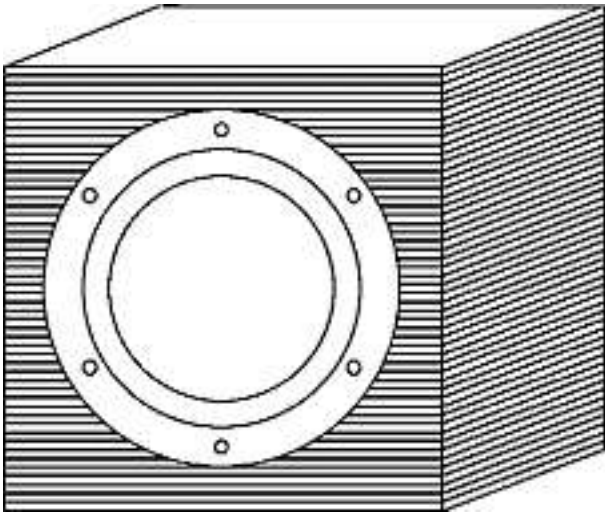

2.2

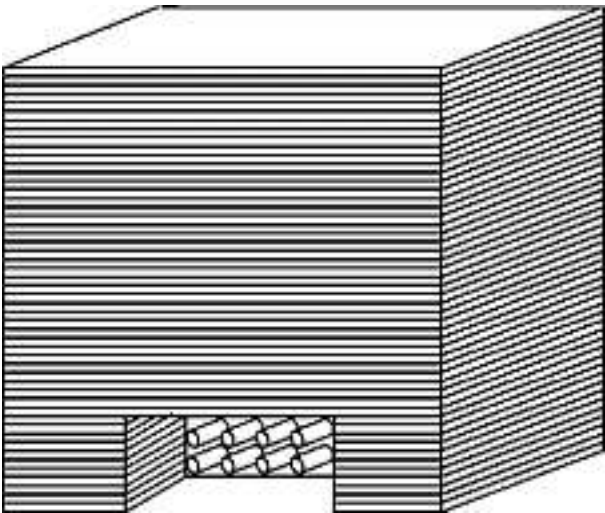

2.1

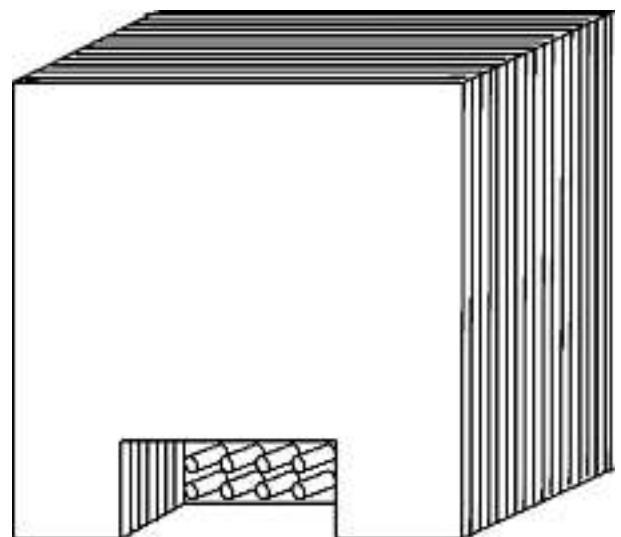
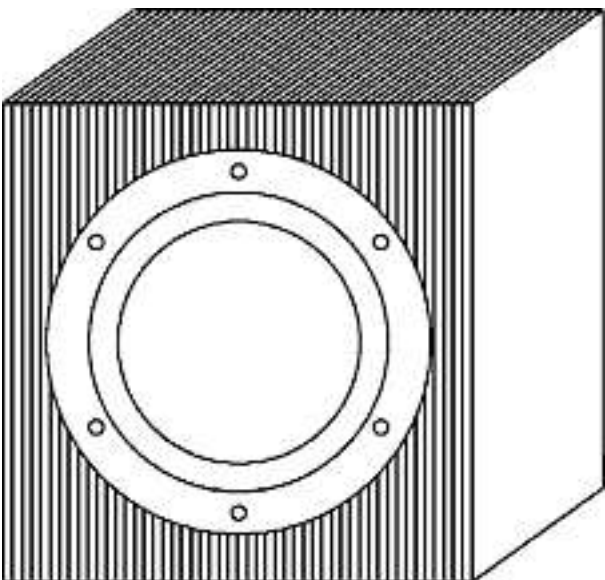
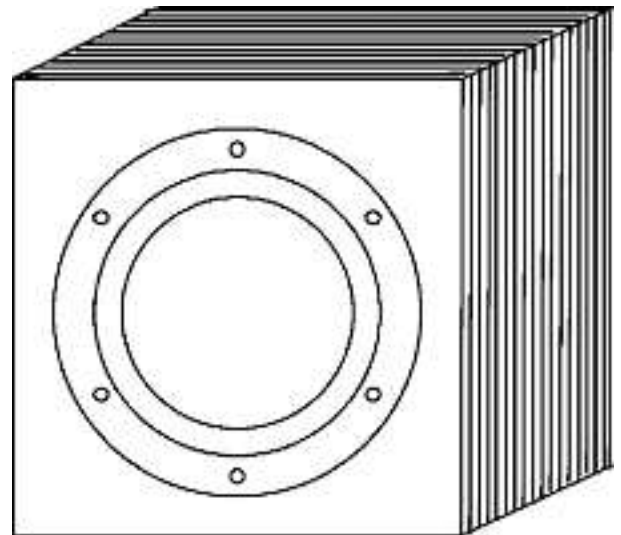

2.3

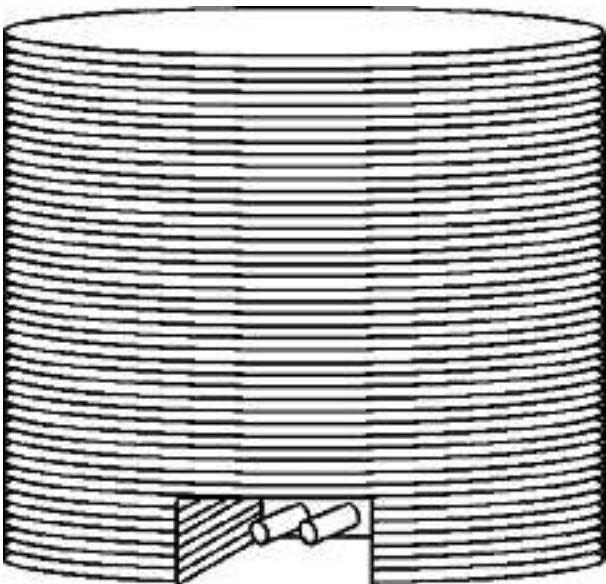
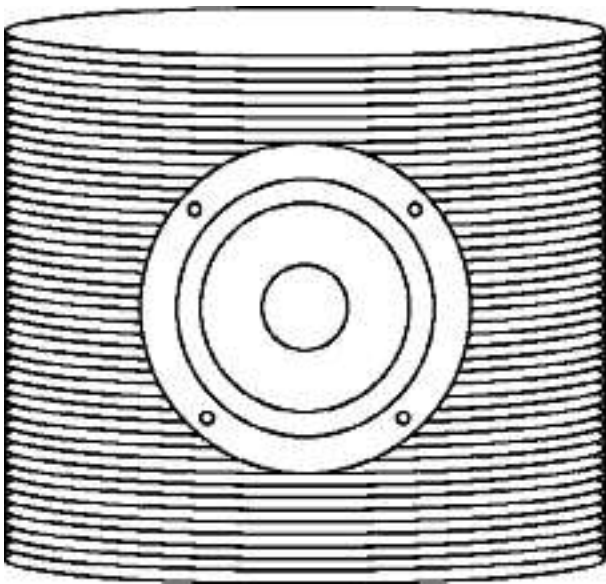

3

Cl. 14-04 133 918 05.04.2007
 1 Design – Bildschirmoberfläche
 Hinterleger: Daniel Trumpf, Weihergrabenweg 35,
 3612 Steffisburg

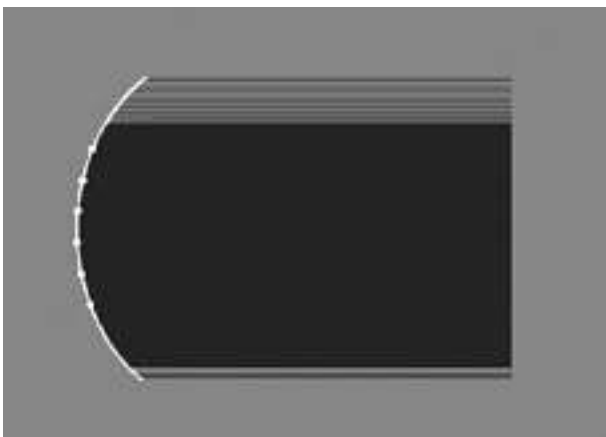

070407

Cl. 15-09 133 919 27.04.2007
 3 design – coupeuse, fendeuse, assembleuse
 Déposant: Para-Helptech Sàrl, Les Apics, 1873 Val d'Illeiez
 Designer: Jean-Philippe Jaton, Val d'Illeiez

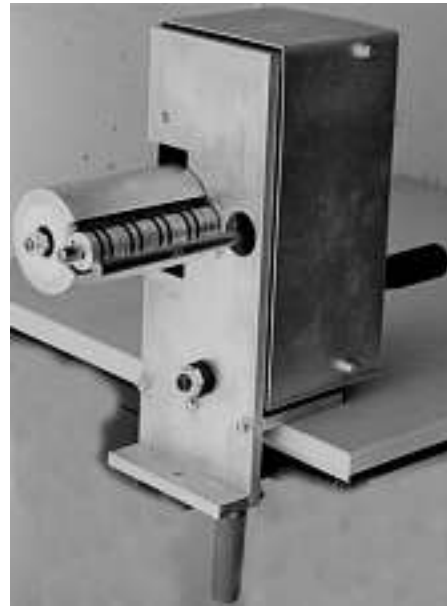

K1

Description du design: K1 est un appareil à couper des tubes de carton avec un entraînement rotatif de façon à faire des anneaux sans plis aux dimensions bien précises.

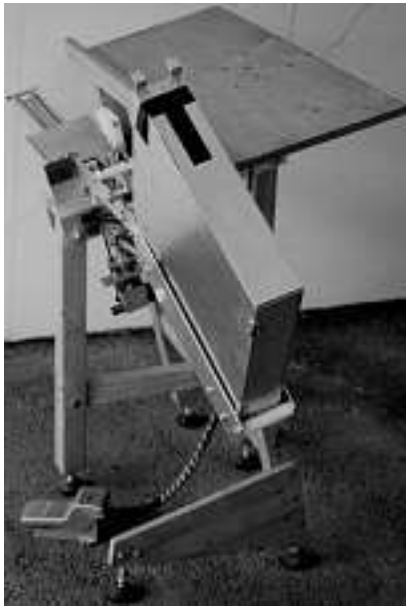

K2

Description du design: K2 est un appareil à fendre le bois en bâtonnets.

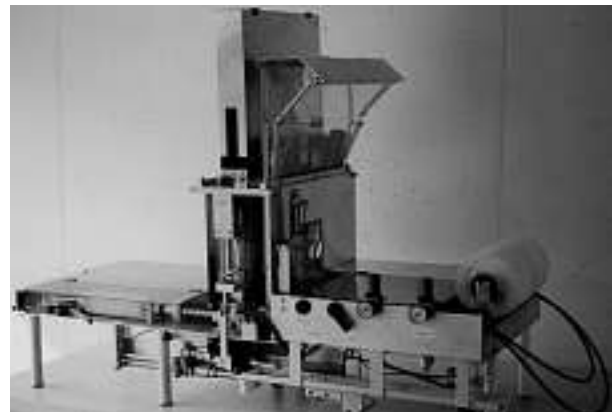
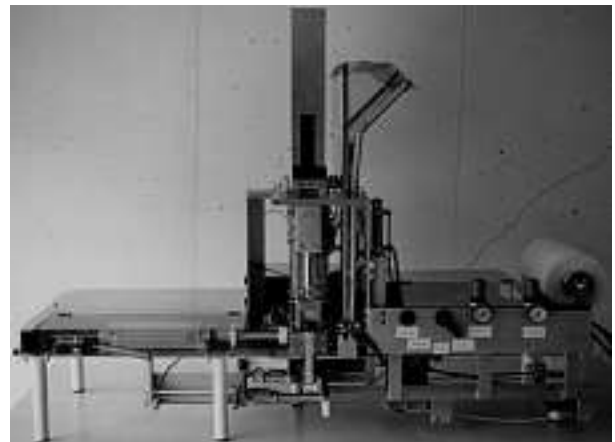
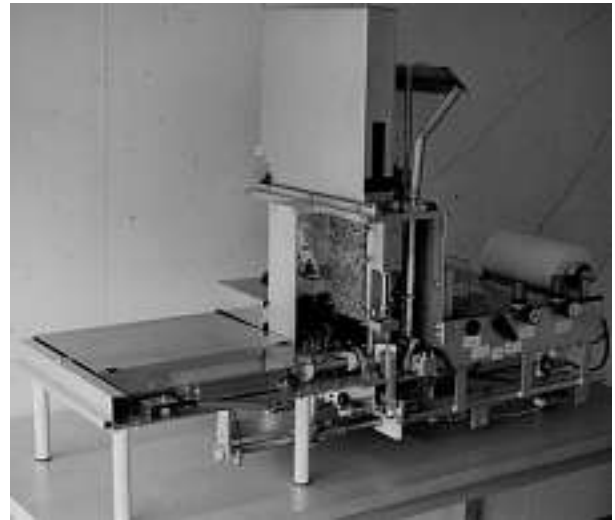

K3

Description du design: K3 est un appareil à assembler les anneaux découpés, les bâtonnets fendus et en plus d'insérer à l'intérieur une mèche de coton.

Cl. 19-06 **133 920** 29.03.2007

3 Design – Schreibgeräte sowie Halter hierfür
 Hinterleger: MACMA Werbeartikel oHG, Thomas-Mann-
 Strasse 60, Nürnberg, DE
 Designer: Matthias Huff, Altdorf; Matthias Vogl, Nürnberg
 Vertreter: Isler & Isler, 6342 Baar

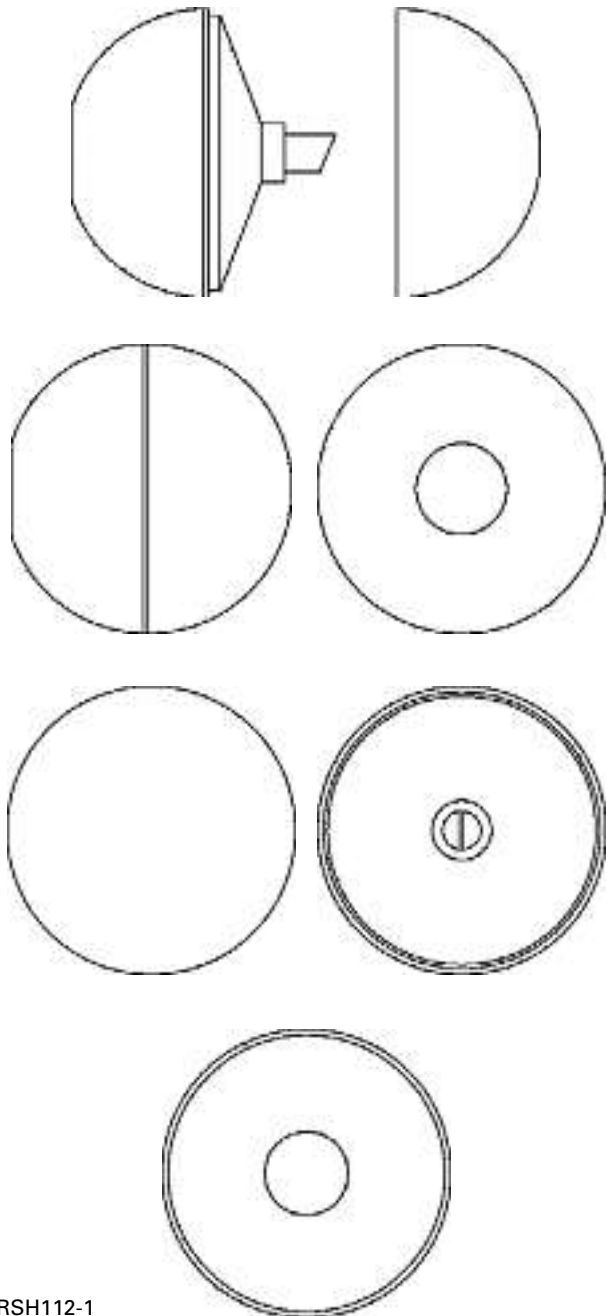

RSH112-1

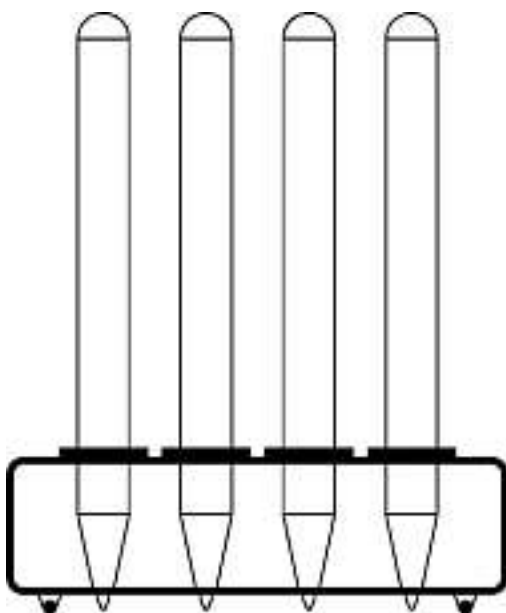

RSH112-2

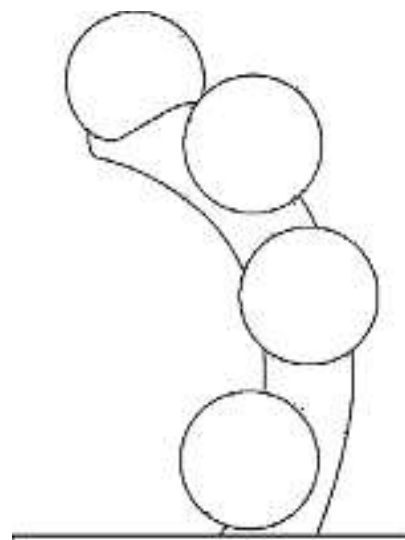
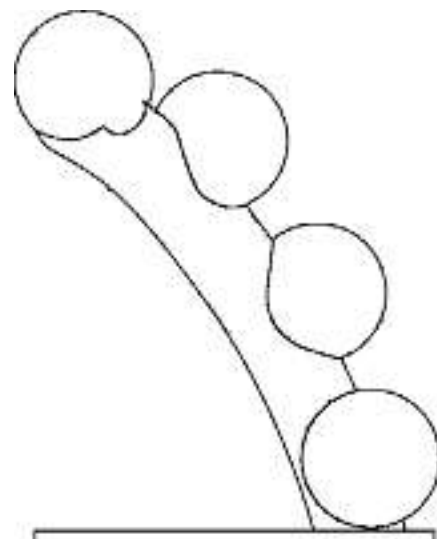
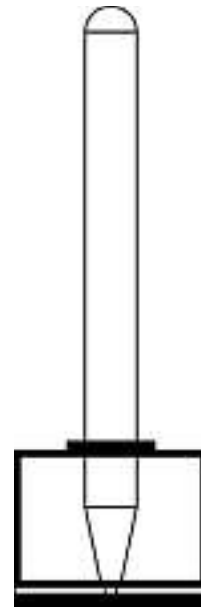

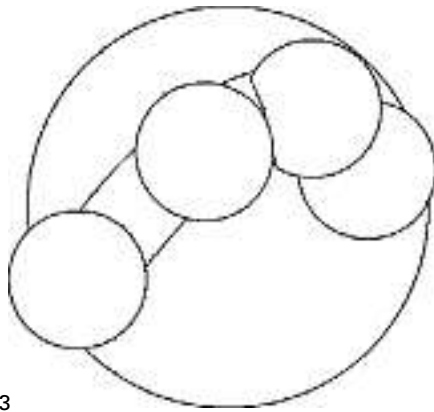

RSH112-3

Cl. 19-08 133 921 24.04.2007
 1 design – imprimé
 Déposant: Daniel Stoecklin, chemin des Planches 10,
 1073 Savigny

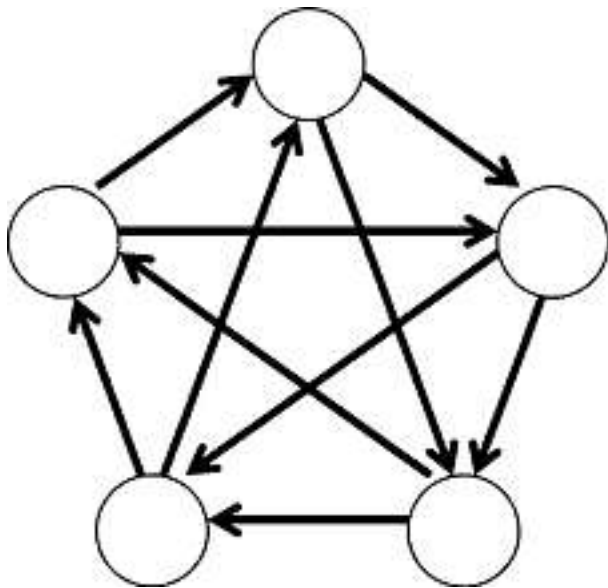

ACTIVE-SELF

Cl. 20-02, 20-03 133 922 29.03.2007
 3 Design – Anzeigergeräte
 Hinterleger: Springboard Retail Networks Inc., Suite 320,
 207 Queen's Quay West, Toronto, Ontario, CA
 Designer: Sylvain Perrier, Newmarket; Jeremy List,
 Newmarket; Russell Harper, Toronto; Jason Busschaert,
 Towson; Sarah Dobbins, Ottawa
 Vertreter: CMS von Erlach Henrici, 8002 Zürich
 Priorität: CA, 26.10.2006

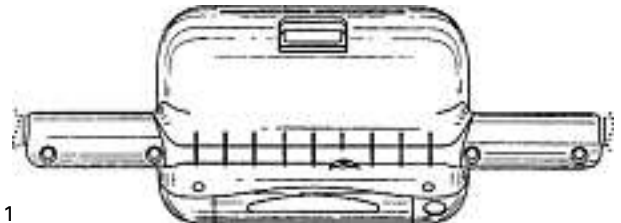
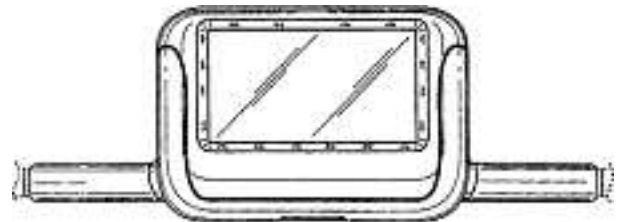
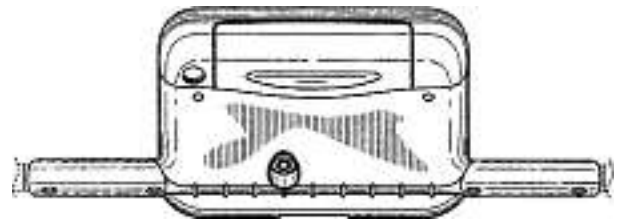
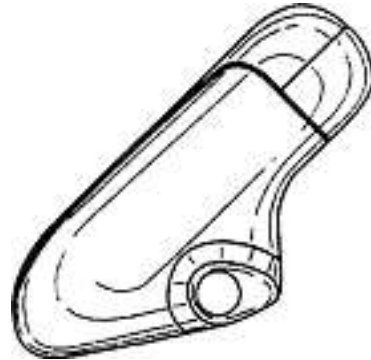
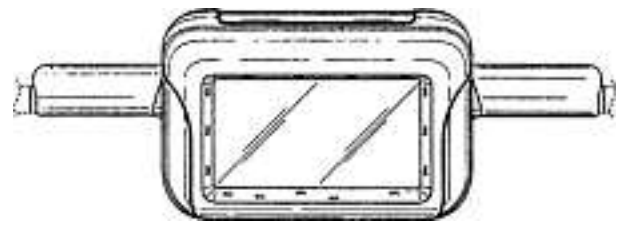
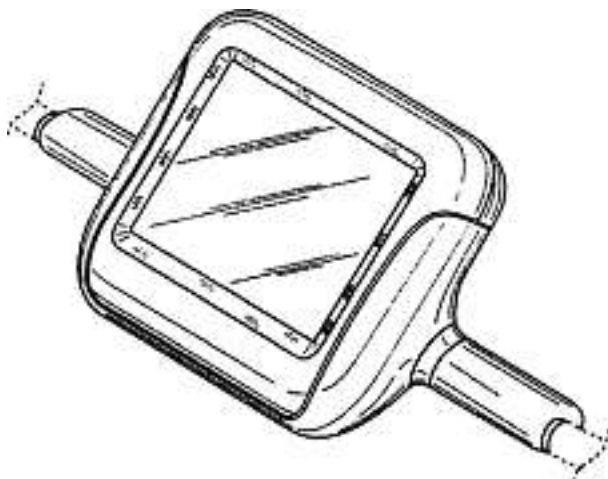

1

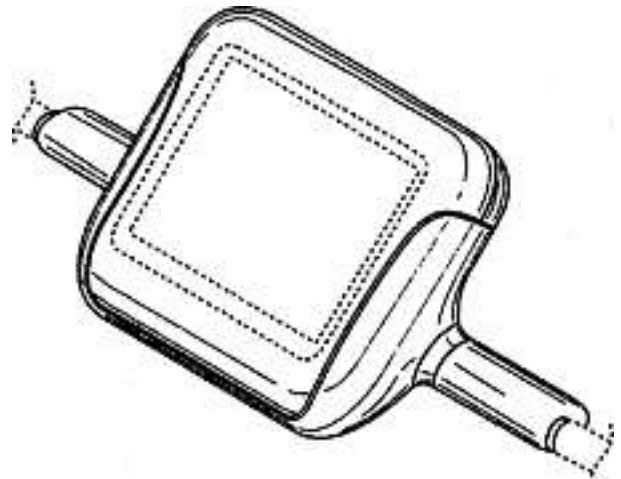

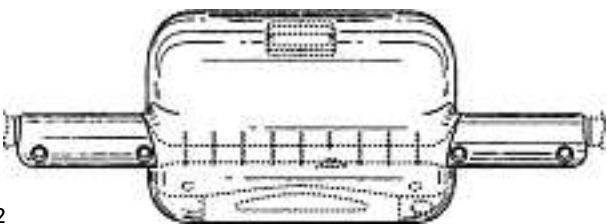
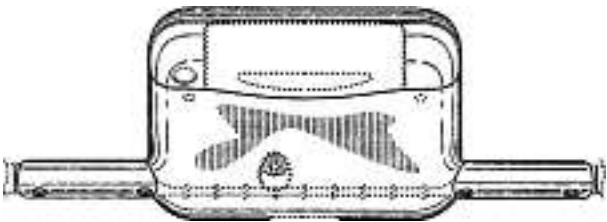
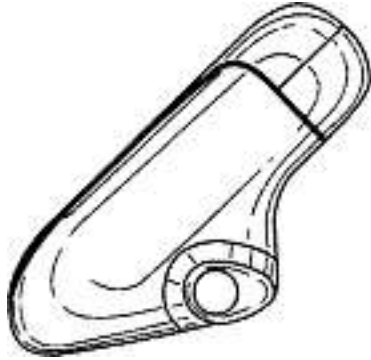
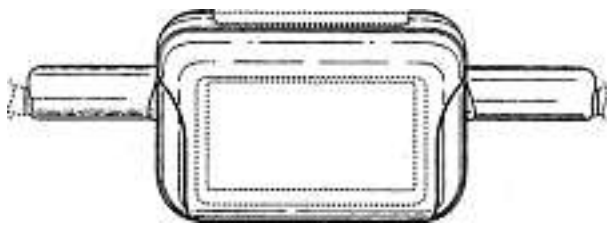

2

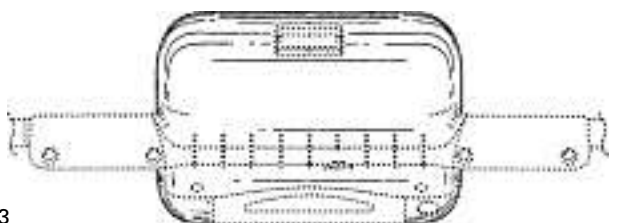
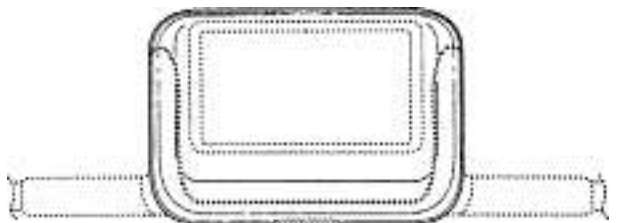
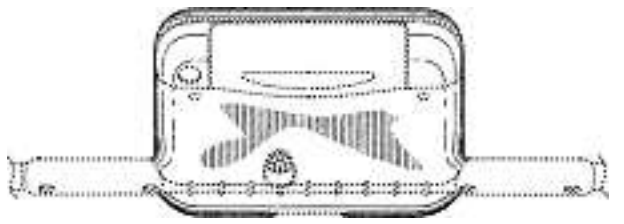
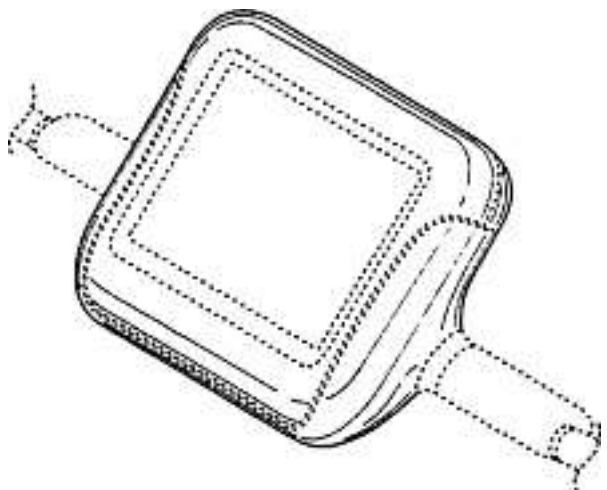

3

Cl. 20-02 **133 923** 13.04.2007
12 Design – Präsentationsständer
Hinterleger: Visplay International AG, Klüfenfeldstrasse 22,
4132 Muttenz
Designer: Karsten K. Krebs, Hannover
Vertreter: AXON Patent GmbH, 4147 Aesch



2



1



3

4



7



5



6



8





9



10



11



12

Cl. 23-02 133 924 19.04.2007
 2 Design - WC
 Hinterleger: Stefan Basig, Reichsgasse 54, 7000 Chur



1



2

Cl. 24-02 **133 925** 11.04.2007
 1 Design – Medizinisches Instrument
 Hinterleger: Astra Tech AB, Aminogatan 1, 431 21 Mölndal, SE
 Designer: Göran Fröjd, Göteborg
 Vertreter: R. A. Egli & Co., Patentanwälte, 8008 Zürich
 Priorität: EM, 07.11.2006

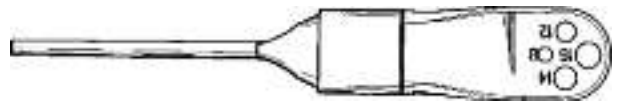
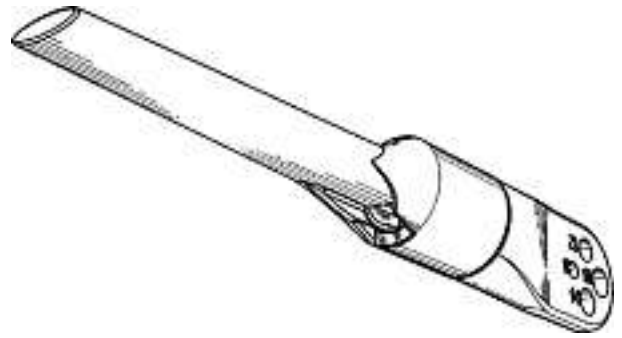
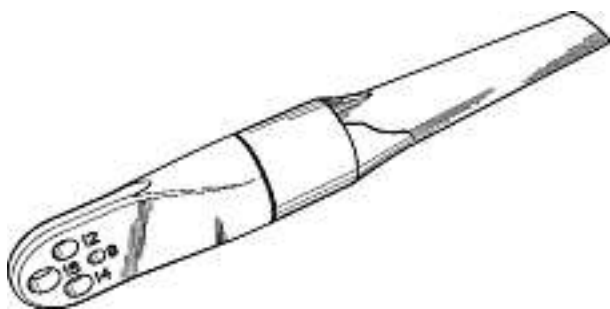

1

Cl. 24-02 **133 926** 20.04.2007
 1 Design – Medizinische Absaugpumpe
 Hinterleger: Medela Holding AG, Lättichstrasse 4b, 6340 Baar
 Designer: Britta Pukall, Männedorf; Ivo Ramella, Ebikon;
 Urs Koch, Greppen; Therese Naef, Baden
 Vertreter: Isler & Pedrazzini AG, 8027 Zürich

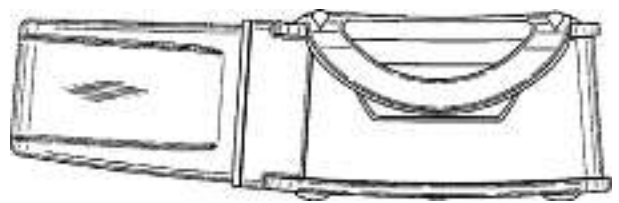
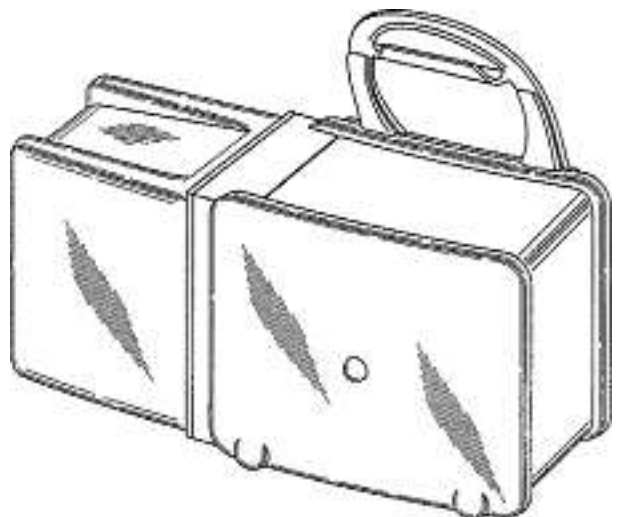

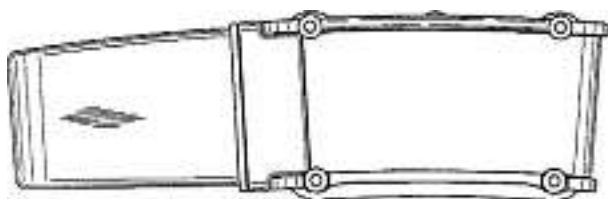
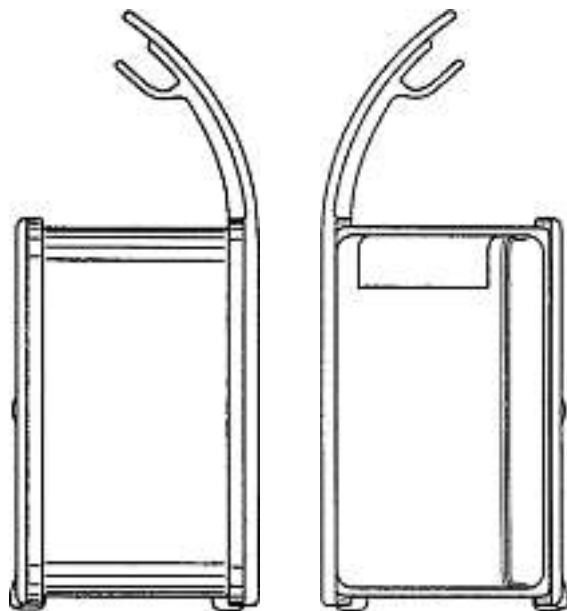
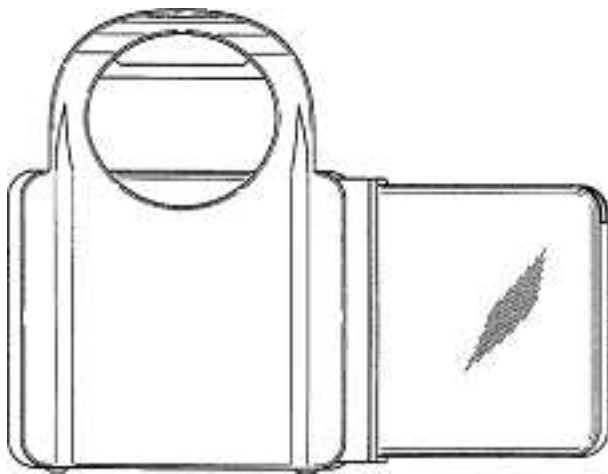
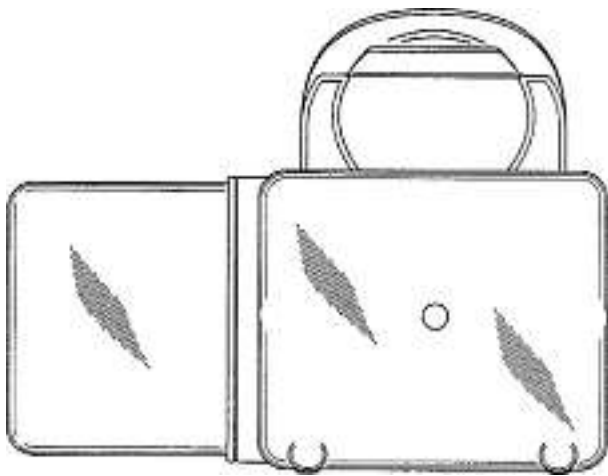

M13332

Cl. 24-04 133 927 13.04.2007
 18 Design – Pflaster
 Hinterleger: Hexal Aktiengesellschaft, Industriestrasse 25,
 83607 Holzkirchen, DE
 Designer: Ralf Kibele, Bruckmühl; Karin Klokkes,
 Feldkirchen-Westerham; Hans-Jürgen Schlüter, Bad Tölz
 Vertreter: E. Blum & Co. AG, Patent- und Markenanwälte VSP,
 8044 Zürich
 Priorität: DE, 20.10.2006

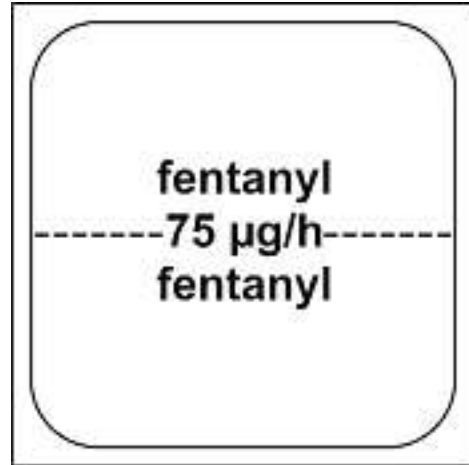

A-2007/1015a

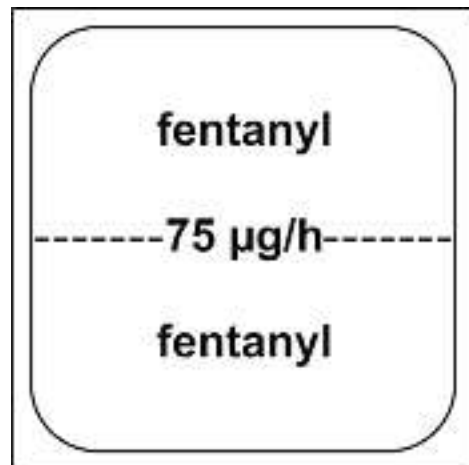

A-2007/1015b

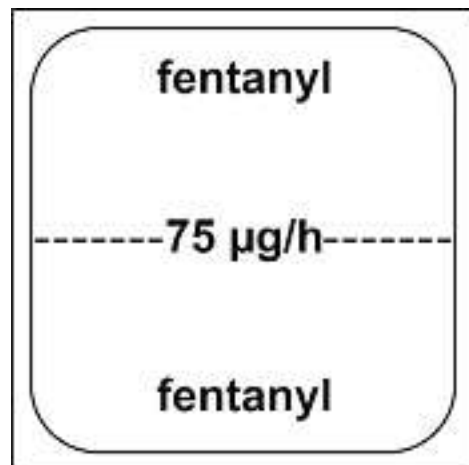

A-2007/1015c

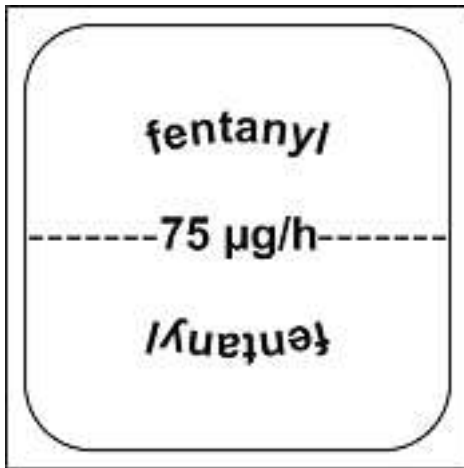

A-2007/1015d

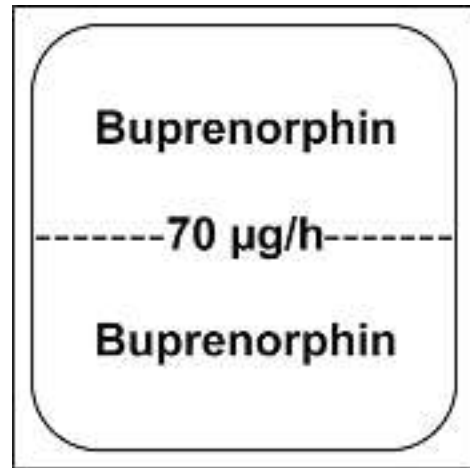

A-2007/1015g

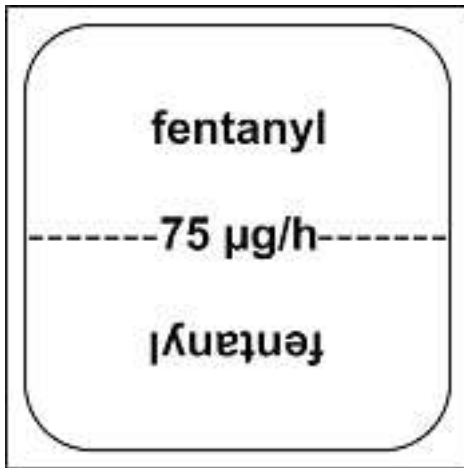

A-2007/1015e

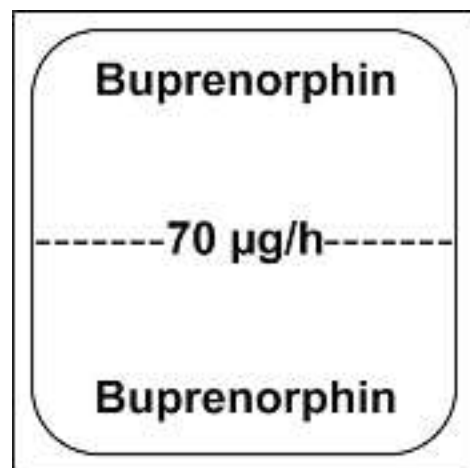

A-2007/1015h

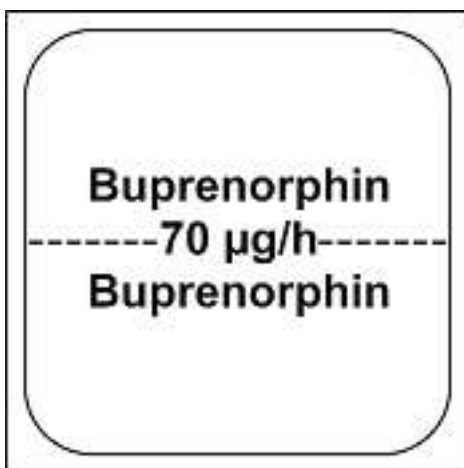

A-2007/1015f

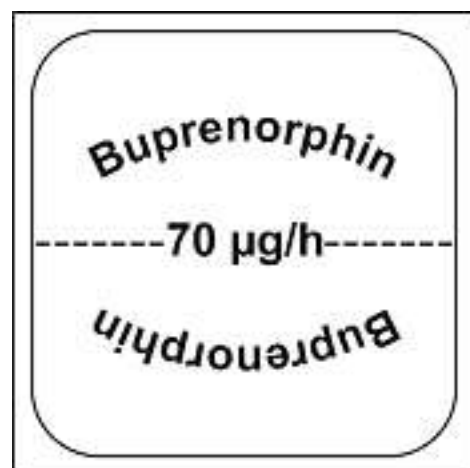

A-2007/1015i

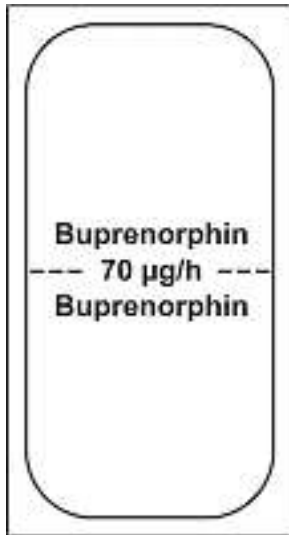

A-2007/1015j

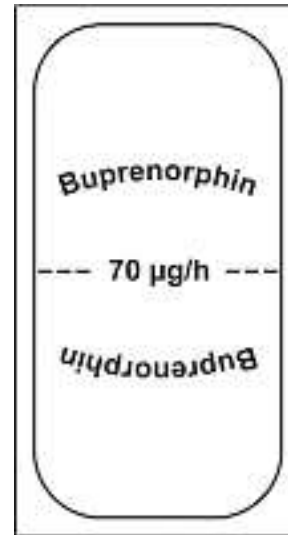

A-2007/1015m

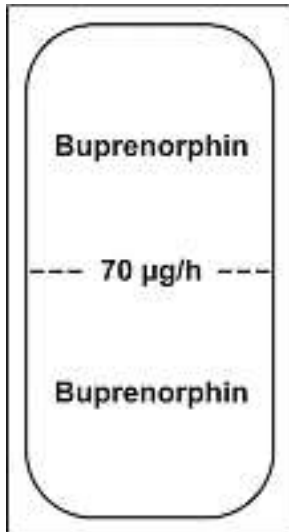

A-2007/1015k

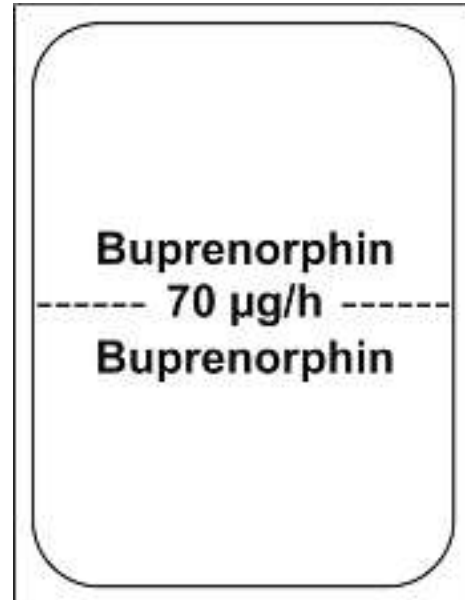

A-2007/1015n

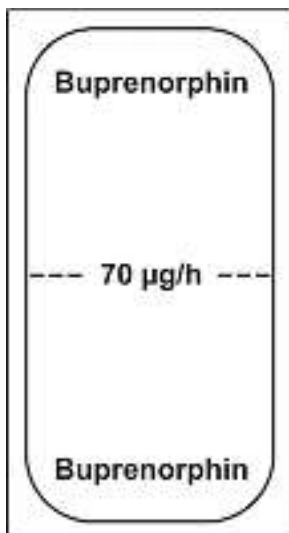

A-2007/1015l

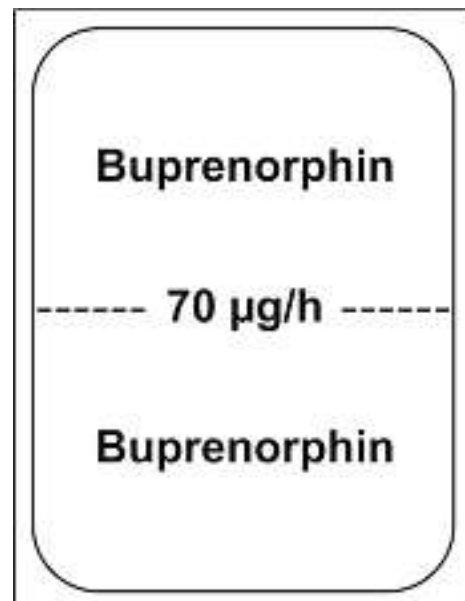

A-2007/1015o

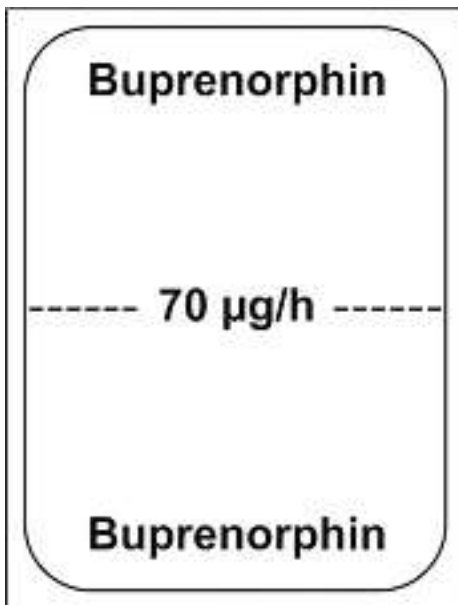

A-2007/1015p

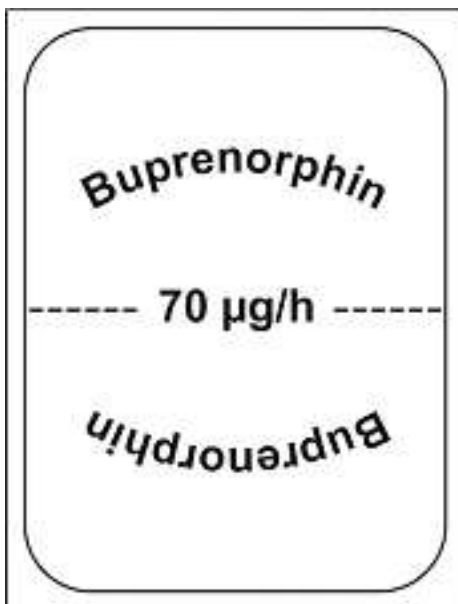

A-2007/1015q

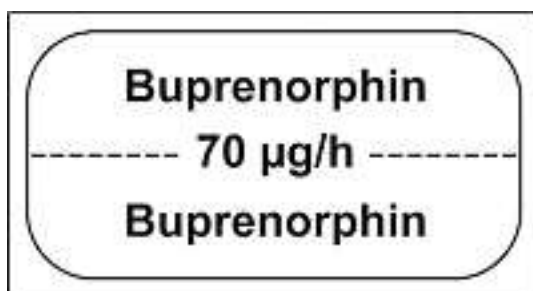

A-2007/1015r

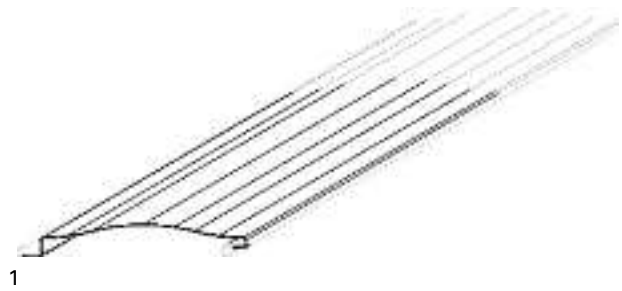

1

Cl. 26-05 133 929 13.04.2007

2 Design – Lampe
 Hinterleger: Ansorg GmbH, Solinger Strasse 19,
 45481 Mülheim an der Ruhr, DE
 Designer: Karsten K. Krebs, Hannover
 Vertreter: AXON Patent GmbH, 4147 Aesch

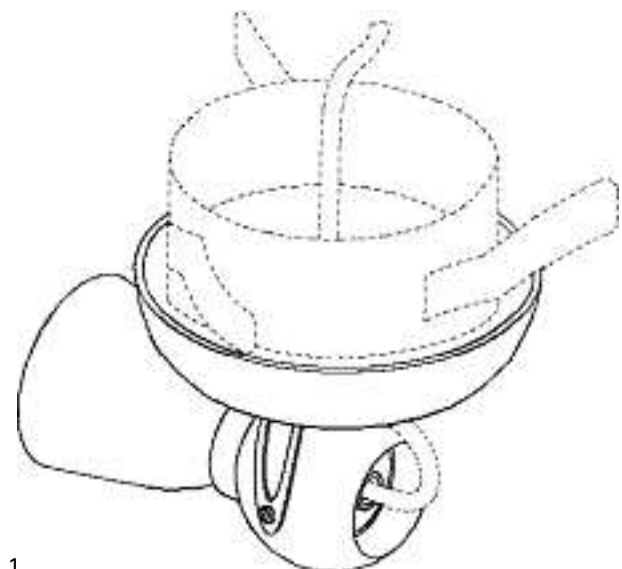
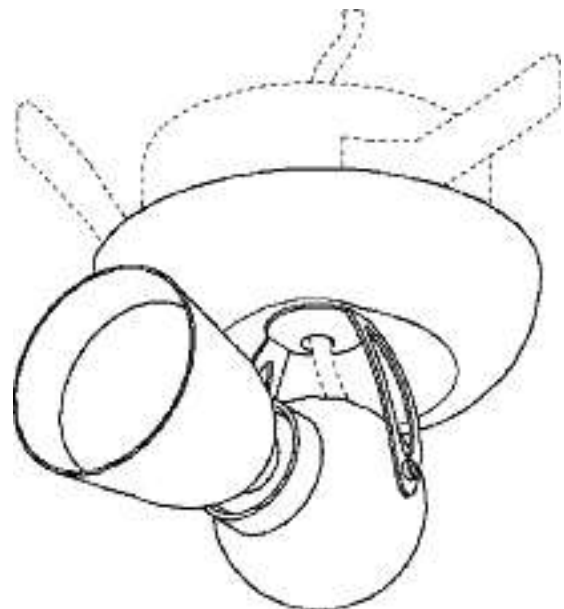

1

Cl. 25-02 133 928 24.04.2007

1 Design – Fassaden Paneel
 Hinterleger: HSW Monteco GmbH, Feldrietstrasse 3,
 9204 Andwil
 Designer: Walter Schneider sen., Andwil
 Vertreter: Riederer Hasler & Partner Patentanwälte AG,
 7310 Bad Ragaz

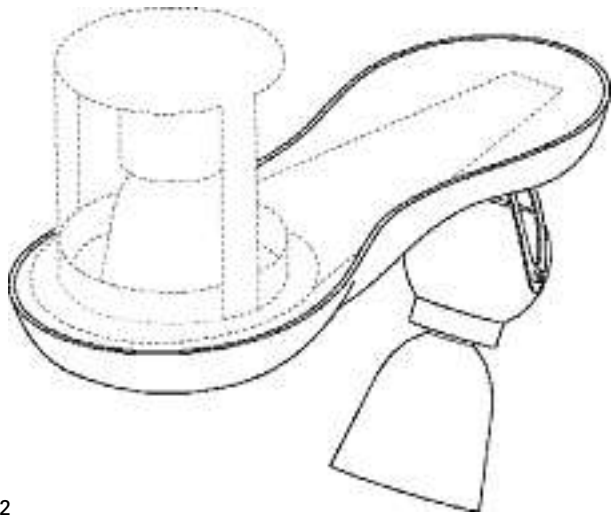
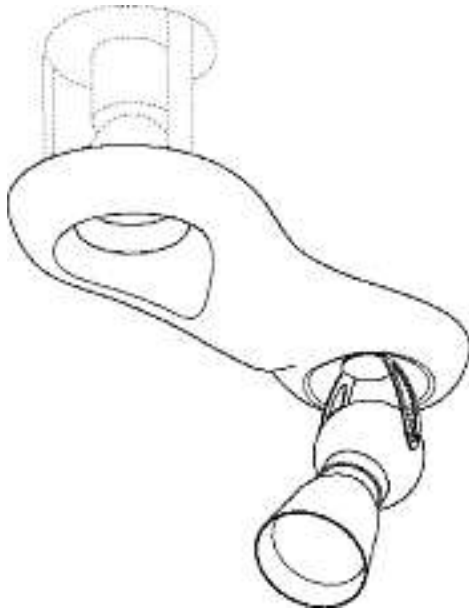

2

Cl. 26-05 133 930 18.04.2007
4 Design - Lampe
Hinterleger: Belux AG, Klünenfeldstrasse 20, 4132 Muttenz
Designer: Hella Jongerius, Rotterdam
Vertreter: AXON Patent GmbH, 4147 Aesch

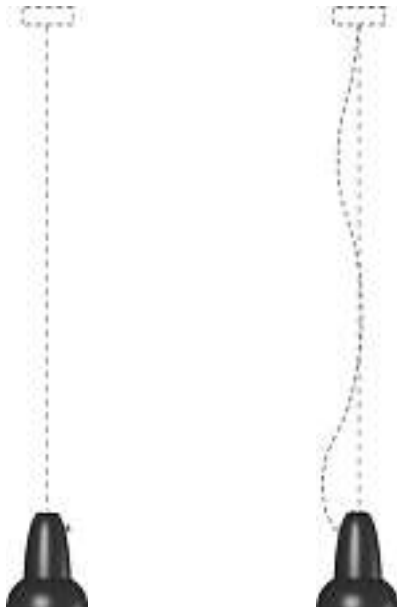

1



2





4



Cl. 31-00 **133 931** 02.04.2007
1 Design – Präsentationskäserei
Hinterleger: Niklaus Stadelmann, Riet 85, 9658 Wildhaus

3

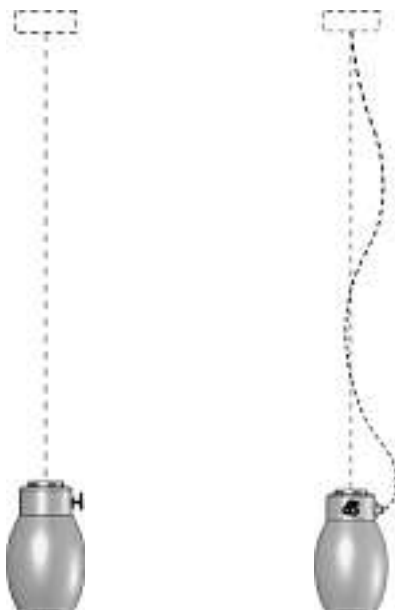

Miniaturkäserei

**Verlängerungen
Prolongations
Prolongazioni**

116 024	Cl.	11-01	2 design
124 250	Cl.	07-04	1 Design
124 251	Cl.	08-08	1 Design
124 304	Cl.	20-02	1 Design
128 755	Cl.	07-04	1 Design
128 795	Cl.	09-08	1 Design
128 799	Cl.	12-02	1 Design
128 837	Cl.	11-01	2 Design
128 841	Cl.	12-15	1 design
128 851	Cl.	24-04	94 design
128 899	Cl.	08-99	1 Design
128 981	Cl.	09-03	3 Design
129 101	Cl.	08-06	1 Design
129 150	Cl.	11-02	1 Design
129 196	Cl.	07-05	1 Design

**Mutationen
Modifications
Modificazioni**

128 851

Nouveau mandataire
Mandataire:
TRADAMARCA, George W. Humphrey,
1001 Lausanne

129 275

Übertragung
Hinterleger:
CH-Medical GmbH, Postfach 228, 6645 Brione sopra Minusio

132 251

132 532

133 041

133 042

133 043

133 044

Neuer Vertreter
Vertreter:
Troesch Scheidegger Werner AG, Patent- und
Markenanwälte, 8126 Zumikon

**Löschungen
Radiations
Radiazioni**

119 309	Cl.	02-03	2 Design
119 312	Cl.	06-03	2 design
119 372	Cl.	14-03	4 Design
123 703	Cl.	11-02	1 Design
123 723	Cl.	25-01	6 design
123 726	Cl.	01-01	13 design
123 748	Cl.	11-01	63 design
123 749	Cl.	11-01	38 design
123 752	Cl.	13-99	1 Design
123 762	Cl.	21-01	1 design
123 802	Cl.	26-05	3 Design
123 806	Cl.	06-01	1 Design
128 339	Cl.	06-01	2 Design
128 342	Cl.	06-03	1 Design
128 343	Cl.	06-06	1 Design
128 347	Cl.	07-02	1 Design
128 363	Cl.	18-99	1 Design
128 371	Cl.	26-04	1 Design
128 377	Cl.	02-07	1 Design
128 378	Cl.	03-01	18 design
128 382	Cl.	06-01	4 Design
128 383	Cl.	06-01	1 Design
128 384	Cl.	06-04	1 Design
128 390	Cl.	10-02	1 design
128 393	Cl.	10-07	1 design
128 394	Cl.	10-07	1 design
128 395	Cl.	11-01	18 design
128 398	Cl.	14-03	2 design
128 401	Cl.	21-01	1 Design
128 402	Cl.	02-05	2 Design
128 418	Cl.	10-07	1 Design
128 437	Cl.	10-07	1 Design
128 490	Cl.	06-03	1 Design