

Nationale Hinterlegungen

In der folgenden Liste werden die beim Eidgenössischen Institut für Geistiges Eigentum hinterlegten Designs publiziert. Dabei sind der Reihe nach angegeben:

- internationale Klassenangaben
- Hinterlegungsnummer
- Hinterlegungsdatum
- Allenfalls Aufschub der Veröffentlichung
- Anzahl der hinterlegten Designs
- Bezeichnung
- Name und Wohnsitz des Hinterlegers oder der Hinterlegerin
- gegebenenfalls Name und Wohnsitz des Designers oder der Designerin
- Name und Geschäftssitz des allfälligen Vertreters oder der Vertreterin
- gegebenenfalls Prioritätsangaben
- gegebenenfalls Beschreibungstext
- Ordnungsnummer
- Reproduktion des Designs

Internationale Hinterlegungen

Die bei der Weltorganisation für geistiges Eigentum in Genf hinterlegten Muster und Modelle mit Benennung Schweiz geniessen den gleichen Schutz wie national hinterlegte Designs. Sie werden jeweils im Blatt «Bulletin des dessins et modèles internationaux» veröffentlicht. Dieses Publikationsorgan ist deshalb für eine vollständige Recherche unbedingt beizuziehen.

Topographien

Angaben über die vom Eidgenössischen Institut für Geistiges Eigentum eingetragenen Topographien von Halbleitererzeugnissen werden in folgender Anordnung aufgeführt:

- Eintragsnummer
- Anmeldedatum
- Bezeichnung
- Name und Wohnsitz des Anmelders oder der Anmelderin
- gegebenenfalls Name und Wohnsitz des Herstellers oder der Herstellerin
- Name und Geschäftssitz des oder der allfälligen Bevollmächtigten
- Datum und Ort einer allfälligen ersten geschäftlichen Verbreitung der Topographie

Dépôts nationaux

Les designs déposés à l'Institut Fédéral de la Propriété Intellectuelle sont publiés dans la liste qui suit. Les indications y relatives sont mentionnées dans cet ordre:

- indications des classes internationales
- numéro de dépôt
- date de dépôt
- le cas échéant, ajournement de la publication
- nombre des designs déposés
- désignation
- nom et domicile du/de la déposant/e
- le cas échéant, nom et domicile du/de la designer
- nom et domicile de l'éventuel/le mandataire
- le cas échéant, indication de priorité
- le cas échéant, description du design
- numéro attribué à chaque design
- reproduction du design

Dépôts internationaux

Les dessins et modèles déposés à l'Organisation Mondiale de la Propriété Intellectuelle à Genève qui désignent la Suisse jouissent de la même protection que les dépôts nationaux. Ils sont chaque fois publiés dans la feuille «Bulletin des dessins et modèles internationaux». Pour une recherche complète, il est indispensable de consulter ledit organe de publication.

Topographies

Les indications concernant les topographies des produits semi-conducteurs, enregistrées par l'Institut Fédéral de la Propriété Intellectuelle, sont énumérées dans l'ordre suivant:

- numéro d'enregistrement
- date de dépôt
- désignation
- nom et domicile du/de la déposant/e
- le cas échéant, nom et domicile du/de la producteur/trice
- nom et domicile de l'éventuel/le mandataire
- date et lieu d'une éventuelle première mise en circulation de la topographie

Depositi nazionali

Nella lista seguente vengono pubblicati i design depositati presso l'Istituto Federale della Proprietà Intellettuale. Sono menzionati nel seguente ordine:

- indicazioni delle classi internazionali
- numero di deposito
- data del deposito
- se del caso, indicazione che la pubblicazione è stata differita
- numero dei design depositati
- designazione
- nome e domicilio del depositante
- se del caso, nome e domicilio del designer
- nome e sede di un eventuale mandataro
- se del caso, indicazioni di priorità
- se del caso, descrizione del design
- numero d'ordine
- riproduzione del design

Depositi internazionali

I disegni e modelli depositati presso l'Organizzazione Mondiale della Proprietà Intellettuale a Ginevra con denominazione Svizzera godono della medesima protezione del deposito nazionale. Essi vengono pubblicati ogni volta nel foglio «Bulletin des dessins et modèles internationaux». Quest'organo di pubblicazione è da consultare se si vuole effettuare una ricerca completa.

Topografie

Le indicazioni concernenti le topografie di prodotti a semiconduttori depositati presso l'Istituto Federale della Proprietà Intellettuale sono menzionate nell'ordine seguente:

- numero di registrazione
- data del deposito
- designazione
- nome e domicilio del/la richiedente
- se del caso, nome e domicilio del/la produttore/trice
- nome e sede di un eventuale mandataro
- data e luogo di un'eventuale prima messa in circolazione della topografia

**Hinterlegungen
Dépôts
Deposit**

Cl. 01-01 132 409 16.12.2005
2 design – pâtisseries
Déposant: Fabien Ettori, Chemin de Plonjon 3, 1207 Genève
Mandataire: Griffes Consulting S.A., 1206 Genève



MO-134501-CH

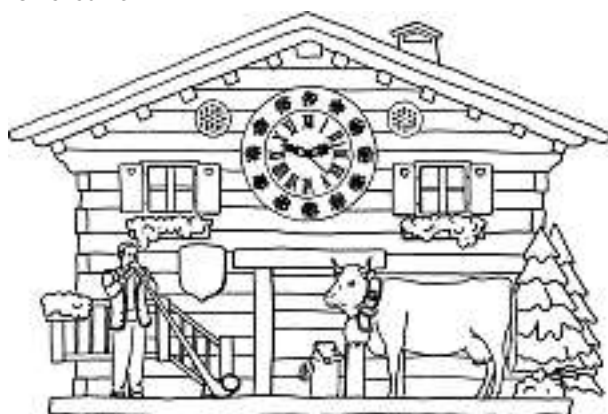

MO-134502-CH

Cl. 02-01 132 410 12.12.2005
6 Design – Damen-Unterwäsche
Hinterleger: NATURANA Dölker GmbH & Co. KG,
Hinterweilerstrasse 3, 72810 Gomaringen, DE
Designer: Eva Dölker-Heim, Gomaringen
Vertreter: Ombretta AG, 6370 Stans
Priorität: EM, 16.11.2005



40 73 99



40 43 99



40 43 97



40 43 98



40 53 99



40 74 99

Cl. 02-03 **132 411** 16.12.2005
1 Design – Kopfbedeckung
Hinterleger: Aziz Yener, Schlosstrasse 42a, Berlin, DE
Vertreter: Cansel Sivritepe, 8424 Embrach
Priorität: EM, 14.12.2005





YEN 001

Cl. 06-03 132 412 05.12.2005
 1 Design – Tisch
 Hinterleger: Markus Wigger, Stägenrain 11, 6244 Nebikon



Cl. 06-04 132 413 21.12.2005
 1 design – meuble audio-vidéo
 Déposant: LEFEVERE NV, Generaal Deprezstraat 2,
 Harelbeke, BE
 Designer: Geert Devolder, Kortrijk
 Mandataire: Katzarov S.A., 1227 Genève
 Priorité: EM, 04.07.2005

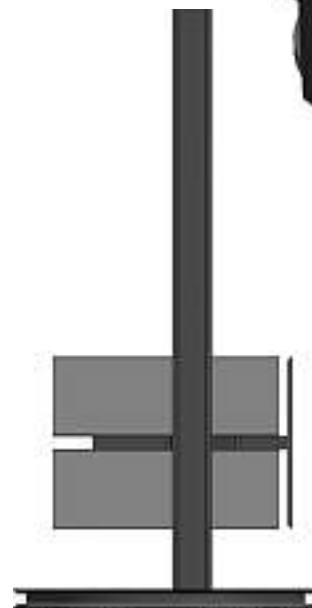
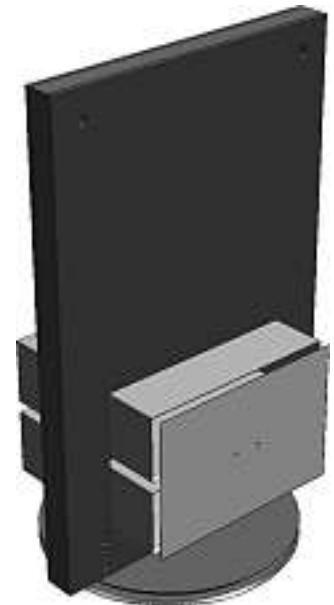

Cl. 06-05 132 414 01.12.2005
1 Design – Arbeitsplatzeinheit
Hinterleger: Os-car Presenting Systems, Michael Schenk,
Parkstrasse 1a, 5012 Schönenwerd
Designer: Michael Schenk, Olten

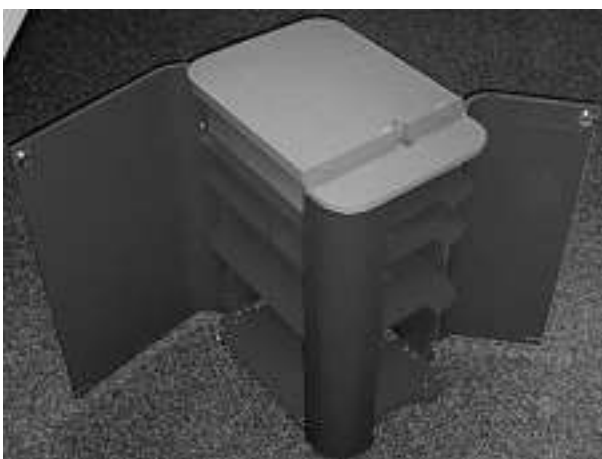



oscar2005



8404



8471



8485

Cl. 07-01 **132 415** 12.12.2005
 5 Design – Bemusterungen für Teller
 Hinterleger: Mila GmbH, Andernacher Strasse 31, Nürnberg, DE
 Designer: Robert Köhler, Nürnberg
 Vertreter: M.I.L.A. Design- und Geschenkartikel GesmbH & Co. KG, Wien (A), Zweigniederlassung Wald, 3086 Englisberg



8493



8494

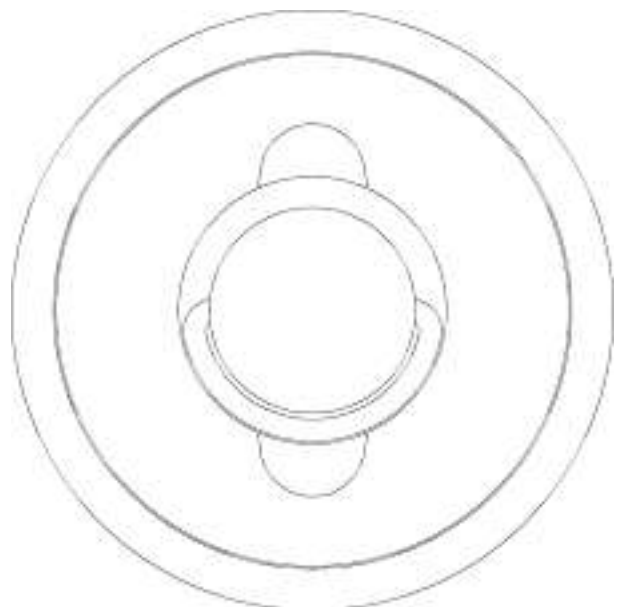
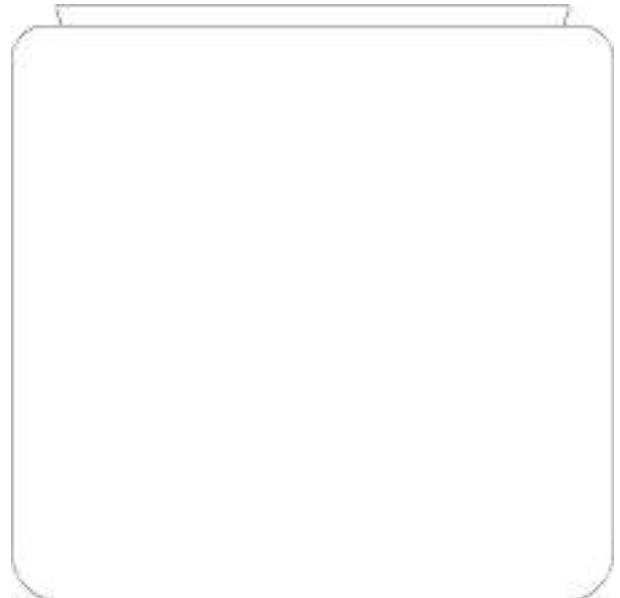

Cl. 07-01 07-03 07-06 **132 416** 20.12.2005
 12 Design – Eiskübel, Eiszange, Salatbesteck, Löffel
 Hinterleger: PI-DESIGN AG, Kantonsstrasse 100,
 6234 Triengen
 Designer: Jorgen Bodum, St. Niklausen
 Vertreter: Isler & Pedrazzini AG, 8023 Zürich
 Priorität: DK, 30.06.2005

M13100-01



M13100-02

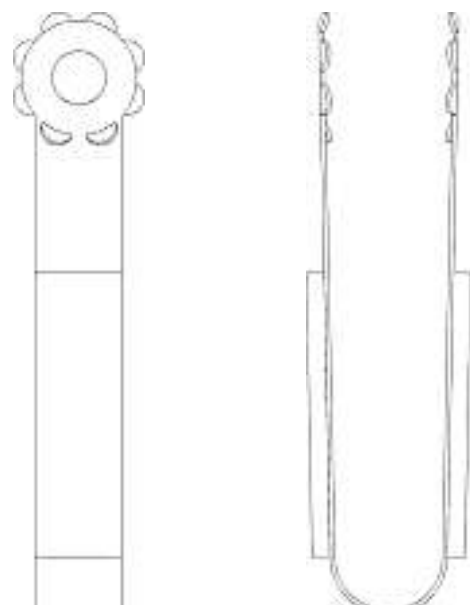
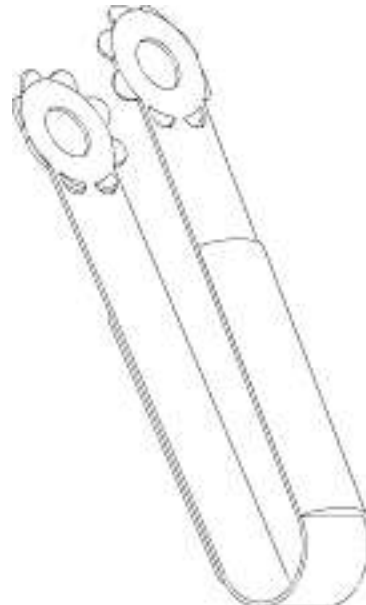

M13100-03



M13100-06

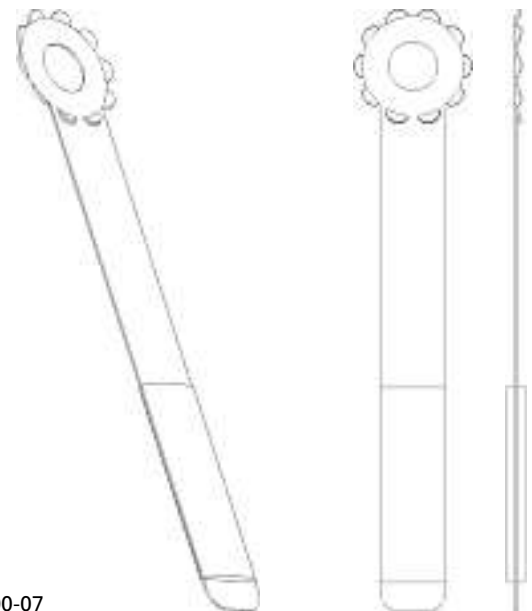

M13100-07

M13100-04

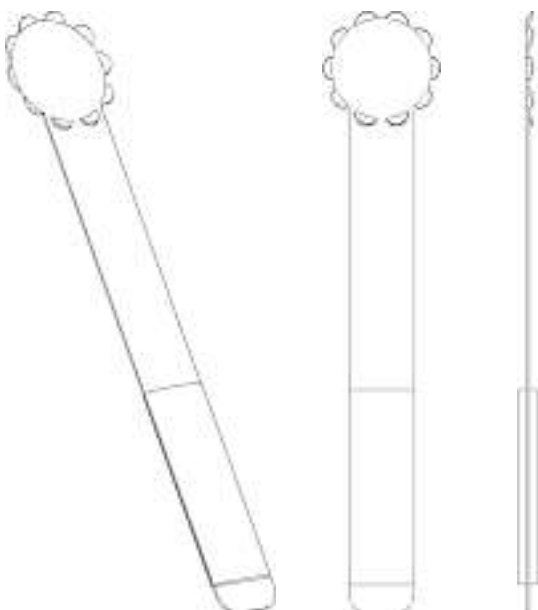

M13100-05



M13100-08

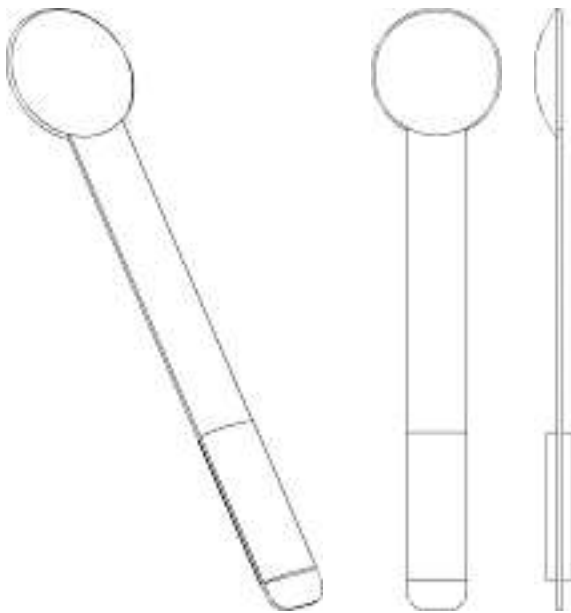

M13100-09

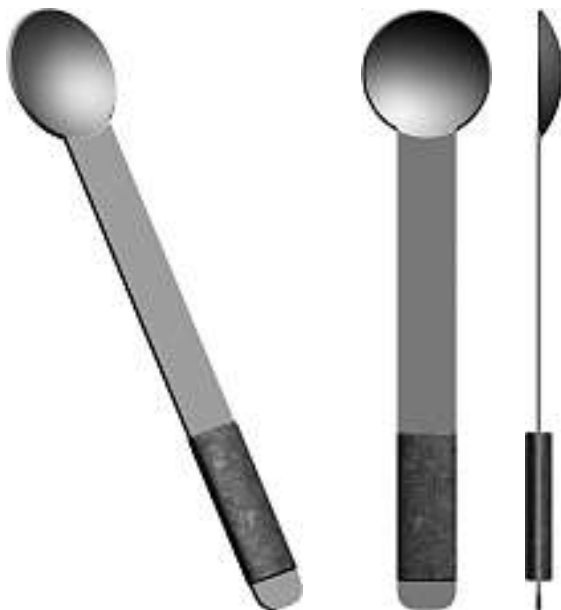

M13100-10

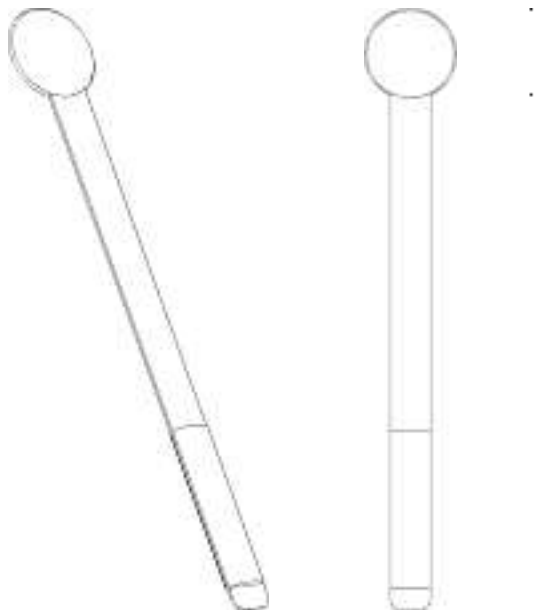

M13100-11



M13100-12

Cl. 07-01 **132 417** 23.12.2005
 4 Design – Dekantiergefäße
 Hinterleger: PI-DESIGN AG, Kantonsstrasse 100,
 6234 Triengen
 Designer: Jorgen Bodum, St. Niklausen
 Vertreter: Isler & Pedrazzini AG, 8023 Zürich
 Priorität: DK, 08.07.2005





M13102-1

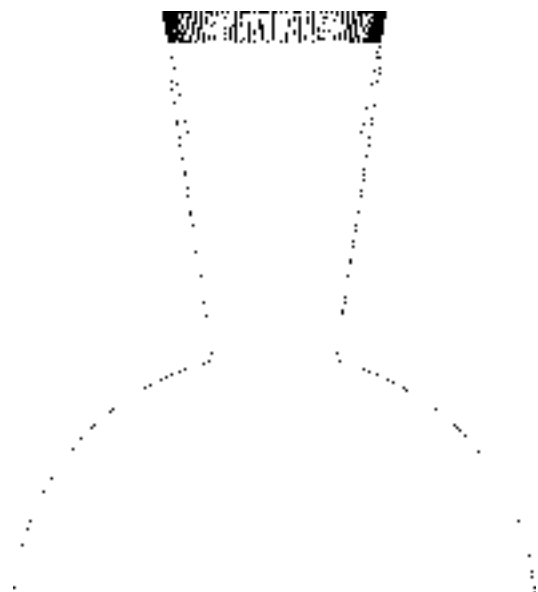

M13102-2



M13102-3

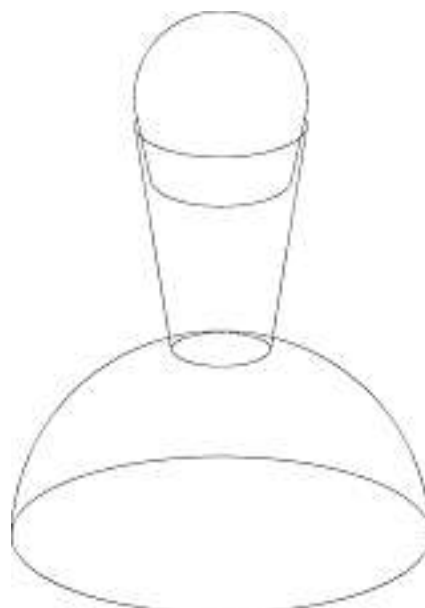

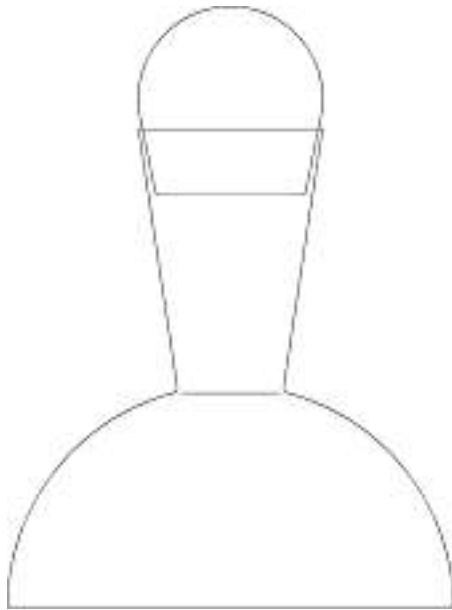

M13102-4

Cl. 07-03 **132 418** 05.12.2005
 5 Design – Besteckset, Besteck
 Hinterleger: Dart Industries Inc., 14901 S. Orange Blossom
 Trail, Orlando / FL, US
 Designer: Jakob Heiberg, Charlottenlund; Dorte
 Sondergaard, Frederiksberg; Douglas M. Laib, Orlando
 Vertreter: A. Braun, Braun, Héritier, Eschmann AG,
 Patentanwälte, 4051 Basel
 Priorität: US, 08.06.2005

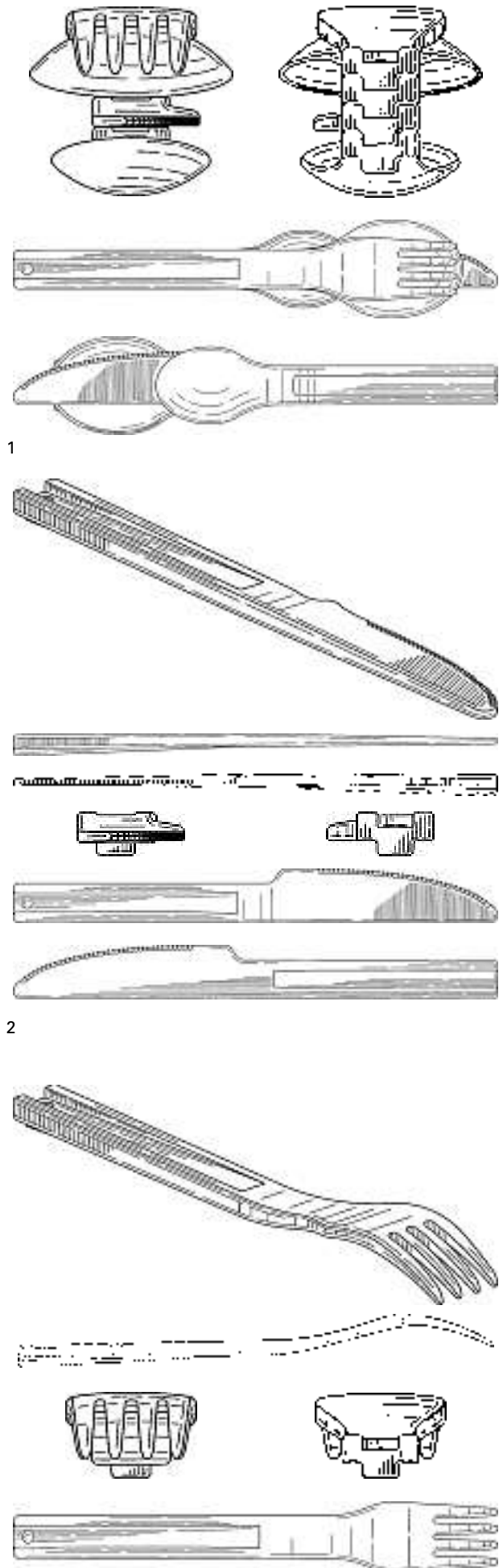
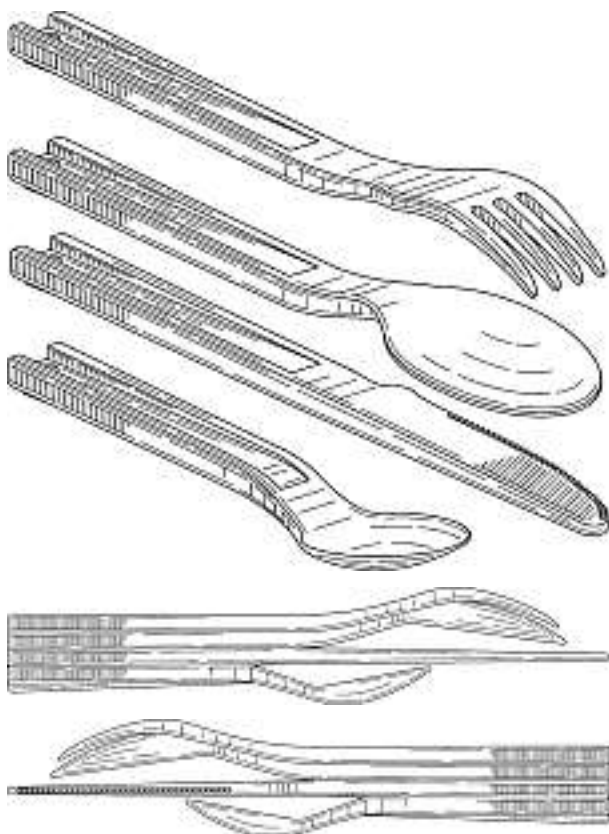



3

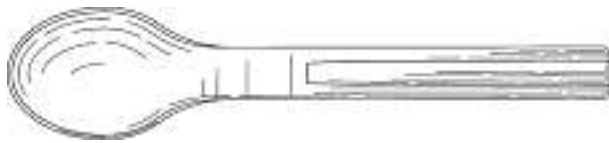
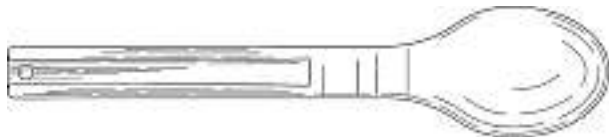
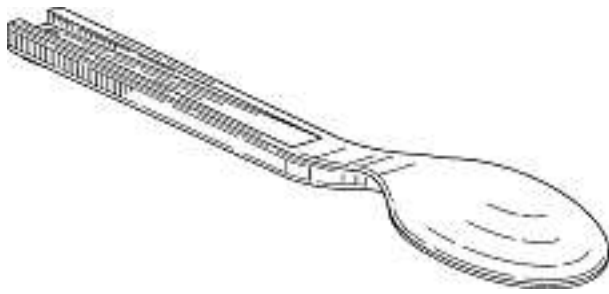

4

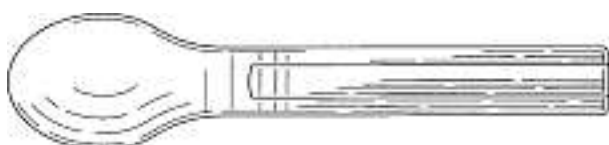
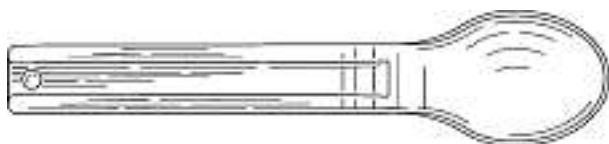
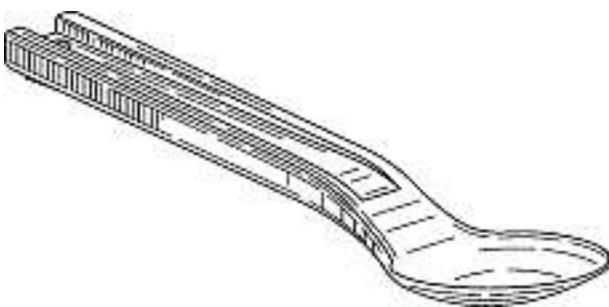

5

Cl. 07-05 132 419 24.11.2005
1 Design – Schwamm
Hinterleger: Livio Altorfer, Dorfstrasse 36, 8454 Buchberg



001

Cl. 08-05 132 420 21.12.2005
 7 Design – Werkzeug
 Hinterleger: Otto Suhner AG, Postfach, 5201 Brugg
 Designer: Peter Dubach, Fislisbach
 Vertreter: Hans Rudolf Gachnang, Patentanwalt,
 8501 Frauenfeld

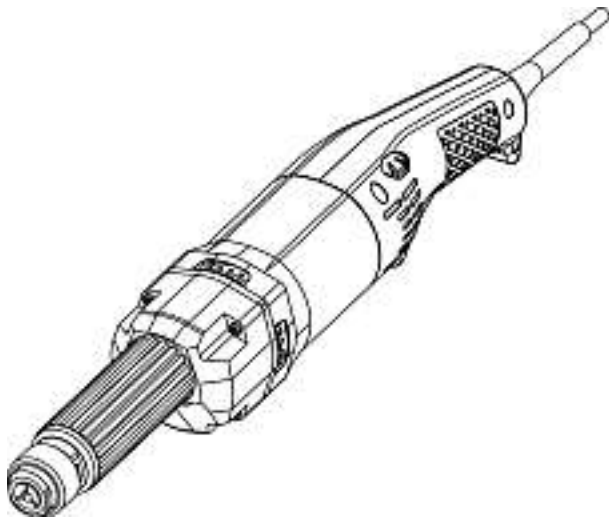

1

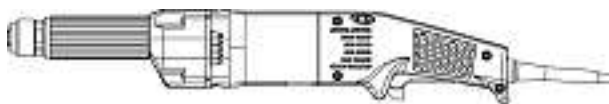

2

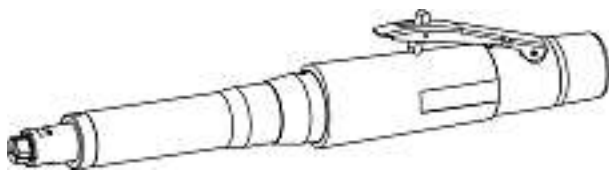

3

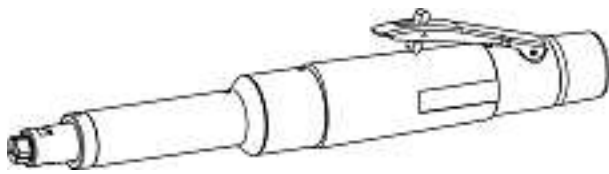

4

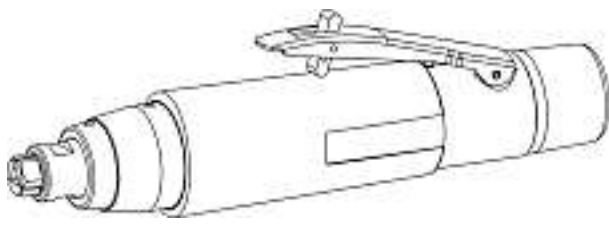

5

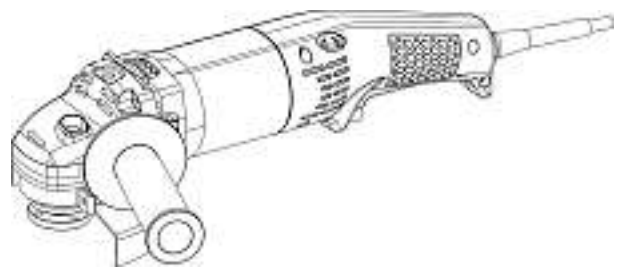
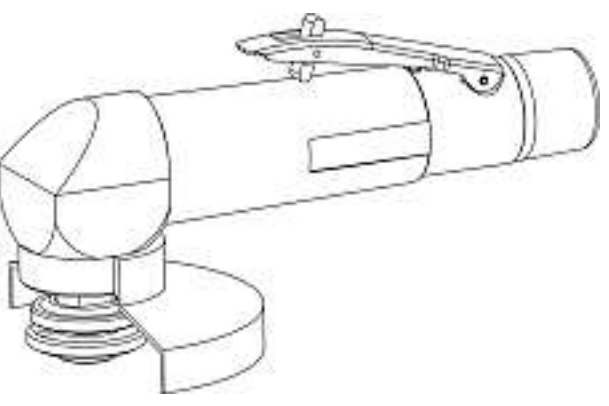

6



7

Cl. 09-01 132 421 22.12.2005
 1 Design – Flasche
 Hinterleger: The Coca-Cola Company, One Coca-Cola
 Plaza N.W., Atlanta, GA, US
 Designer: Kevin Hyde, Tervuren; Chris Forecast, Putney;
 Craig Glass, London; Matt Cotterell, London
 Vertreter: Ritscher & Partner AG, 8702 Zollikon
 Priorität: EM, 11.07.2005



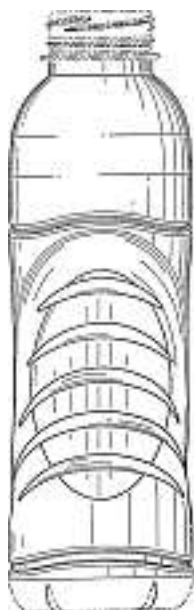
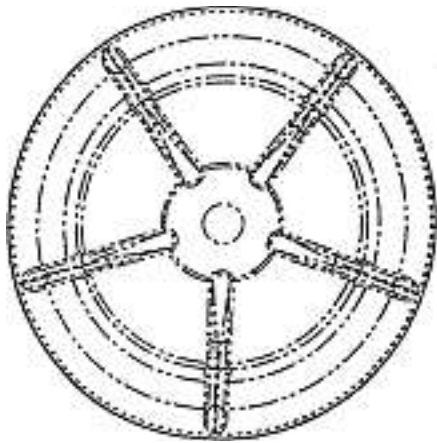
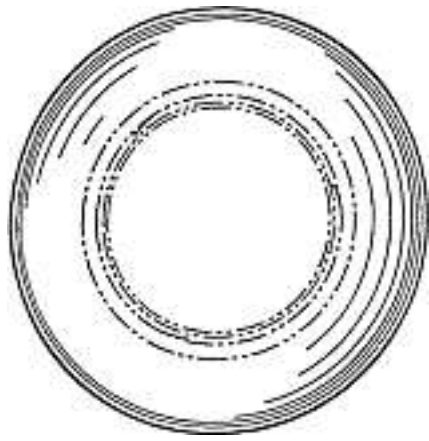

Cl. 09-03 132 422 01.11.2005
 2 Design – Kapselaufnahmebehältnis
 Hinterleger: tavolaswiss GmbH, Büfelderstrasse 1, 8370 Sirnach
 Designer: Stephan Leitl, Ravensburg
 Vertreter: Arie Wubben, 8942 Oberrieden
 Priorität: EM, 10.06.2005
 Beschreibung des Designs: Behältnis zur Aufnahme von mehreren Kapseln. Die vorliegende Designanmeldung betrifft die Idee und Ausgestaltung eines erfindungsgemässen Behältnisses zur Aufnahme von mehreren Kapseln, enthaltend Kaffeepulver, Instantkaffee, Gemisch aus Kaffeepulver, Zucker, Milchpulver und/oder Aromastoffen sowie Tee, Kakao, Cappuchino. Die Designs können in unterschiedlichen Materialien, wie Metall, Edelstahl, Kunststoff oder komposite Werkstoffe, sowie in verschiedenen Farben oder Farbkombinationen hergestellt sein.

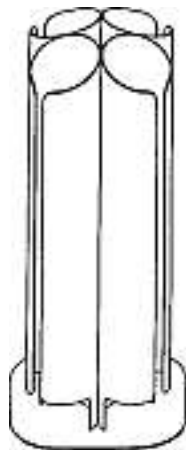
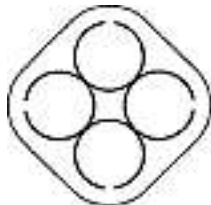
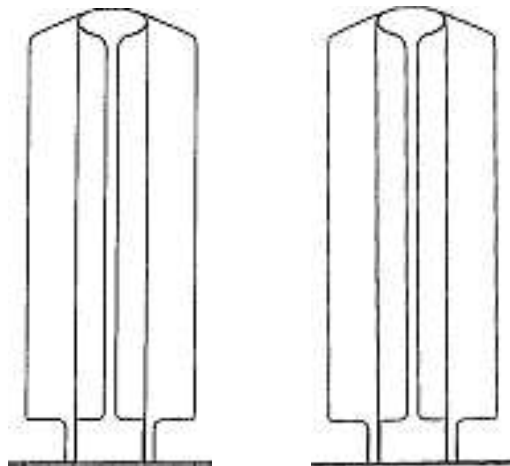

1

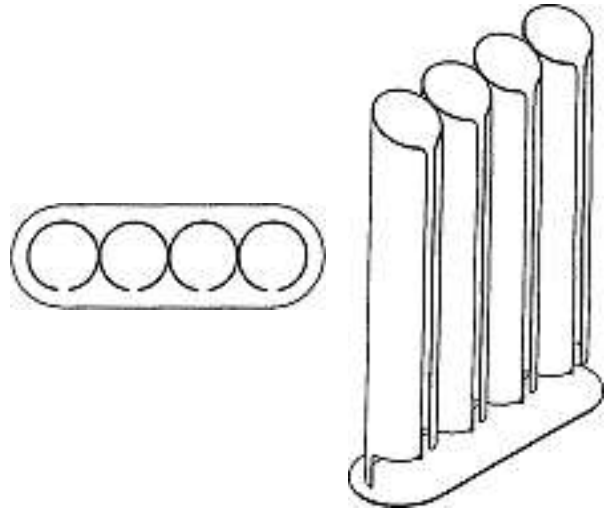
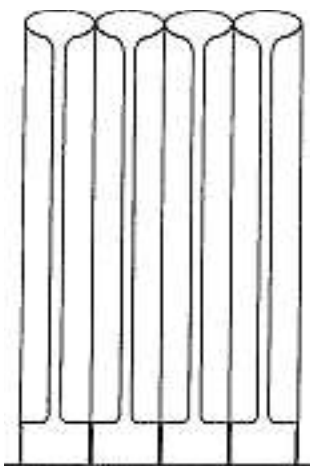

2

Cl. 09-03 132 423 23.11.2005
 1 Design – Verpackung für Tierfutter
 Hinterleger: Stefan Menth, Rebbergstrasse 20a, 5430 Wettingen
 Beschreibung Design «Verpackung für Katzen- und Hundefutter»:
 Das Design beschreibt eine Verpackungsform für Katzen- und Hundefutter, welche gleichzeitig als Essgeschirr dient. Der untere, blau gefärbte Teil enthält eine Portion Futter und besteht aus dünnwandigem, möglichst recycelbarem und formfestem Material (z.B. PET, Alu) und dient als Essgeschirr. Es wird für Transport, Lagerung, Verkauf usw. abgedeckt durch eine Folie, welche mit einer überstehenden Lasche leicht abziehbar ist. Beschriftung und Farbgebung sind hersteller- und markenspezifisch. Das Geschirr ist so gestaltet, dass mehrere solche Verpackungselemente aufeinander gestapelt und zusammen zu grösseren Verkaufseinheiten verpackt werden können (vgl. beispielhafte Schnittzeichnung).

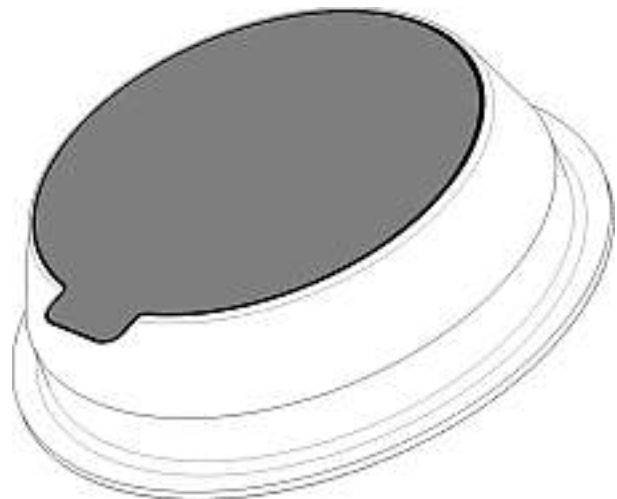

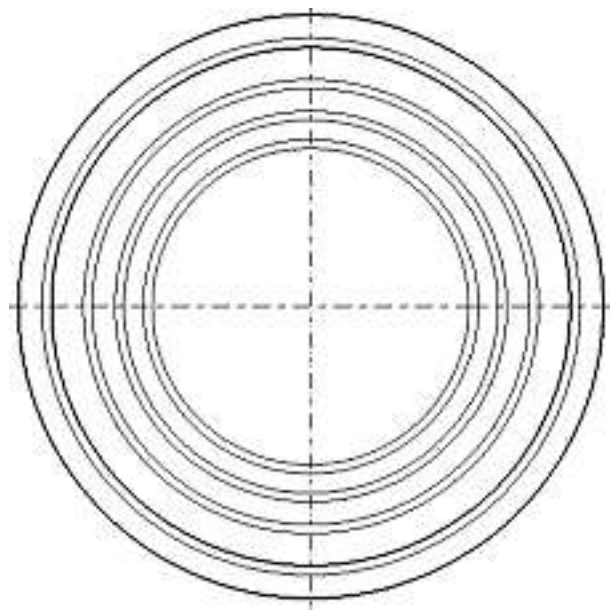
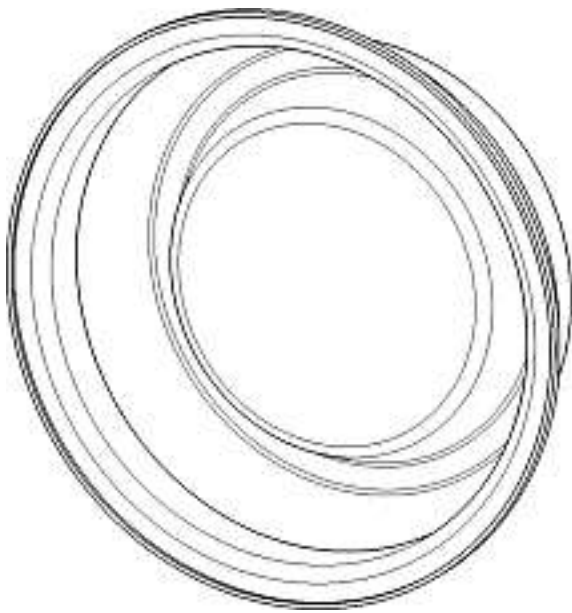

1

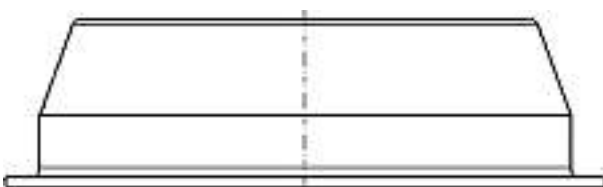
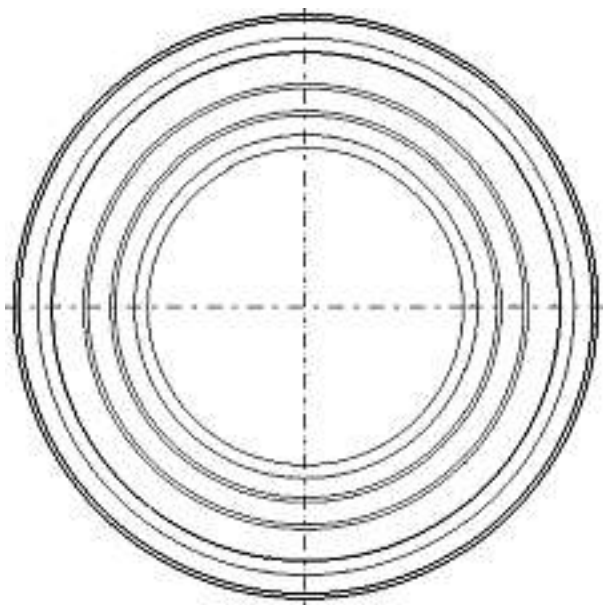
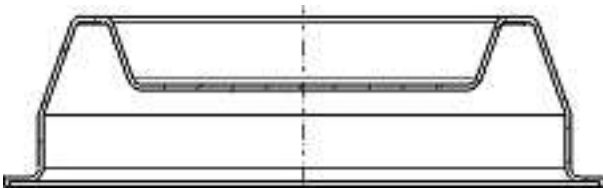

Cl. 09-03 132 424 25.11.2005

2 Design – Geschenkpackungen
 Hinterleger: Diroso Wein AG, Bahnhofstrasse 33,
 3946 Turtmann
 Designer: Hans-Peter Baumann, Turtmann



Original Walliser Apéro-Ring 1



Original Walliser Apéro-Ring 2



1

Cl. 09-03 132 425 16.12.2005
3 design – boîtes pour tabac
Déposant: Philip Morris Products S.A., Quai Jeanrenaud 3,
2000 Neuchâtel
Designer: Vincenzo Disavino, Lausanne
Mandataire: Bovard AG, 3000 Bern 25
Priorité: EM, 27.06.2005; EM, 27.06.2005; EM, 27.06.2005

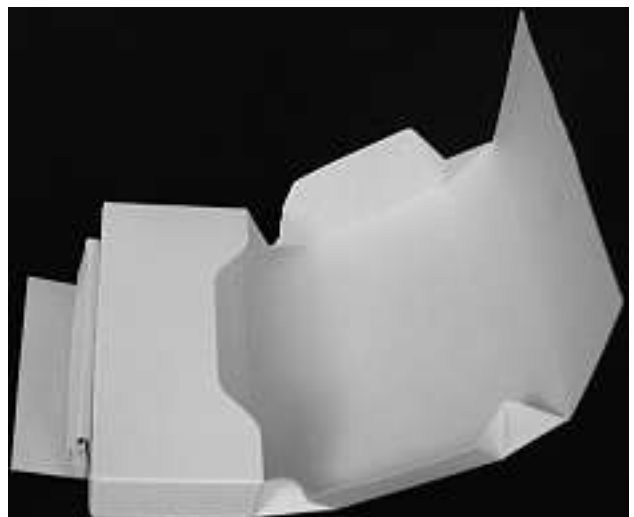
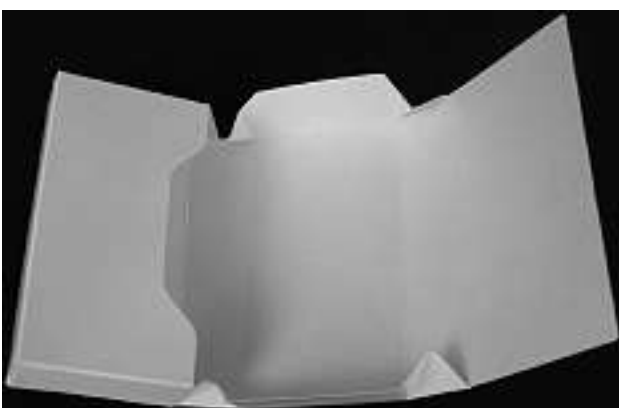

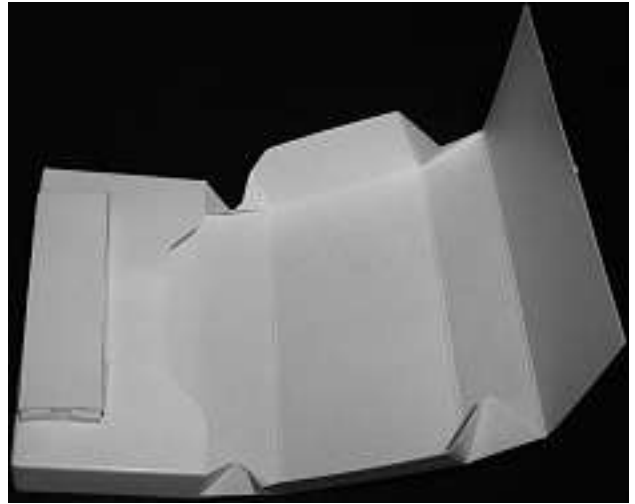
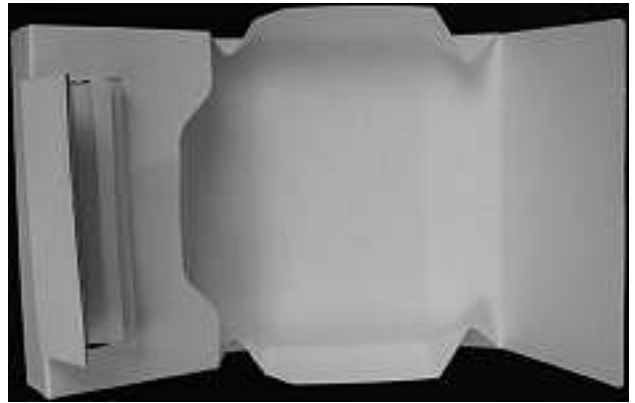
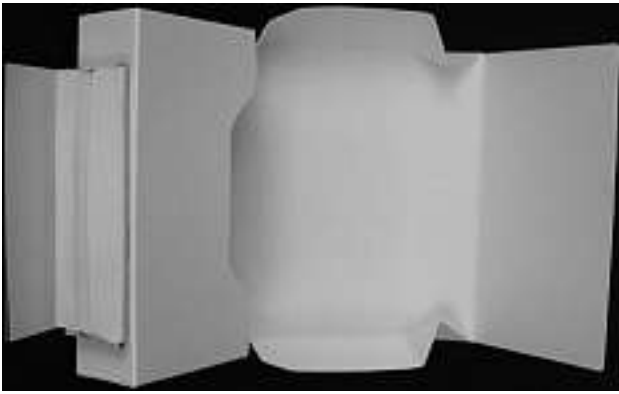

2

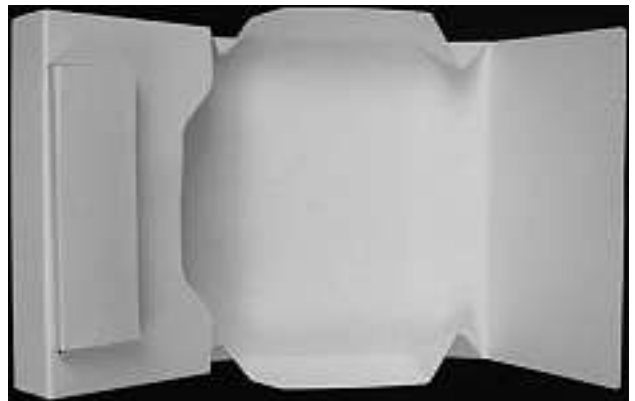

3

Cl. 10-02 132 426 20.12.2005
 1 design – montre-bracelet
 Déposant: SWISSATEC Sàrl, Chemin du Finage 12,
 2350 Saignelégier
 Designer: Pierre-Alain Gilliéron, Tavannes
 Mandataire: CHEVRIER WATCH DISTRIBUTION,
 Jean-François Chèvre, 2502 Bienne



Boll-1/05

Cl. 10-07 132 427 21.12.2005
 14 Design – Uhrzeiger, Uhrzifferblätter
 Hinterleger: THE HOUSE OF EIGHT SA, Rue Pierre-Fatio 12,
 1204 Genève
 Designer: Roland Iten, Le Mont
 Vertreter: Patents & Technology Surveys SA, 2001 Neuchâtel

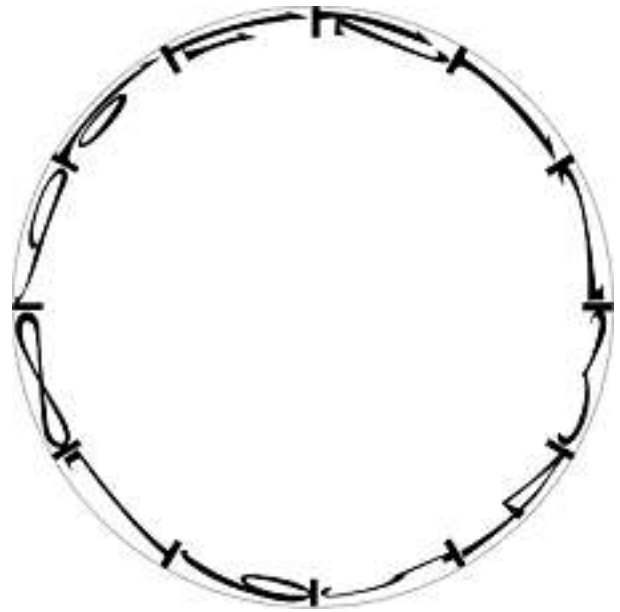

1

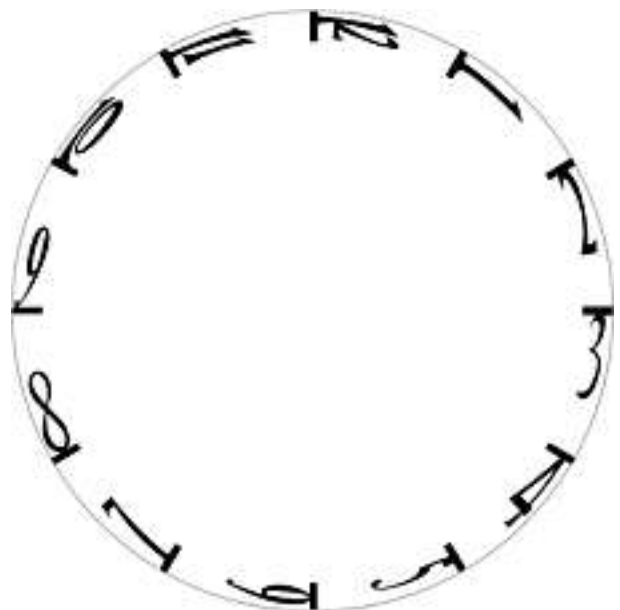

2

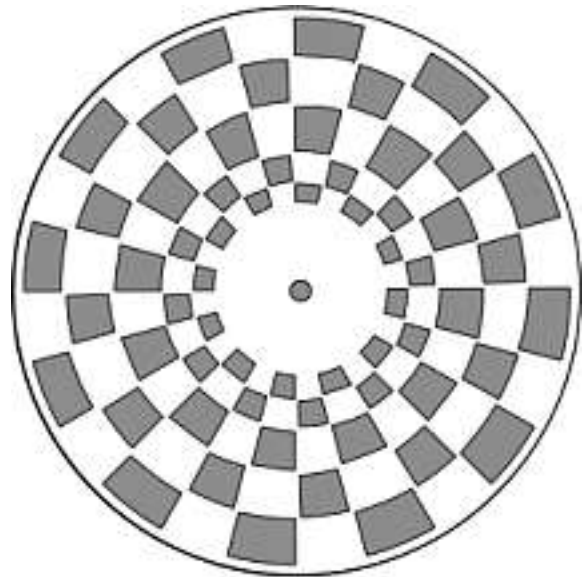
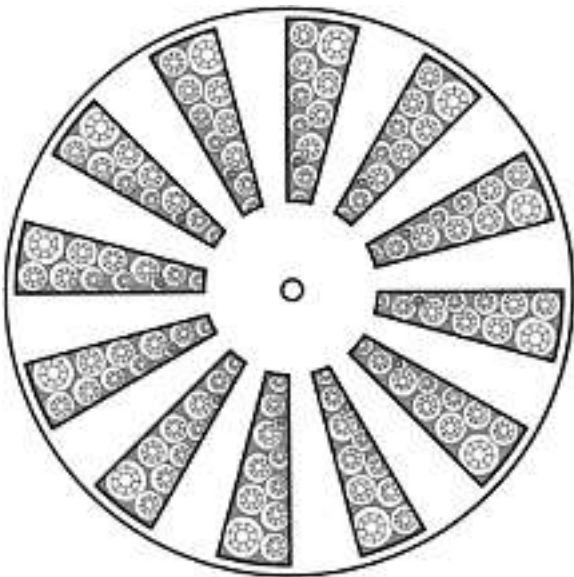

4

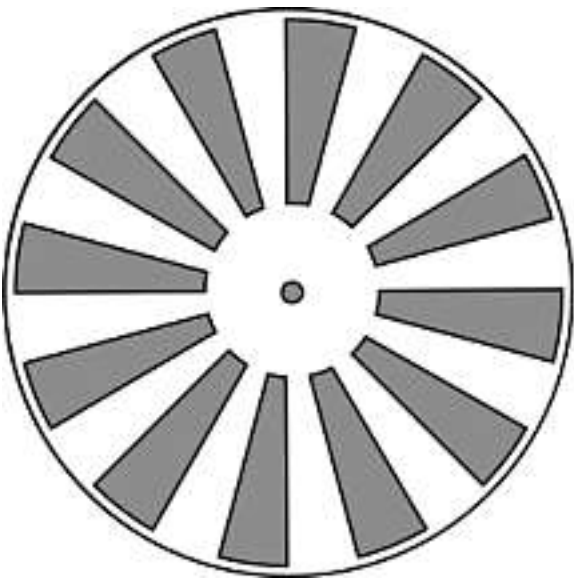

3

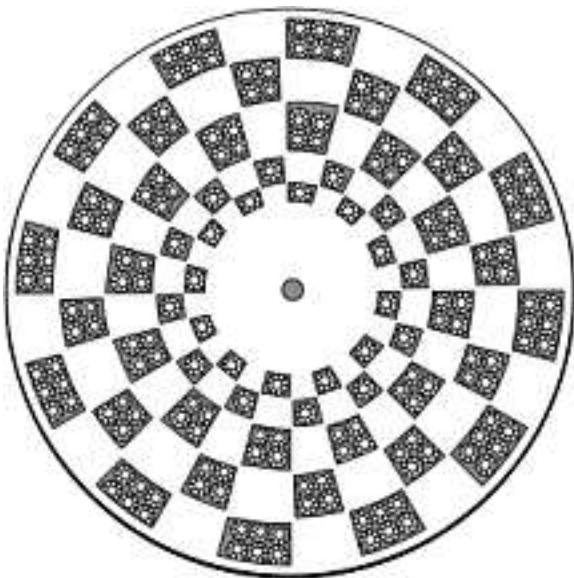
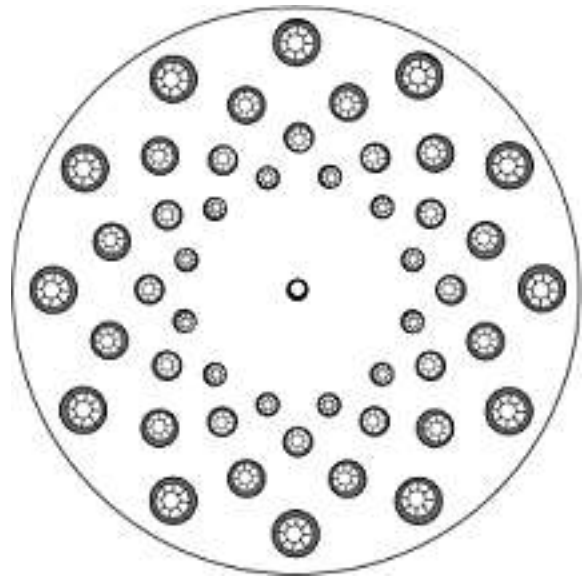

5

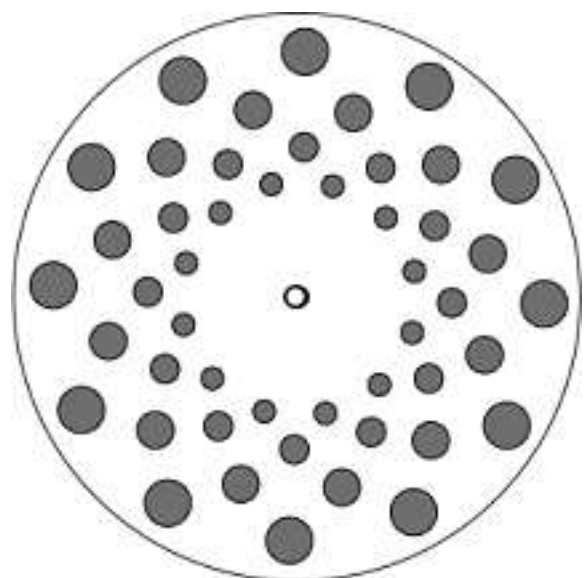

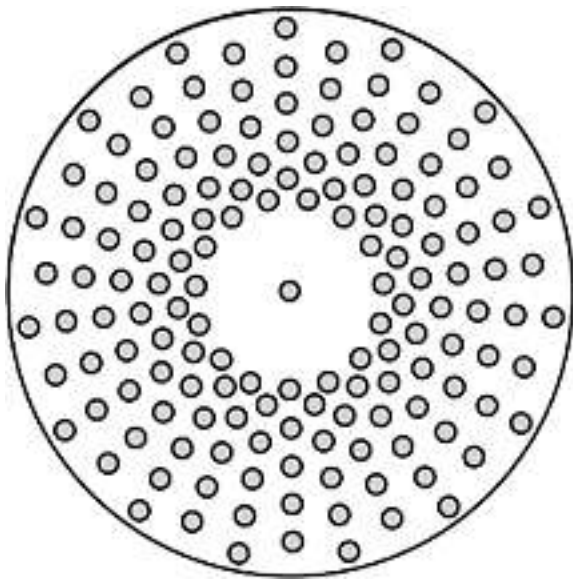
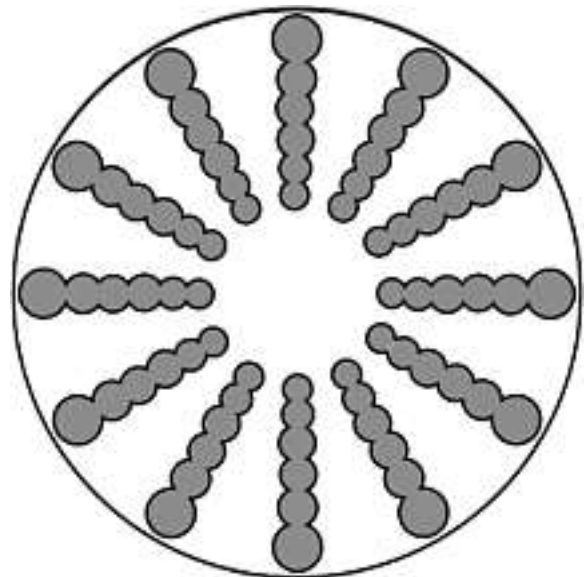
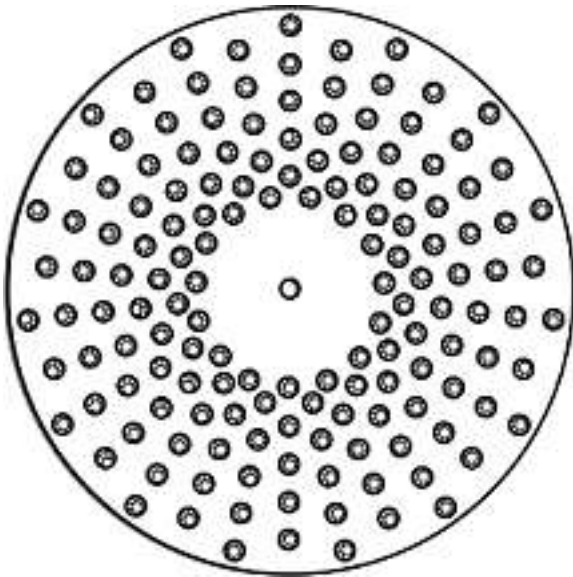

7

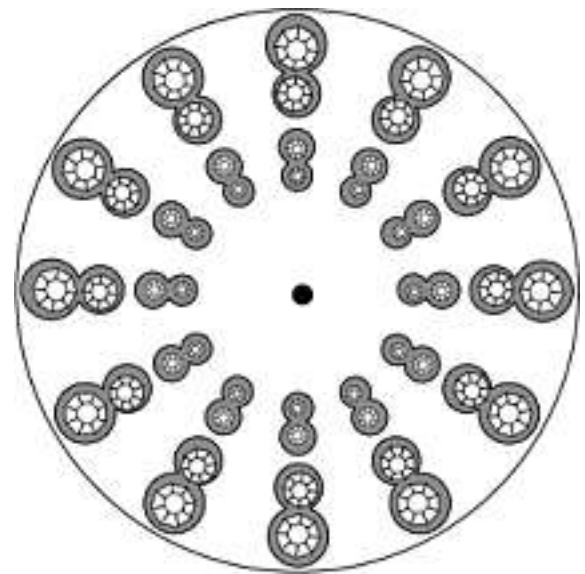

6

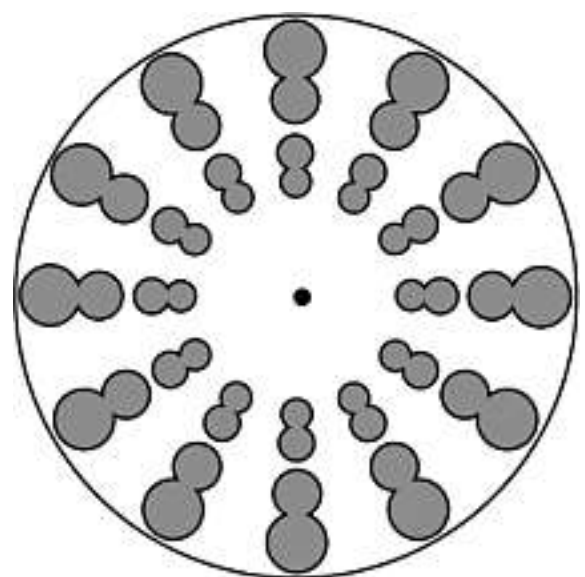
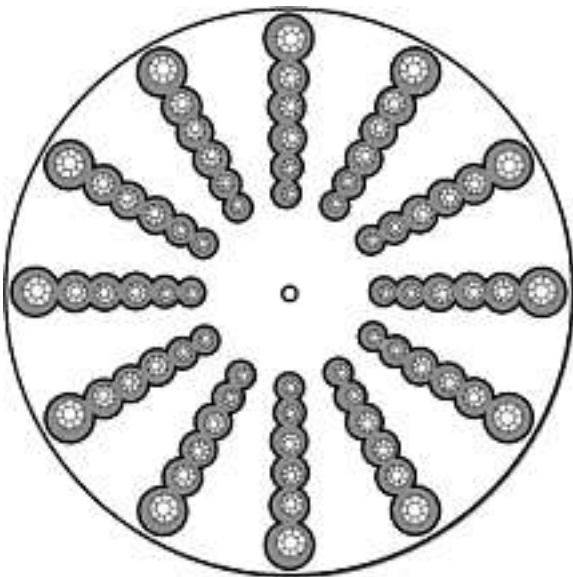

8



9



12



10

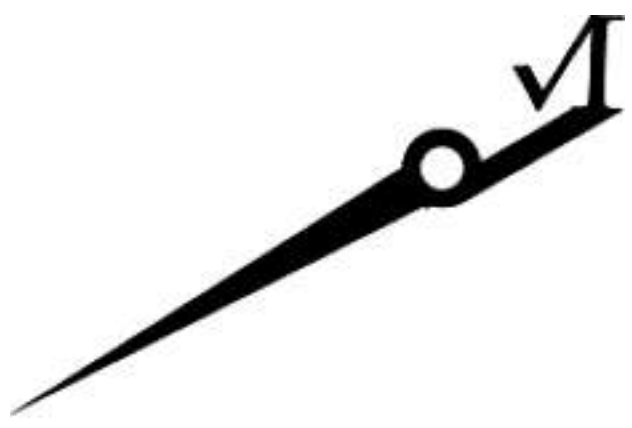

13

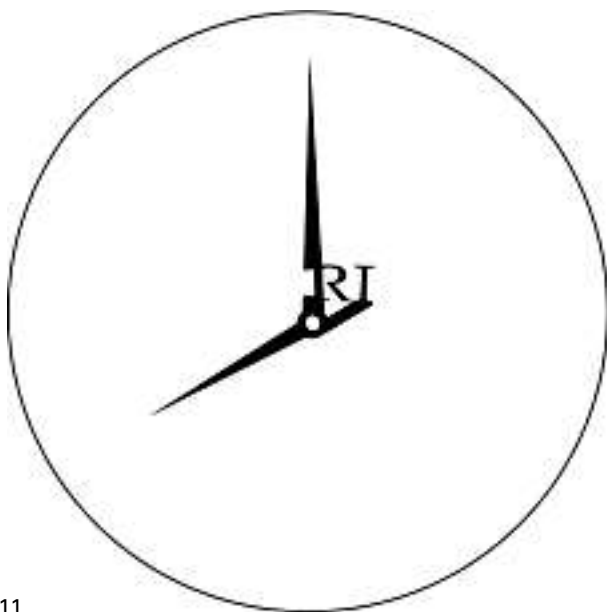

11

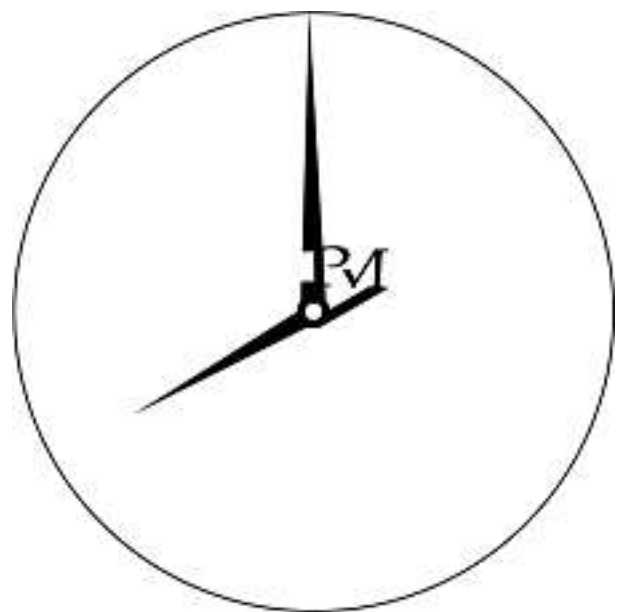

14

Cl. 11-01 132 428 18.12.2005
3 Design – Anhänger (Schmuck)
Hinterleger: Ronzani & Ronzani, Hammerstrasse 58,
8032 Zürich
Designer: Caroline Ronzani, Zürich
Vertreter: Daniel Ronzani, 8032 Zürich

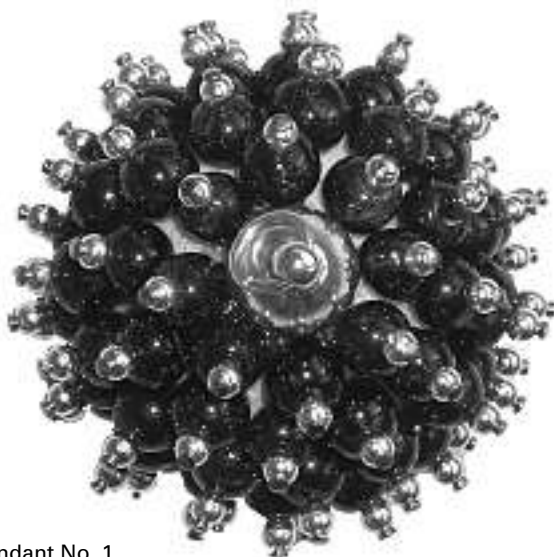

Pendant No. 1

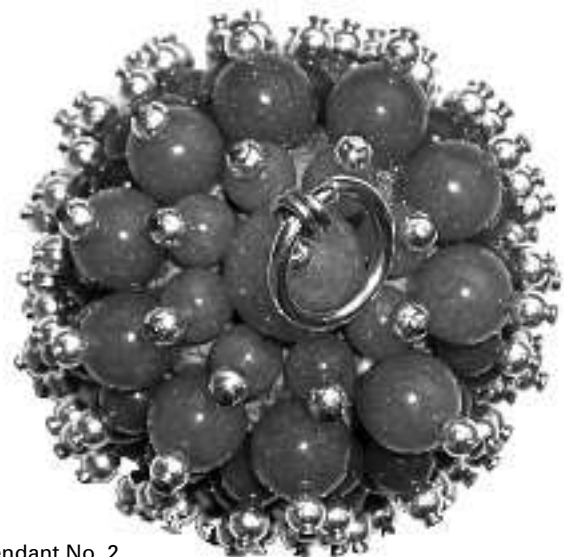
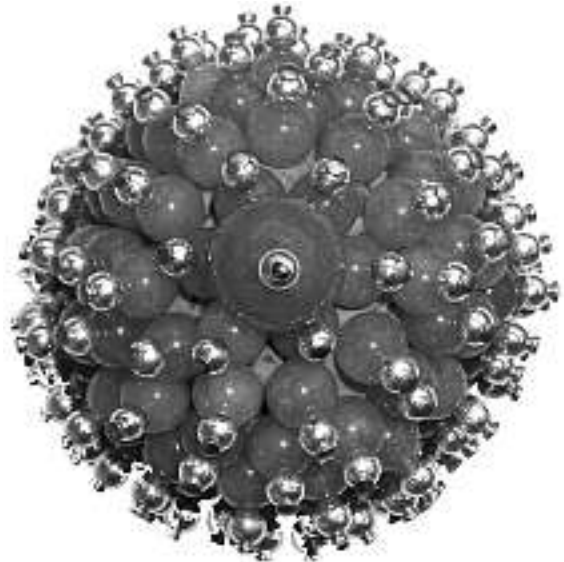
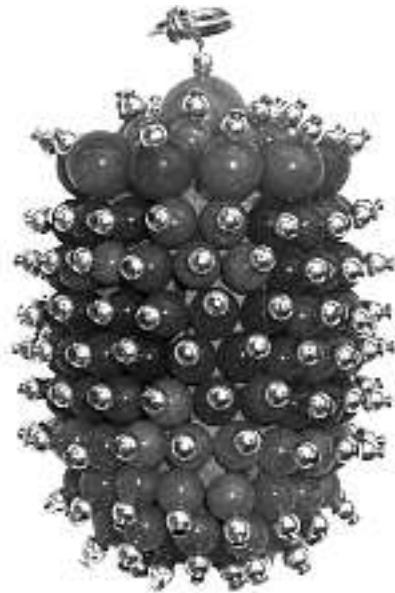

Pendant No. 2



Cl. 11-02 132 429 12.12.2005
 5 Design – Ziergegenstände
 Hinterleger: Mila GmbH, Andernacher Strasse 31,
 Nürnberg, DE
 Designer: Robert Köhler, Nürnberg
 Vertreter: M.I.L.A. Design- und Geschenkartikel GesmbH &
 Co. KG, Wien (A), Zweigniederlassung Wald, 3086 Englisberg



3308



3312



Pendant No. 3



45398



45406



45407

Cl. 11-02 132 430 15.12.2005
 5 Design – Ziergegenstand
 Hinterleger: Santiago Calatrava, Parkring 11, 8002 Zürich
 Vertreter: Luchs & Partner, Patentanwälte, 8002 Zürich

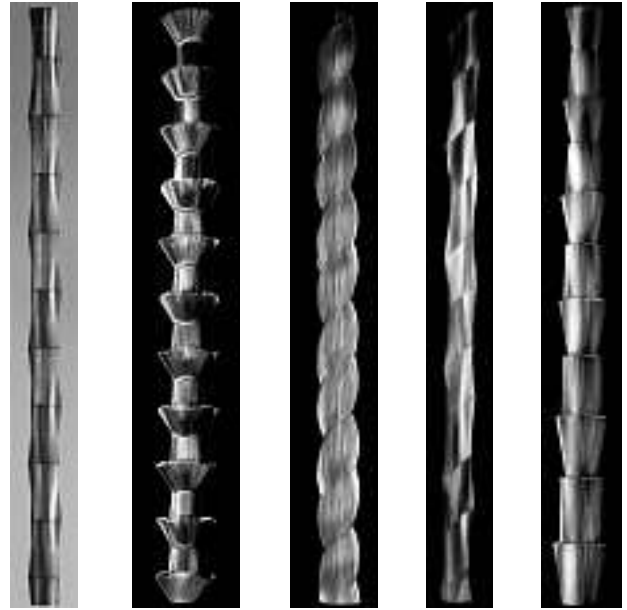

1 2 3 4 5

Cl. 12-16 132 431 18.11.2005

1 Design – Hardtop
 Hinterleger: MITC AG, Hauptstrasse 145, 8274 Tägerwilen
 Designer: Andreas Zeinecke, Tägerwilen
 Vertreter: Arie Wubben, 8942 Oberrieden
 Priorität: DE, 31.05.2005; DE, 16.08.2005
 Beschreibung des Designs: Beschreibung Hardtop für Personenkraftwagen.
 Die vorliegende Geschmacksmusteranmeldung betrifft die Idee und Ausgestaltung eines erfindungsgemässen Hardtops für Personenkraftwagen des Fabrikates Porsche Boxter. Durch Aufsetzen des Hardtops auf den geöffneten Porsche Boxter entsteht die Optik eines Porsche Cayman. Das Hardtop ist vorzugsweise in Carbon-Look oder Kohlefaser-Look gefertigt. Das Hardtop ist in allen möglichen Materialien, wie Metall oder Kunststoff oder Compositewerkstoffe hergestellt. Das Hardtop ist in der jeweiligen Lackierung der PKW Farbe erhältlich.

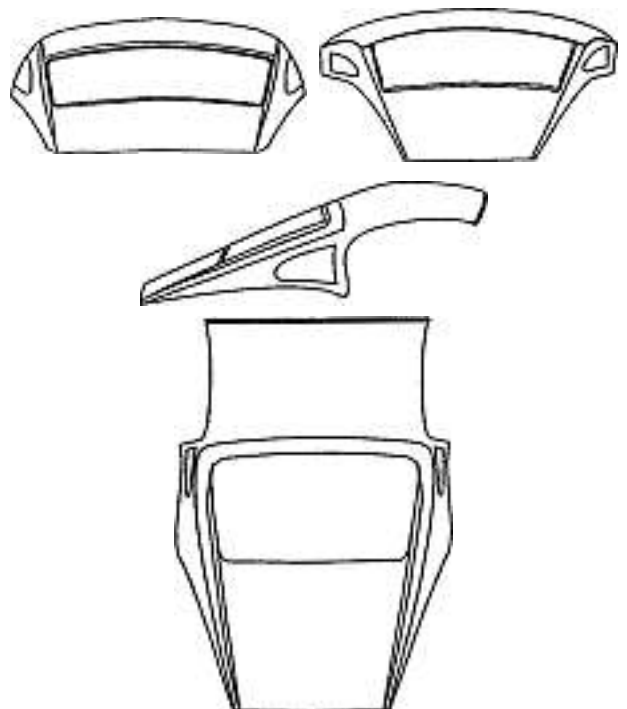

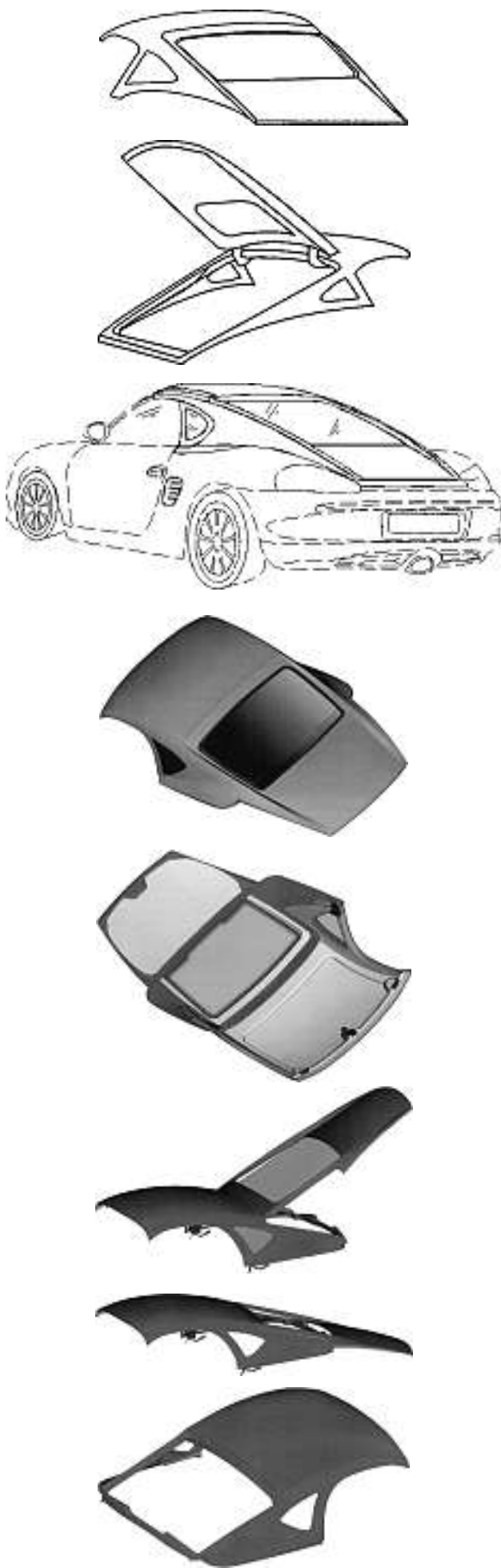

1



Cl. 12-16 **132 432** 22.12.2005
1 design – plaque de désensablement pour véhicule
Déposant: Agruplast Sàrl, Rapille-dessus 29, 1312 Eclépens
Designer: Eric Sangrouber, Eclépens

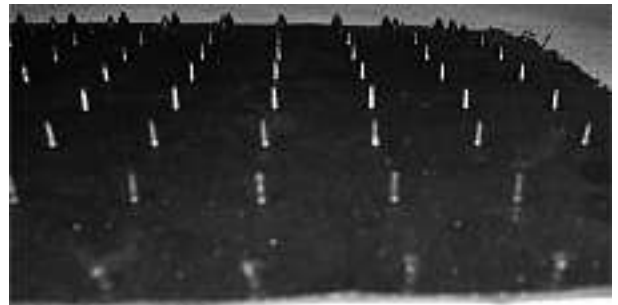
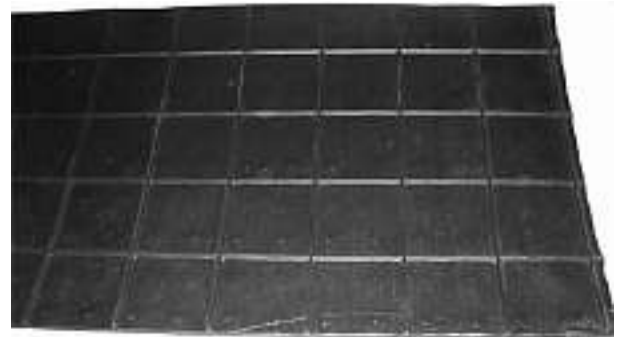

1

Cl. 15-07 132 433 28.12.2005
2 Design – Kühlmöbel
Hinterleger: Linde Kältetechnik GmbH & Co. KG, Sürther
Hauptstrasse 173, 50999 Köln, DE
Designer: Harry Finkenauer, Mainz-Kostheim; Ortwin Schäfer,
Riedstadt
Vertreter: A. Braun, Braun, Héritier, Eschmann AG,
Patentanwälte, 4051 Basel
Priorität: EM, 29.06.2005



1

2

Cl. 20-02 132 434 17.11.2005
 1 Design – Steller
 Hinterleger: Bruno Messerli, Hauptstrasse 106, Brittern,
 4587 Aetingen

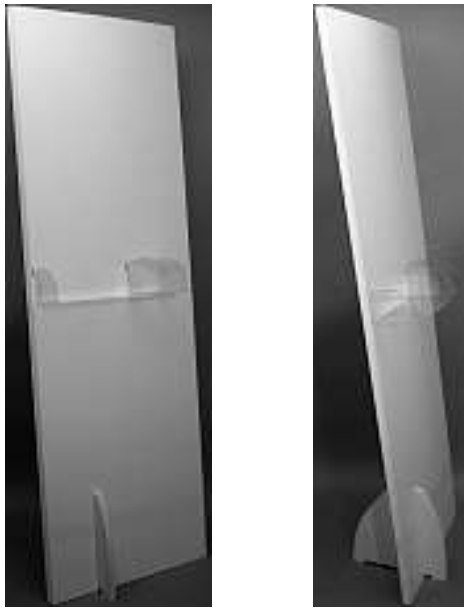

Basissteller

Cl. 21-01 132 435 29.11.2005
 1 Design – Spielbrett
 Hinterleger: Patrik Gubser, c/o TIMUK GmbH, Weberstrasse 7,
 8004 Zürich

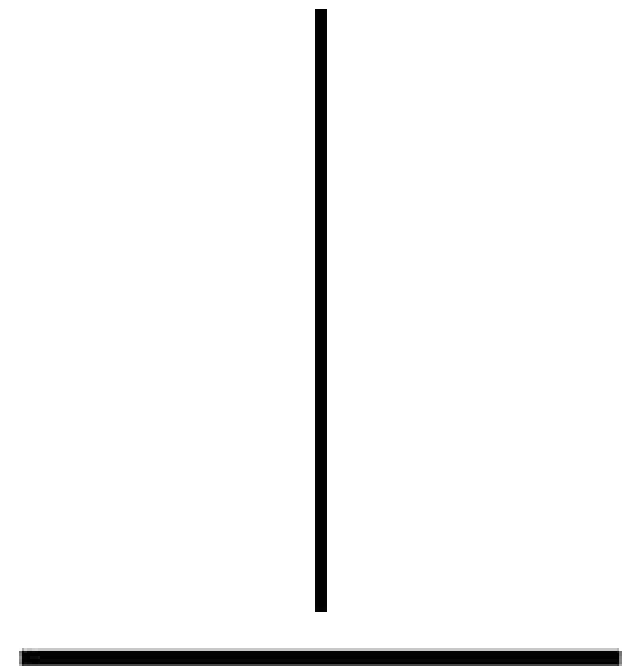
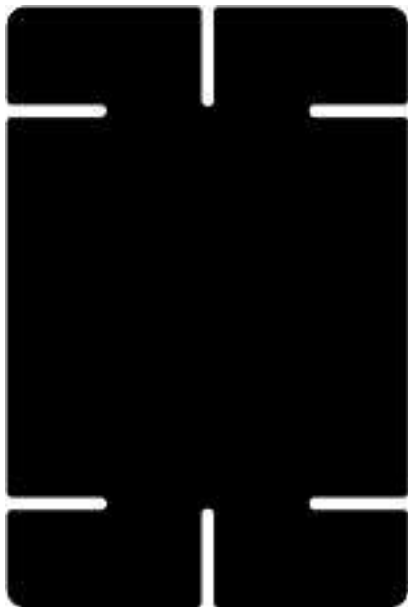

A-Z version 2005

Cl. 21-01 132 436 12.12.2005
 1 Design – Schaukelpferd
 Hinterleger: Hans Bannwart, Hübeli, 6207 Nottwil; Tobias
 Baumann, Hauptstrasse 127, 5056 Attelwil; Niklaus Rohrer,
 Brichenried 2, 6073 Flüeli-Ranft
 Designer: Tobias Baumann, Attelwil; Niklaus Rohrer,
 Flüeli-Ranft
 Vertreter: Niklaus Rohrer, 6073 Flüeli-Ranft





Schaukelpferd 1

Cl. 21-01 132 437 22.12.2005
 1 Design – Spiel
 Hinterleger: Ferdinand Wertmüller, Rückimattweg 16,
 3312 Fraubrunnen



Cl. 21-02 132 439 19.12.2005
 1 design – coque/support pour lame de patin à glace
 Déposant: SPORT MASKA INC., 3400, Raymond-Lasnier
 Street, Montréal, Québec H4R 3L3, CA
 Designer: Philippe Koyess, Montréal
 Mandataire: MICHELI & CIE SA, 1226 Thônex
 Priorité: US, 30.09.2005

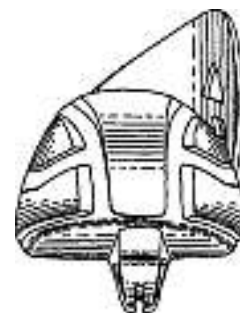
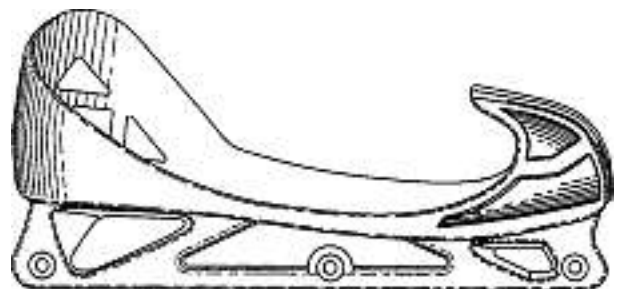
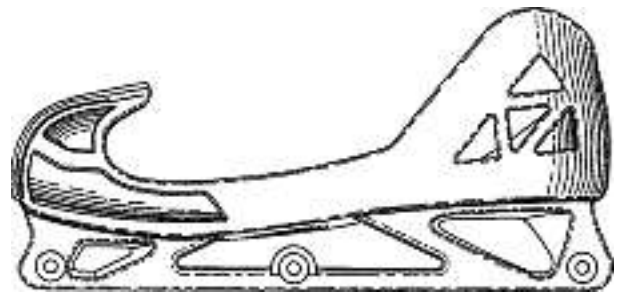
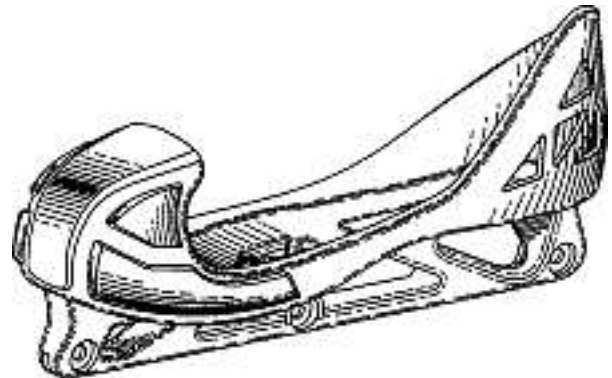

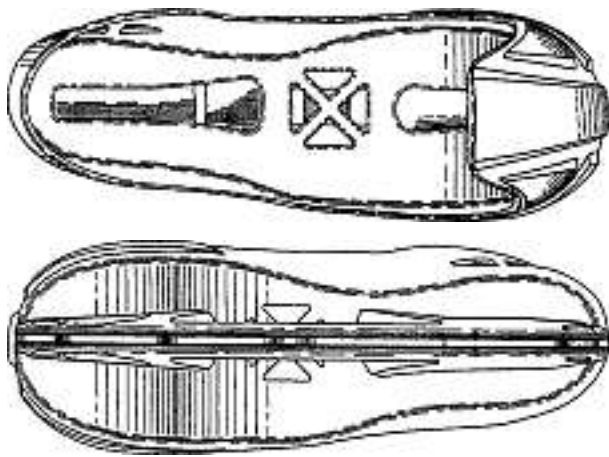

14616A

Cl. 23-01 **132 440** 02.12.2005
 3 Design – Rohrkrümmer für Fluide
 Hinterleger: Naber Holding GmbH & Co. KG,
 Enschedestr. 30, Nordhorn, DE
 Designer: Hans-Joachim Naber, Nordhorn; Wolf-Christoph
 Friebel, Wallenhorst
 Vertreter: R. A. Egli & Co., Patentanwälte, 8008 Zürich

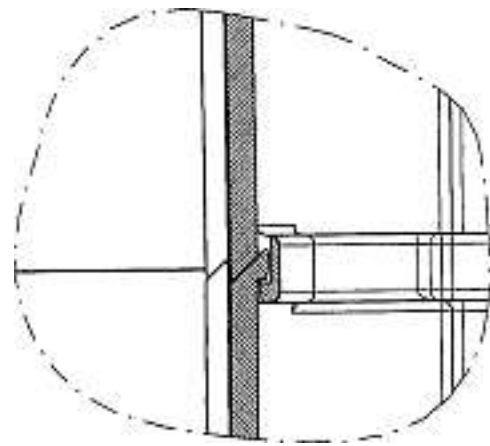
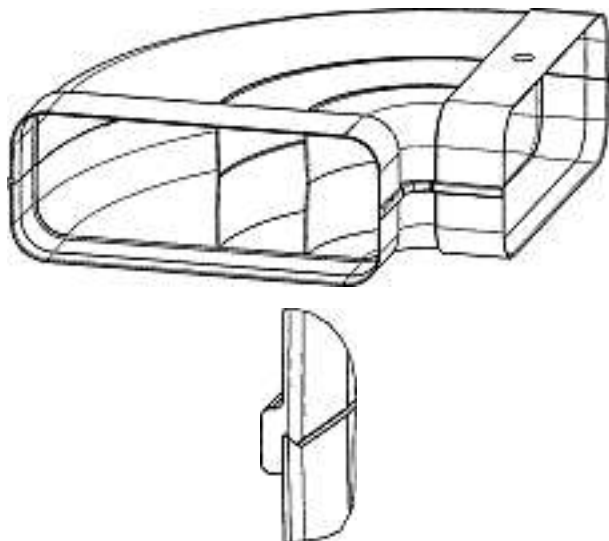

1

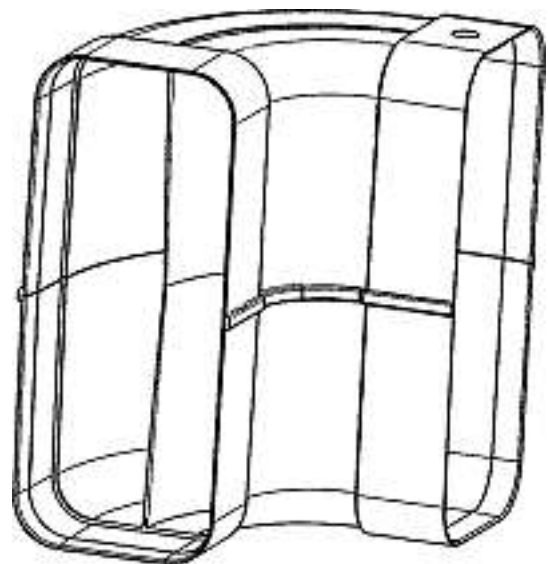

2

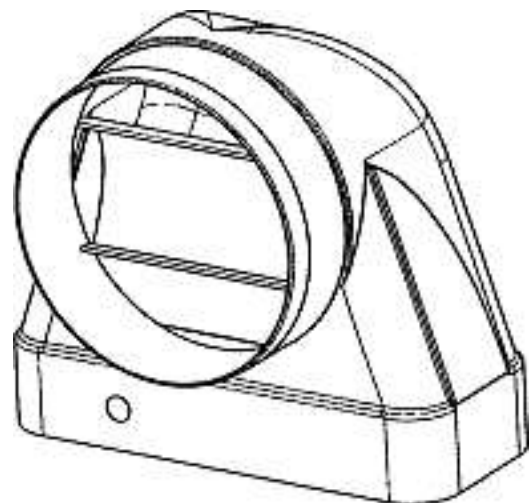

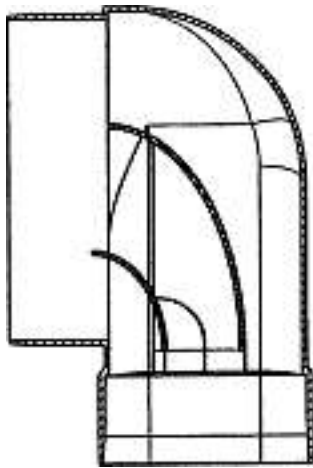

3

Cl. 23-01 **132 441** 22.12.2005
 2 Design – Abgabeventil, Abdeckung für Abgabeventil
 Hinterleger: Nordson Corporation, 28601 Clemens Road,
 Westlake/OH, US
 Designer: Christopher R. Chastine, Hoschton; Matthew
 R. Tinaglia, Suwanee; Richard Pallante, Atlanta
 Vertreter: Schmauder & Partner AG, Patent- und
 Markenanwälte VSP, 8038 Zürich
 Priorität: US, 29.06.2005; US, 29.06.2005

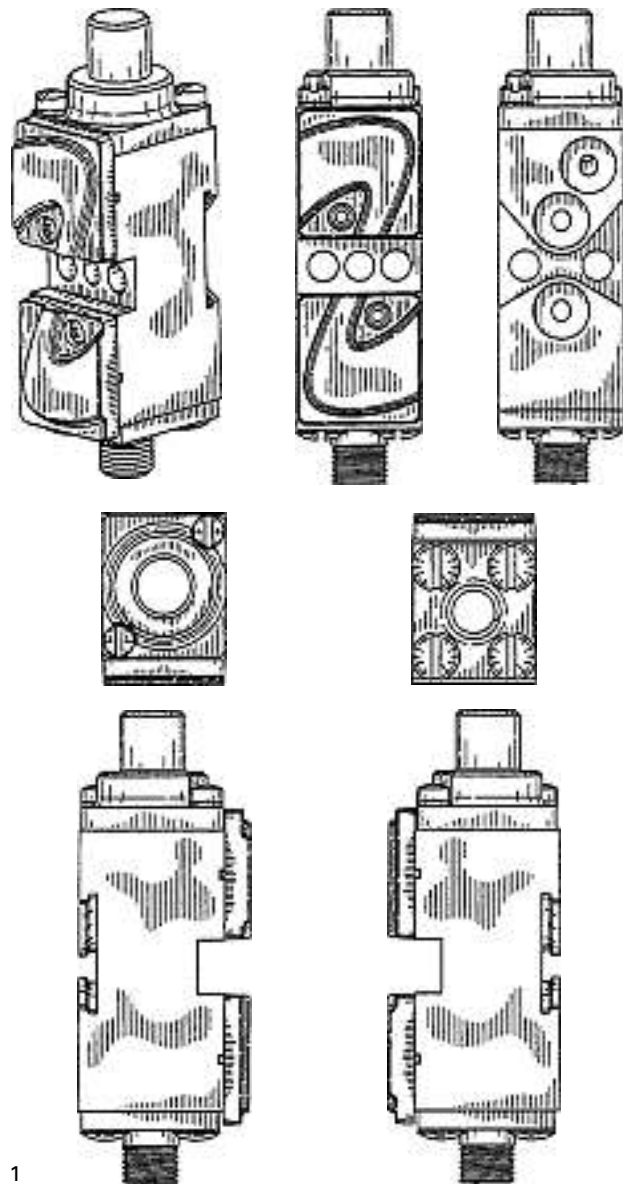

1

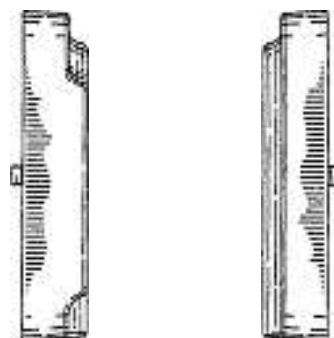
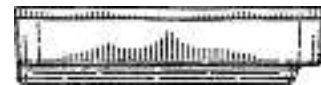
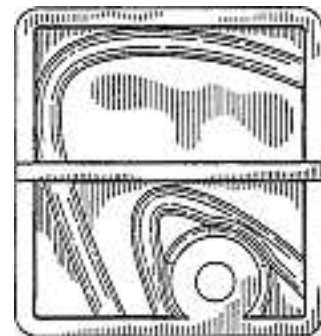
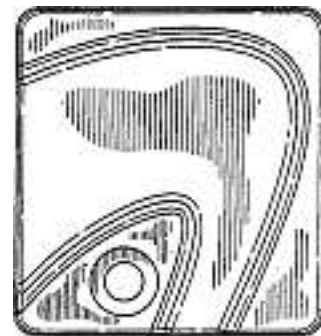
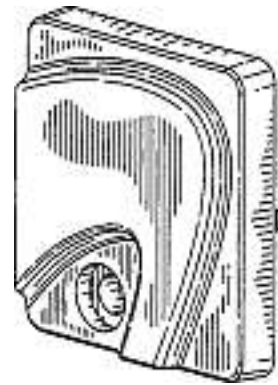

2

Cl. 23-01 132 442 22.12.2005
2 Design – Hydraulische Dichtung
Hinterleger: Nordson Corporation, 28601 Clemens Road,
Westlake/OH, US
Designer: John M. Riney, Buford; Paul S. Frates,
Lawrenceville
Vertreter: Schmauder & Partner AG, Patent- und
Markenanwälte VSP, 8038 Zürich
Priorität: US, 29.06.2005; US, 22.11.2005

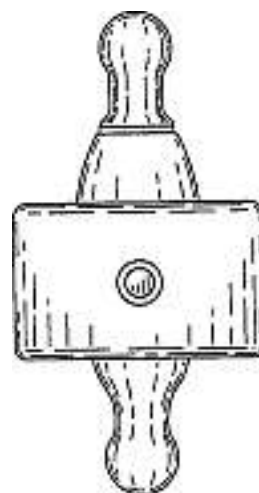
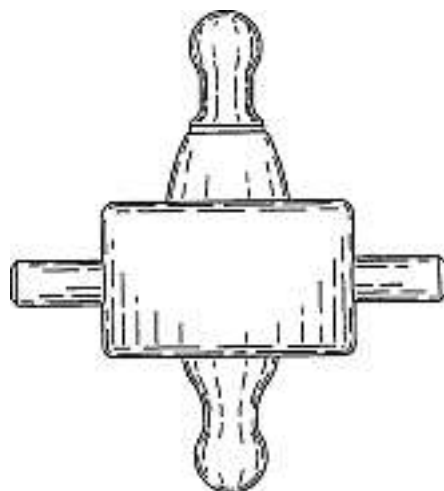
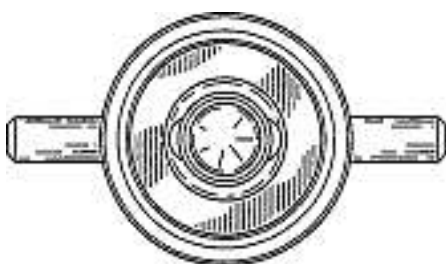
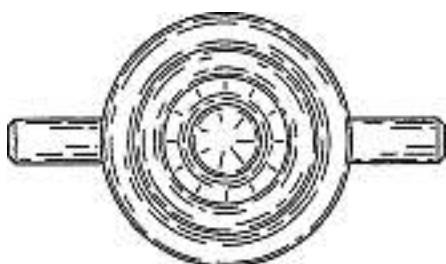
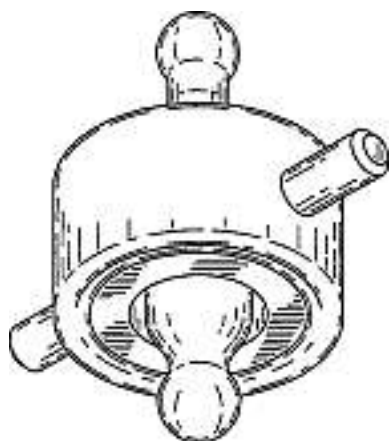
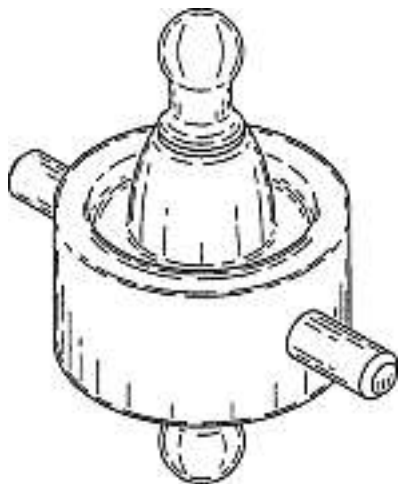

1

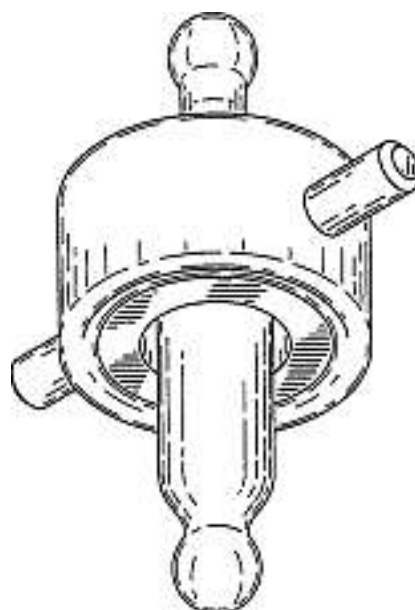

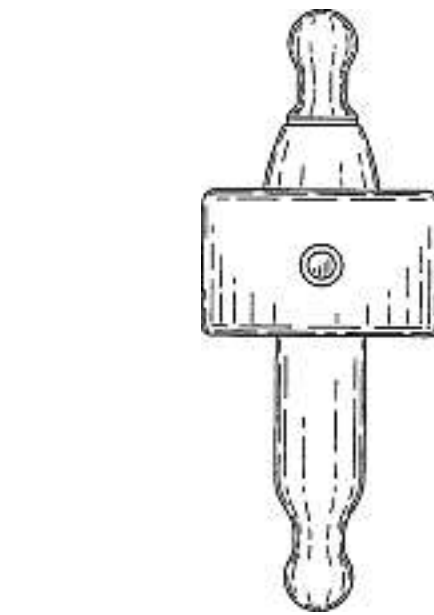
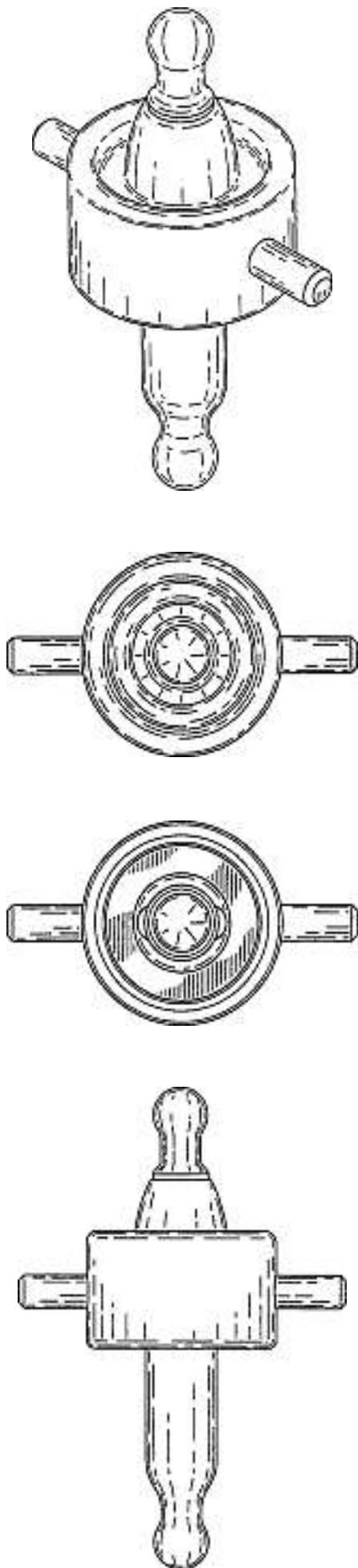

2

Cl. 24-02 **132 443** 12.12.2005
 1 Design – Chirurgisches Instrument (Morzellator)
 Hinterleger: Novvag AG, St. Gallerstrasse 25, 9403 Goldach
 Designer: Beda Hutter, Goldach
 Vertreter: PA Aldo Römpler, 9410 Heiden



1

Cl. 26-01 132 444 18.11.2005
 1 Design – Kerzenständer
 Hinterleger: Evangelisch-reformierte Kirchgemeinde
 Wichtrach, Schulhausstrasse 3, Postfach 191, 3114 Wichtrach
 Designer: Gerhard Gerber, Bern



rut05



dyva bougeoir 1

Cl. 26-01 132 445 22.12.2005
 1 design – bougeoir
 Déposant: Yvan von Allmen, 5, Vieux Châtel, 2000 Neuchâtel



Cl. 26-04 132 446 05.12.2005
 2 Design – Finnenkerzen
 Hinterleger: arbomec ag, Stickereistrasse 6, 9320 Arbon
 Designer: Walter Studerus, Arbon



finnti 35 Liter



finnti 50 Liter



Cl. 31-00 132 449 14.12.2005
1 Design – Kaffeemaschine
Hinterleger: Ernst de Scheemaker, Guggenbühlstrasse 44,
8404 Winterthur

ES01



**Verlängerungen
Prolongations
Prolongazioni**

118 454 Cl. 11-01 1 design



1

118 685 Cl. 06-01 1 Design



695722

118 693 Cl. 12-15 1 design



281

118 752 Cl. 09-01 1 Design



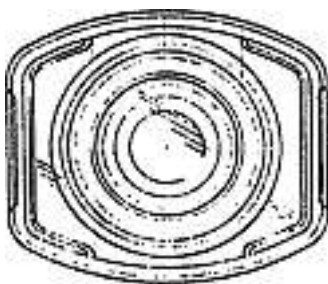
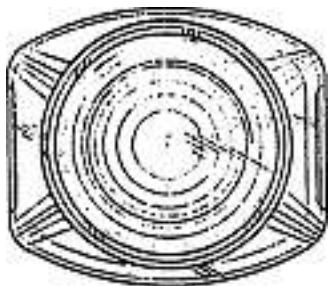
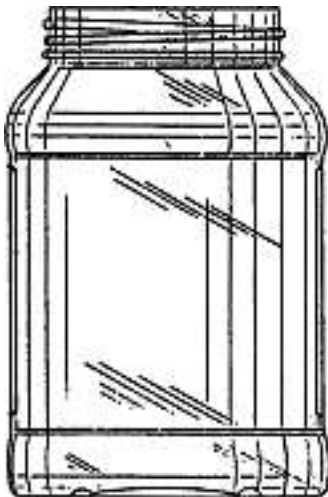
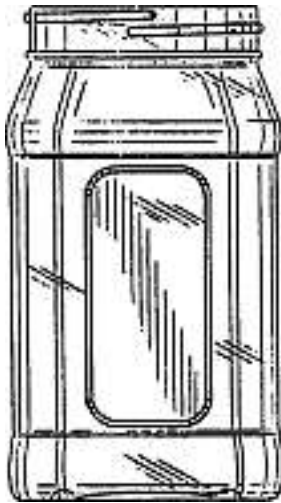

122 445	Cl.	10-07	1 Design
123 004	Cl.	19-06	1 Design
123 019	Cl.	07-02	1 Design
123 032	Cl.	10-07	1 design
123 085	Cl.	21-01	1 Design
123 087	Cl.	21-01	1 Design
123 088	Cl.	24-02	3 Design
123 230	Cl.	20-03	1 Design
127 526	Cl.	03-01	1 Design
127 609	Cl.	06-01	1 Design
127 612	Cl.	06-01	5 Design
127 625	Cl.	07-03	1 Design
127 628	Cl.	07-99	1 Design
127 672	Cl.	07-01	1 Design
127 689	Cl.	23-03	1 Design
127 692	Cl.	25-02	1 Design
127 694	Cl.	99-00	1 Design
127 697	Cl.	03-01	1 Design
127 760	Cl.	20-03	2 design
127 850	Cl.	14-02	1 Design
127 884	Cl.	10-02	1 design
127 887	Cl.	10-07	1 Design
127 895	Cl.	20-01	5 design
127 912	Cl.	10-03	1 design
127 921	Cl.	21-02	1 Design
127 961	Cl.	21-03	2 Design
128 029	Cl.	16-06	6 Design

Mutationen
Modifications
Modificazioni

123 004

Neuer Vertreter
 Vertreter: Isler & Pedrazzini AG, 8023 Zürich

123 019

Neuer Vertreter
 Vertreter: Hepp Wenger Ryffel AG, 9500 Wil SG

127 697

Neuer Vertreter
 Vertreter: Braunpat Braun Eder AG, 4015 Basel

130 808

Übertragung
 Hinterleger: Herzog & de Meuron Architekten AG,
 Rheinschanze 6, 4056 Basel
 Vertreter: AXON Patent GmbH, 4147 Aesch

Löschungen
Radiations
Radiazioni

118 320	Cl.	19-08	1	Design
118 321	Cl.	19-08	2	Design
118 322	Cl.	19-08	1	Design
118 323	Cl.	19-08	2	Design
118 365	Cl.	14-01	2	Design
118 385	Cl.	06-04	2	Design
118 415	Cl.	04-02	2	Design
122 427	Cl.	01-01	65	Design
122 431	Cl.	06-01	45	Design
122 434	Cl.	06-06	3	Design
122 446	Cl.	10-07	2	design
122 461	Cl.	21-01	1	Design
122 462	Cl.	21-01	14	Design
127 135	Cl.	06-01	2	Design
127 137	Cl.	06-01	25	design
127 138	Cl.	06-01	38	Design
127 139	Cl.	06-01	40	Design
127 140	Cl.	06-04	2	Design
127 141	Cl.	06-04	5	Design
127 142	Cl.	06-06	1	design
127 146	Cl.	09-01	1	Design
127 148	Cl.	09-03	1	Design
127 150	Cl.	10-02	10	Design
127 151	Cl.	10-02	4	design
127 152	Cl.	10-07	8	Design
127 153	Cl.	11-01	14	design
127 155	Cl.	12-02	1	Design
127 156	Cl.	12-10	5	Design
127 157	Cl.	14-02	1	Design
127 161	Cl.	15-05	1	design
127 162	Cl.	15-05	1	design
127 164	Cl.	20-03	3	Design
127 166	Cl.	21-01	2	Design
127 168	Cl.	25-01	2	Design
127 170	Cl.	25-04	1	Design
127 173	Cl.	26-05	1	Design
127 283	Cl.	08-03	6	Design
127 287	Cl.	09-03	2	Design

Berichtigungen
Rectifications
Rettifiche

130 808

Berichtigung:

Der Designer lautet korrekterweise
Jacques Herzog, Basel

Topographien

Löschungen
Radiations
Radiazioni

T0004

T0008

T0010