

Nationale Hinterlegungen

In der folgenden Liste werden die beim Eidgenössischen Institut für Geistiges Eigentum hinterlegten Designs publiziert. Dabei sind der Reihe nach angegeben:

- internationale Klassenangaben
- Hinterlegungsnummer
- Hinterlegungsdatum
- Allenfalls Aufschub der Veröffentlichung
- Anzahl der hinterlegten Designs
- Bezeichnung
- Name und Wohnsitz des Hinterlegers oder der Hinterlegerin
- gegebenenfalls Name und Wohnsitz des Designers oder der Designerin
- Name und Geschäftssitz des allfälligen Vertreters oder der Vertreterin
- gegebenenfalls Prioritätsangaben
- gegebenenfalls Beschreibungstext
- Ordnungsnummer
- Reproduktion des Designs

Internationale Hinterlegungen

Die bei der Weltorganisation für geistiges Eigentum in Genf hinterlegten Muster und Modelle mit Benennung Schweiz geniessen den gleichen Schutz wie national hinterlegte Designs. Sie werden jeweils im Blatt «Bulletin des dessins et modèles internationaux» veröffentlicht. Dieses Publikationsorgan ist deshalb für eine vollständige Recherche unbedingt beizuziehen.

Topographien

Angaben über die vom Eidgenössischen Institut für Geistiges Eigentum eingetragenen Topographien von Halbleitererzeugnissen werden in folgender Anordnung aufgeführt:

- Eintragsnummer
- Anmeldedatum
- Bezeichnung
- Name und Wohnsitz des Anmelders oder der Anmelderin
- gegebenenfalls Name und Wohnsitz des Herstellers oder der Herstellerin
- Name und Geschäftssitz des oder der allfälligen Bevollmächtigten
- Datum und Ort einer allfälligen ersten geschäftlichen Verbreitung der Topographie

Dépôts nationaux

Les designs déposés à l'Institut Fédéral de la Propriété Intellectuelle sont publiés dans la liste qui suit. Les indications y relatives sont mentionnées dans cet ordre:

- indications des classes internationales
- numéro de dépôt
- date de dépôt
- le cas échéant, ajournement de la publication
- nombre des designs déposés
- désignation
- nom et domicile du/de la déposant/e
- le cas échéant, nom et domicile du/de la designer
- nom et domicile de l'éventuel/le mandataire
- le cas échéant, indication de priorité
- le cas échéant, description du design
- numéro attribué à chaque design
- reproduction du design

Dépôts internationaux

Les dessins et modèles déposés à l'Organisation Mondiale de la Propriété Intellectuelle à Genève qui désignent la Suisse jouissent de la même protection que les dépôts nationaux. Ils sont chaque fois publiés dans la feuille «Bulletin des dessins et modèles internationaux». Pour une recherche complète, il est indispensable de consulter ledit organe de publication.

Topographies

Les indications concernant les topographies des produits semi-conducteurs, enregistrées par l'Institut Fédéral de la Propriété Intellectuelle, sont énumérées dans l'ordre suivant:

- numéro d'enregistrement
- date de dépôt
- désignation
- nom et domicile du/de la déposant/e
- le cas échéant, nom et domicile du/de la producteur/trice
- nom et domicile de l'éventuel/le mandataire
- date et lieu d'une éventuelle première mise en circulation de la topographie

Depositi nazionali

Nella lista seguente vengono pubblicati i design depositati presso l'Istituto Federale della Proprietà Intellettuale. Sono menzionati nel seguente ordine:

- indicazioni delle classi internazionali
- numero di deposito
- data del deposito
- se del caso, indicazione che la pubblicazione è stata differita
- numero dei design depositati
- designazione
- nome e domicilio del depositante
- se del caso, nome e domicilio del designer
- nome e sede di un eventuale mandatarario
- se del caso, indicazioni di priorità
- se del caso, descrizione del design
- numero d'ordine
- riproduzione del design

Depositi internazionali

I disegni e modelli depositati presso l'Organizzazione Mondiale della Proprietà Intellettuale a Ginevra con denominazione Svizzera godono della medesima protezione del deposito nazionale. Essi vengono pubblicati ogni volta nel foglio «Bulletin des dessins et modèles internationaux». Quest'organo di pubblicazione è da consultare se si vuole effettuare una ricerca completa.

Topografie

Le indicazioni concernenti le topografie di prodotti a semiconduttori depositati presso l'Istituto Federale della Proprietà Intellettuale sono menzionate nell'ordine seguente:

- numero di registrazione
- data del deposito
- designazione
- nome e domicilio del/la richiedente
- se del caso, nome e domicilio del/la produttore/trice
- nome e sede di un eventuale mandatarario
- data e luogo di un'eventuale prima messa in circolazione della topografia

**Hinterlegungen
Dépôts
Deposit**

Cl. 06-04 129 099 27.10.2002
3 design – bibliothèques
Déposant: Nouha Baghdadi, chemin Porchat 28,
1004 Lausanne
Fin de la période ajournement de la publication



Variations 1

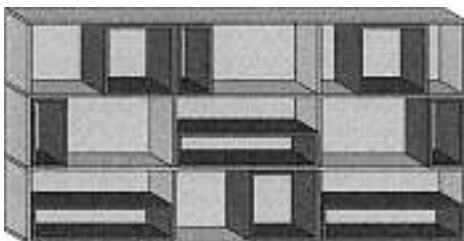

Variations 2

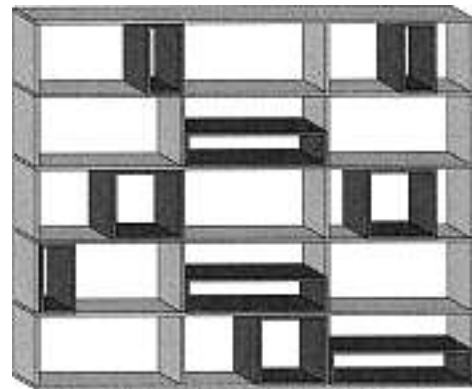
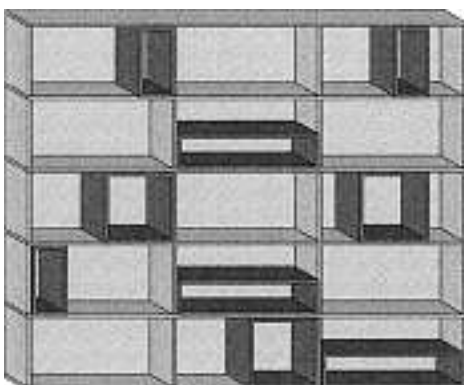

Variations 3

Cl. 06-09 129 134 19.10.2002
1 Design – Matratze
Hinterleger: Sirona Bettwaren AG, Ulmenweg 3b,
8856 Tuggen
Designer: René Knobel, Tuggen
Ende aufgeschobene Publikation



1001-02

Cl. 06-09 129 135 19.10.2002
1 Design – Matratzenhülle
Hinterleger: Sirona Bettwaren AG, Ulmenweg 3b,
8856 Tuggen
Designer: René Knobel, Tuggen
Ende aufgeschobene Publikation



1001-03

Cl. 06-09 129 136 19.10.2002
1 Design – Matratzenhülle
Hinterleger: Sirona Bettwaren AG, Ulmenweg 3b,
8856 Tuggen
Designer: René Knobel, Tuggen
Ende aufgeschobene Publikation



1001-04

Cl. 02-07 131 627 29.03.2005
2 Design – Manschettenknöpfe
Hinterleger: Milus International SA, Reuchenettestrasse 19,
2502 Biel/Bienne
Designer: Janos Edöcs, Biel/Bienne
Vertreter: Zimmerli, Wagner & Partner AG, 8001 Zürich

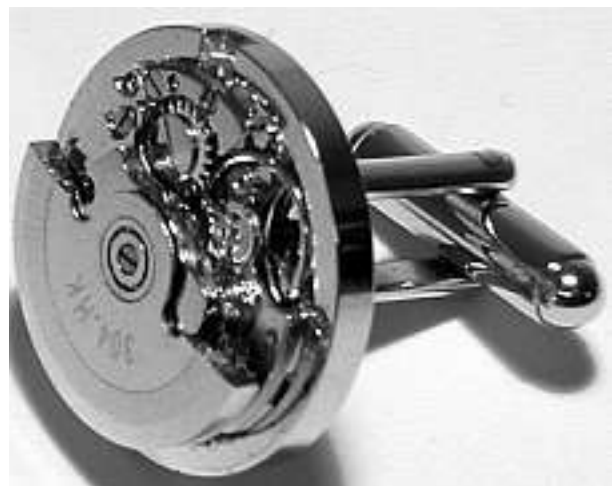
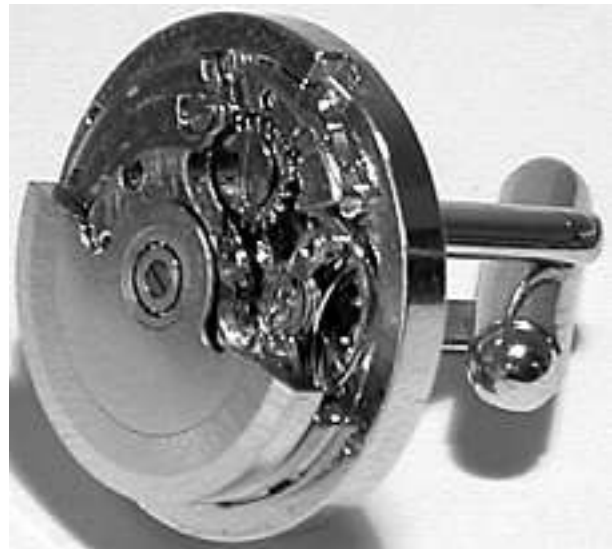
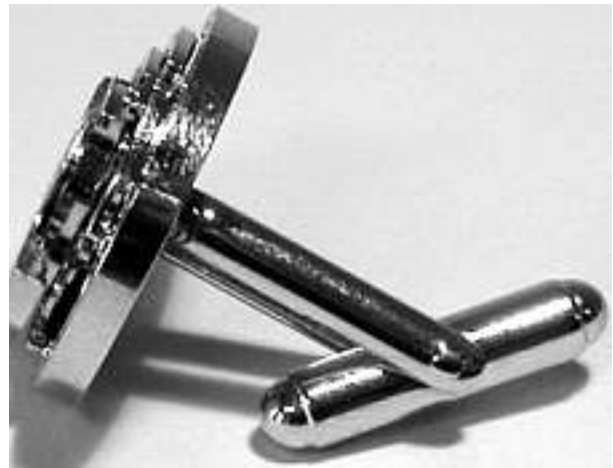



1



2

Cl. 03-01 **131 628** 11.03.2005
 2 Design – Anhänger
 Hinterleger: Jorgen Kruuse A/S, Marslev Byvej 35, Marslev, DK
 Designer: Ivan Kristensen, Frederiksberg
 Vertreter: PA Aldo Römpler, 9410 Heiden
 Priorität: EM, 21.12.2004



1



2

Cl. 05-05 **131 629** 22.03.2005
 1 Design – Stoffapplikation
 Hinterleger: Marco Weiss, In der Mühle 1, 8340 Hinwil



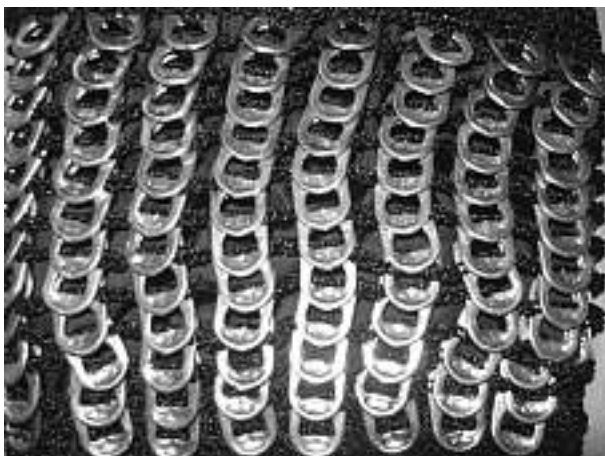
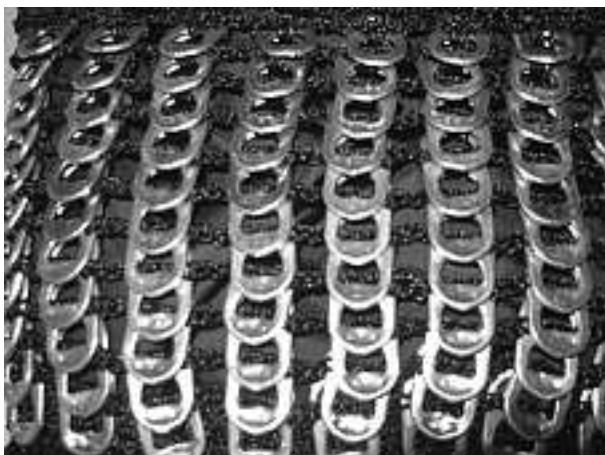

D001

Cl. 06-01, 06-03, 06-11 131 630 15.03.2005
37 Design – Polstermöbel, Sessel, Stühle, Tisch, Beistelltisch, Teppich

Hinterleger: Rolf Benz AG & Co. KG,
Haiterbacher Strasse 104, 72202 Nagold, DE
Designer: Norbert Beck, Markdorf; Christian Werner,
Hollenstedt/Appel; Petra Stützel, Reutlingen; Georg
Appeltshäuser, Stuttgart; Irmgard Hesse, München; Joachim
Nees, Schöllkrippen; Jürgen Braun, Stuttgart; Nicolas
Maniatis, Stuttgart; Max Wehberg, Hamburg; Jan von
Borstel, Hamburg; Edgar Reuter, Donzdorf; Ulrich Böhme,
Stuttgart; Katja Reiter, Nürnberg; Bettina Hermann, Nagold
Vertreter: Bovard AG, 3000 Bern 25

Priorität: EM, 05.10.2004; EM, 05.10.2004; EM, 05.10.2004;
EM, 05.10.2004; EM, 05.10.2004; EM, 05.10.2004; EM,
05.10.2004; EM, 05.10.2004; EM, 05.10.2004; EM, 05.10.2004;
EM, 05.10.2004; EM, 05.10.2004; EM, 05.10.2004; EM,
05.10.2004; EM, 05.10.2004; EM, 05.10.2004; EM, 05.10.2004;
EM, 05.10.2004; EM, 05.10.2004; EM, 05.10.2004; EM,
05.10.2004; EM, 05.10.2004; EM, 05.10.2004; EM, 05.10.2004;
EM, 05.10.2004; EM, 05.10.2004; EM, 05.10.2004; EM,
05.10.2004; EM, 05.10.2004; EM, 05.10.2004; EM,
05.10.2004; EM, 05.10.2004; EM, 05.10.2004



1



2



3





4



5



6



7



8



9



10





11



12



13



14



15



16



17



18



19

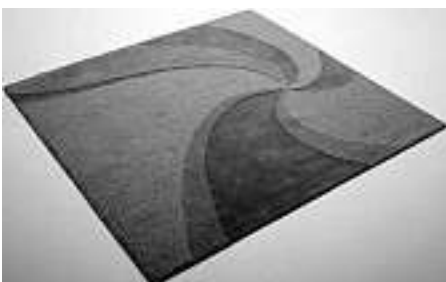

20



21



22



23



24



25



26



27



28



29





30



31



32



33



34



35





36



37

Cl. 06-01 **131 631** 24.03.2005
12 Design – Sitz- und Liegemöbel
Hinterleger: MCA-Agentur Establishment, Industriestrasse 4,
Bendern-Gamprin, LI
Designer: Patrick Poltera, Bendern-Gamprin; Werner Leutert,
Altnau
Vertreter: Büchel, von Révy & Partner, Patentanwälte,
9500 Wil SG



K-D-50274-CH/1



K-D-50274-CH/2



K-D-50274-CH/3



K-D-50274-CH/4





K-D-50274-CH/5





K-D-50274-CH/6



K-D-50274-CH/7





K-D-50274-CH/8



K-D-50274-CH/9



K-D-50274-CH/10





K-D-50274-CH/11



K-D-50274-CH/12

Cl. 06-03 131 632 10.03.2005
 1 Design – Tisch
 Hinterleger: Möbelfabrik Seon AG, Aaraustrasse 4,
 5703 Seon
 Designer: Werner Baumhagl, Meisterschwanden



XENO

Cl. 06-03 131 633 18.03.2005
 2 Design – Tische
 Hinterleger: Möbelfabrik Seon AG, Aaraustrasse 4,
 5703 Seon
 Designer: Norbert Beck, Markdorf





Ironwood 1



Ironwood 2

Cl. 06-03 **131 634** 18.03.2005
 2 Design – Tische
 Hinterleger: Möbelfabrik Seon AG, Aarauerstrasse 4,
 5703 Seon
 Designer: Pius Baumgartner, Seon; Hans Dössegger, Seon



Vita 1



Vita 2

Cl. 07-02 **131 635** 14.03.2005
 4 Design – Feuerstellen
 Hinterleger: ATTIKA FEUER AG, Brunnmatt 16, 6330 Cham
 Designer: Stefan Stauffacher, Zürich; Erwin Hauenstein,
 Hünenberg
 Vertreter: OK pat AG, 6300 Zug





Beton



Rohr



Stahl

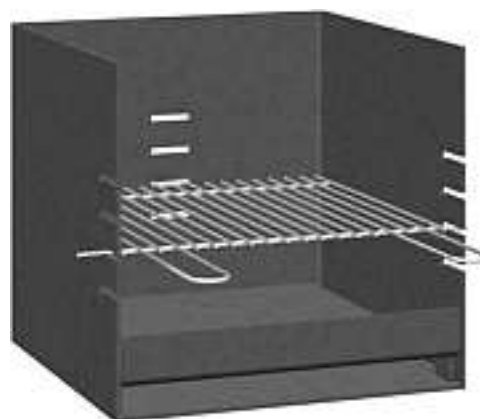

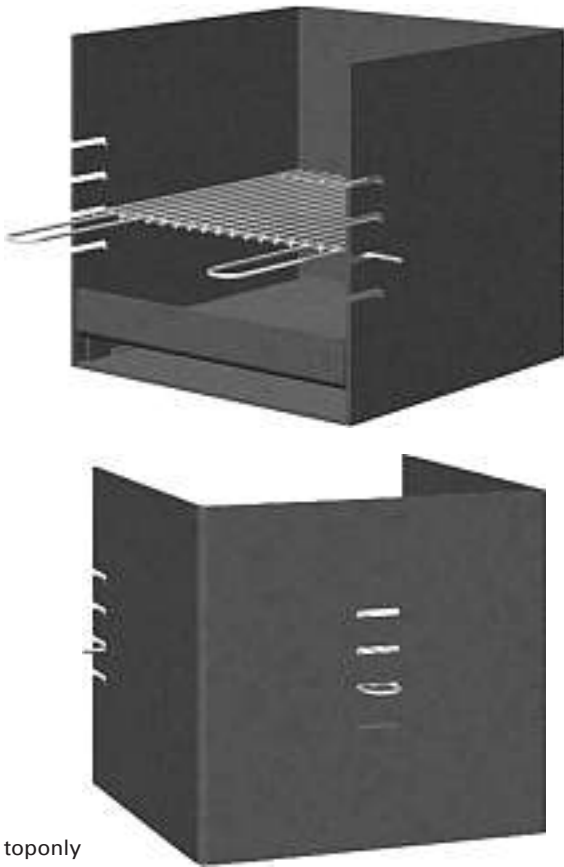

toponly

Cl. 07-04 **131 636** 09.03.2005
 2 Design – Fondue-Sieb
 Hinterleger: Traitements Thermiques S.A., Ile Falcon,
 3960 Sierre
 Designer: Thomas Bögli, Thun

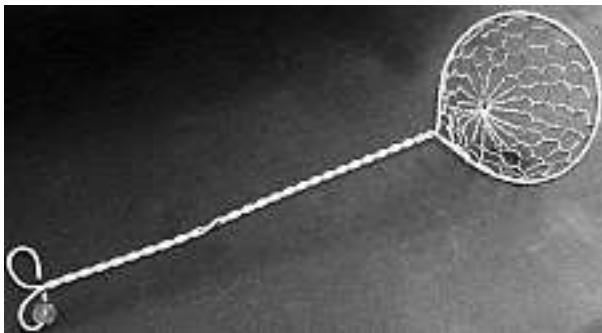

Fondue-Siebchen mit Farbmarkierung

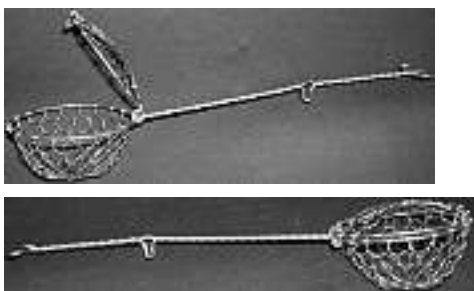

Fondue-Siebchen mit Deckel

Cl. 07-05 **131 637** 29.03.2005
 1 Design – Schwamm
 Hinterleger: Livio Altorfer, obere Haldenstrasse 4, 8196 Wil
 ZH



001

Cl. 07-99 **131 638** 15.03.2005

1 Design – Servierplateau
 Hinterleger: Dine & Drink GmbH, St. Gallerstrasse 68,
 9325 Roggwil TG
 Designer: Thomas Oetjen, Aadorf





Sombrero Fiesta

Cl. 07-99 **131 639** 22.03.2005
 4 Design – Trichter und Halter für Trichter
 Hinterleger: Pi-Design AG, Kantonsstrasse 100,
 6234 Triengen
 Designer: Jorgen Bodum, St. Niklausen
 Vertreter: Isler & Pedrazzini AG, 8023 Zürich
 Priorität: DK, 01.10.2004



1

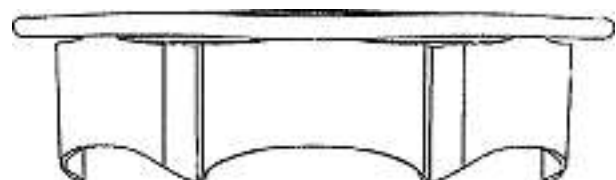
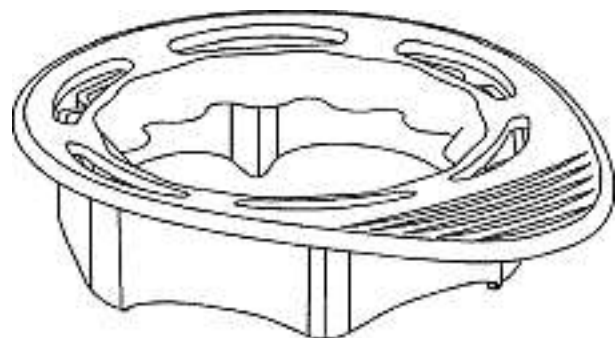

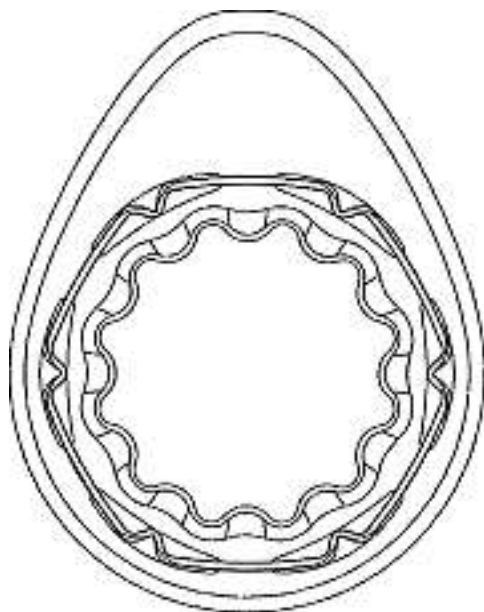
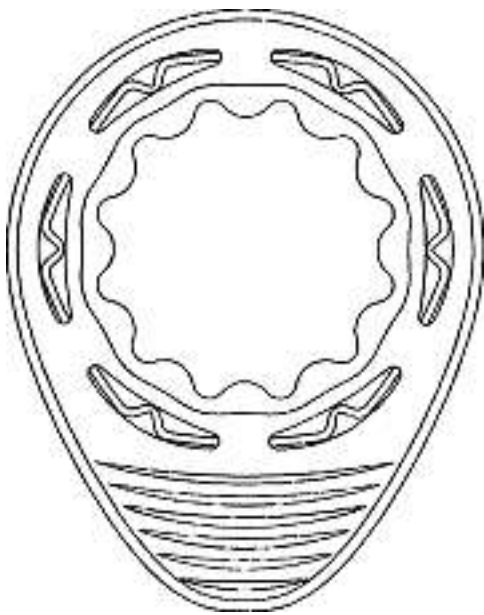
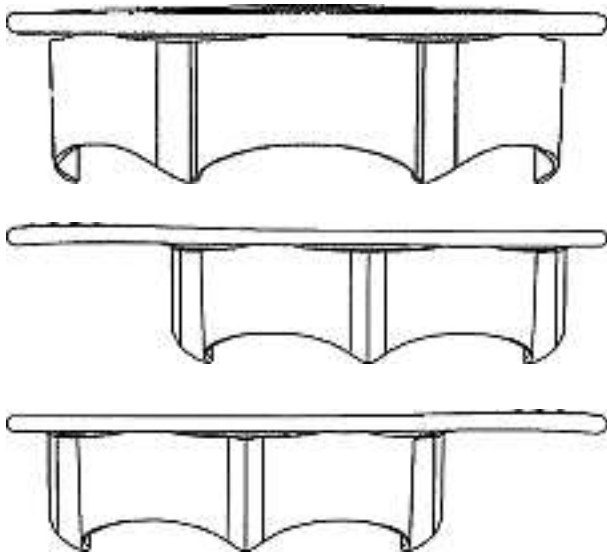



3

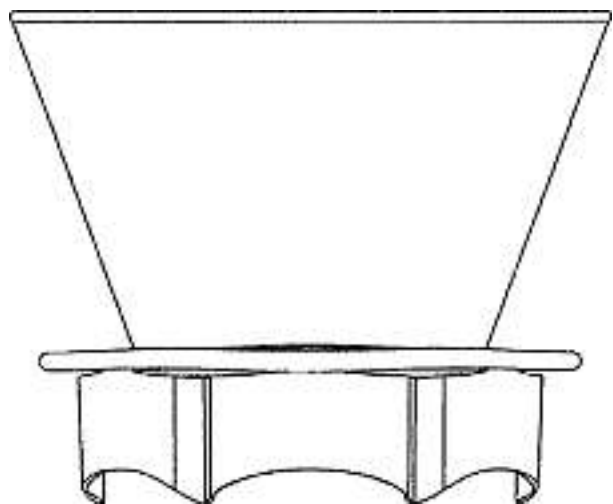
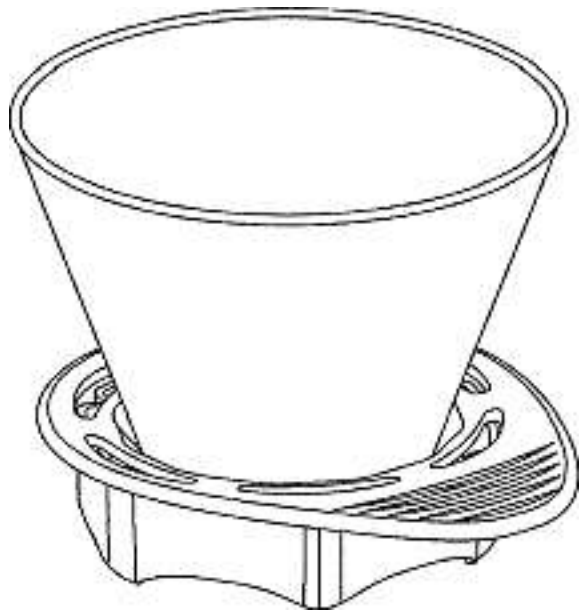

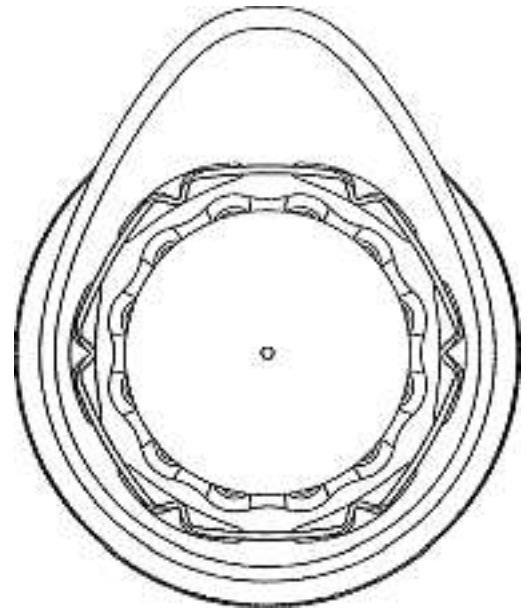
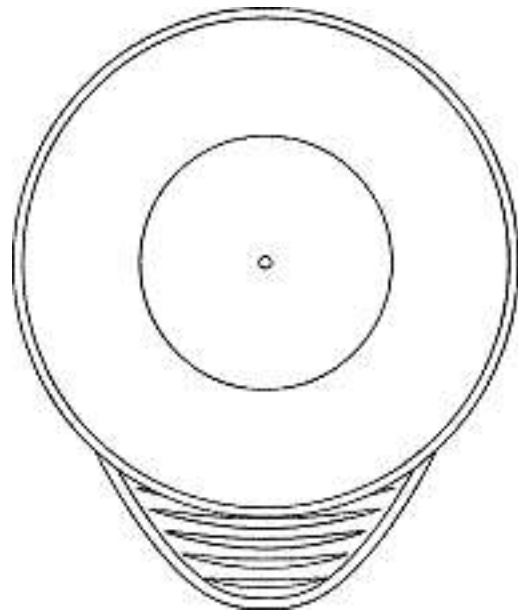
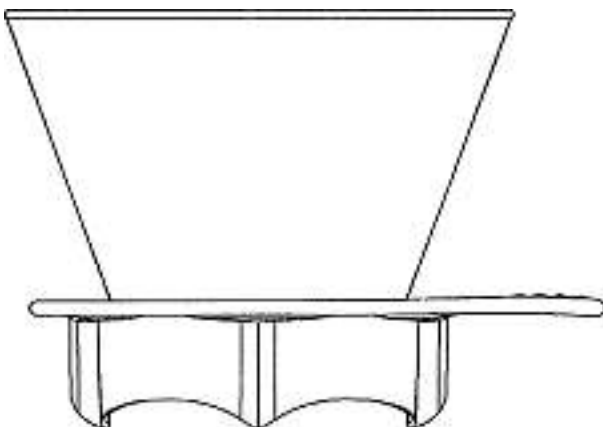
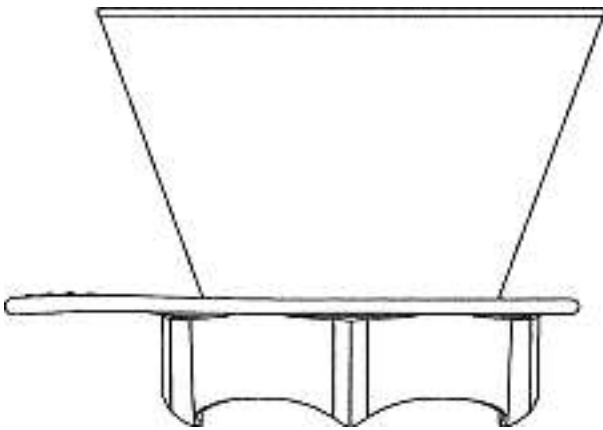
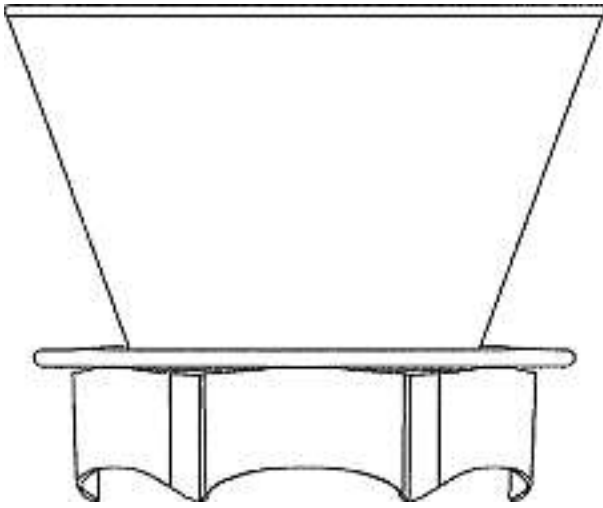

4

Cl. 09-01 **131 640** 10.03.2005
1 design – flacon
Déposant: PDP PARFUMS DE PARIS SA, Alte
Steinhauserstrasse 1, 6330 Cham
Designer: Thierry de Baschmakoff, Paris
Mandataire: Bugnion S.A., 1211 Genève 12 - Champel



1

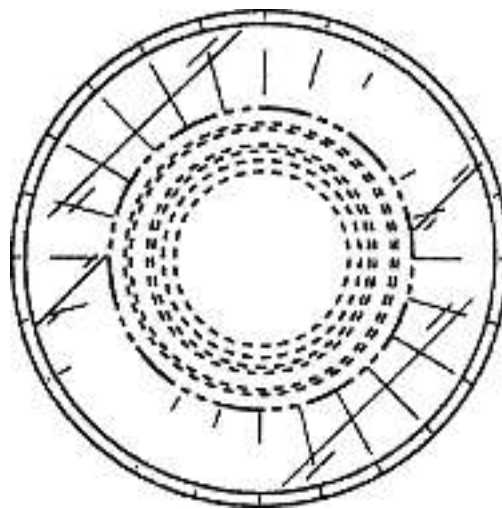
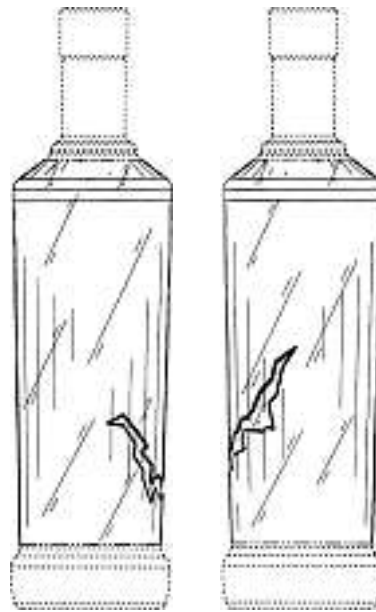

Cl. 09-01 131 641 24.03.2005
 4 Design – Flaschen
 Hinterleger: Diageo North America, Inc., 801 Main Avenue,
 Norwalk / CT, US
 Designer: Matthew Scott, New York; Jamie Foss, London
 Vertreter: Lenz & Staehelin, Rechtsanwälte, 8027 Zürich

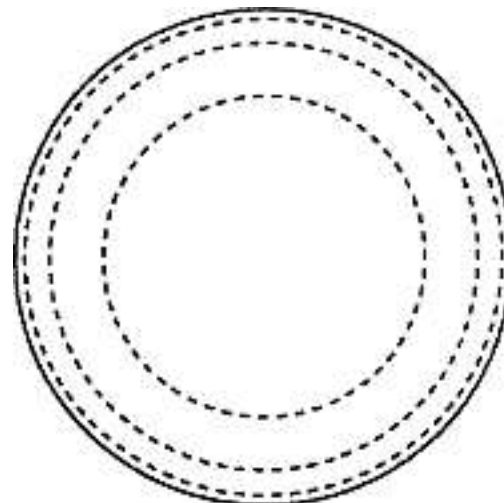
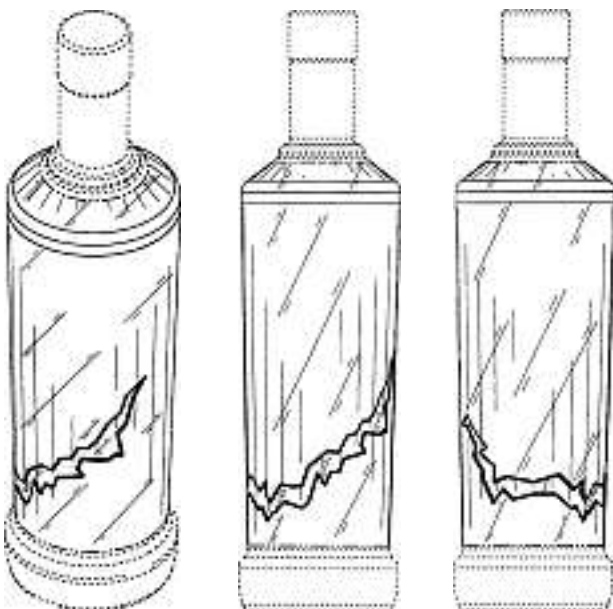

0704-DES/CH

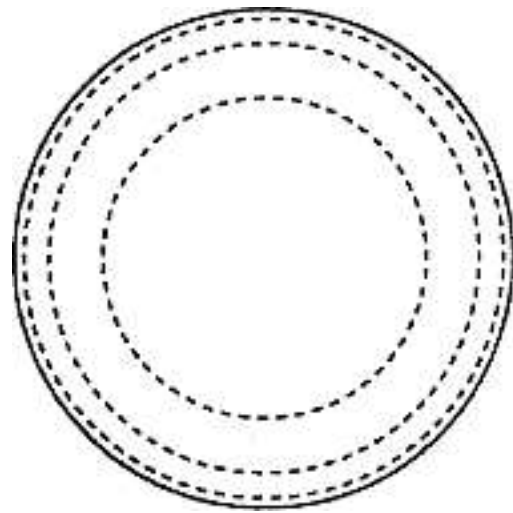
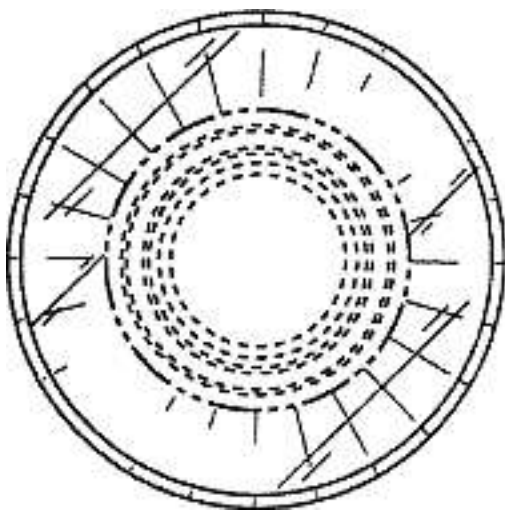
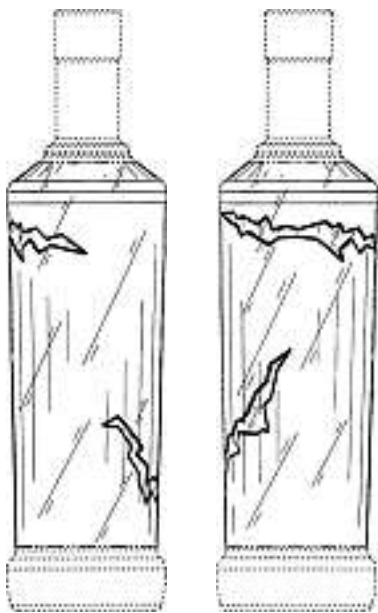
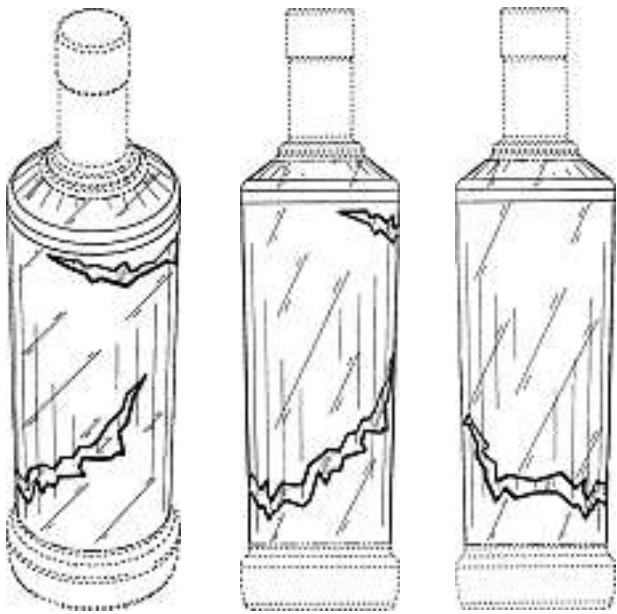

0708-DES/CH

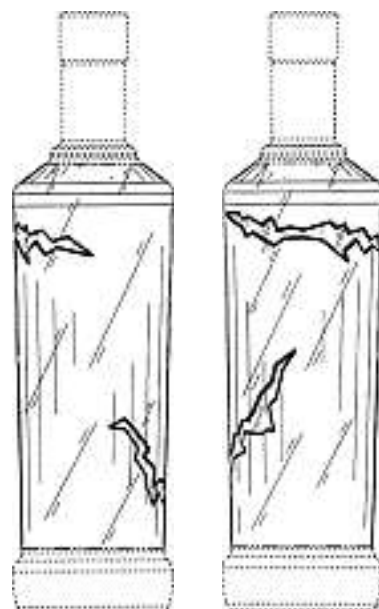
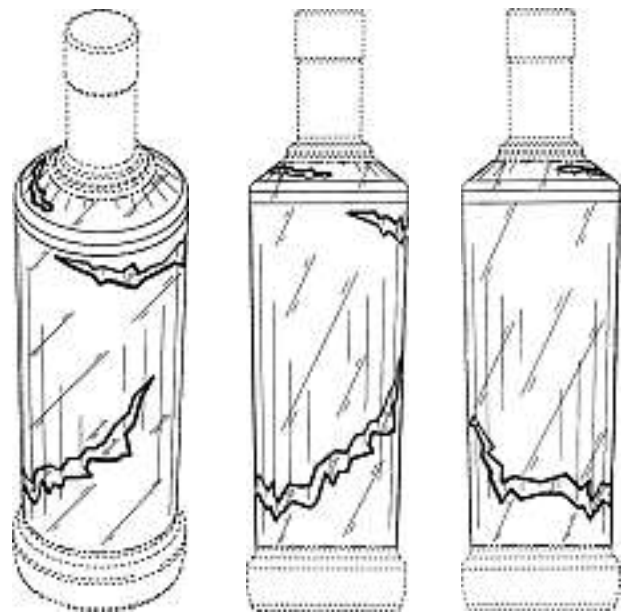

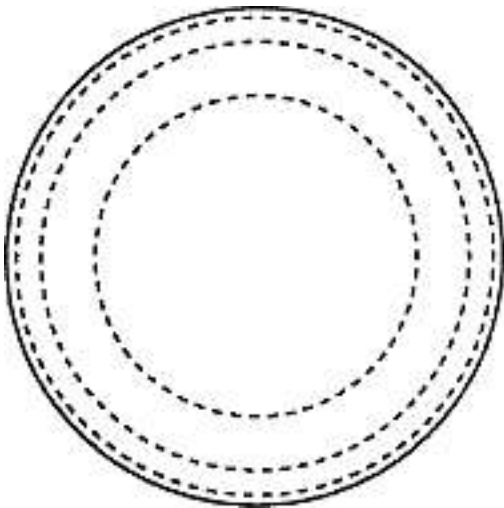
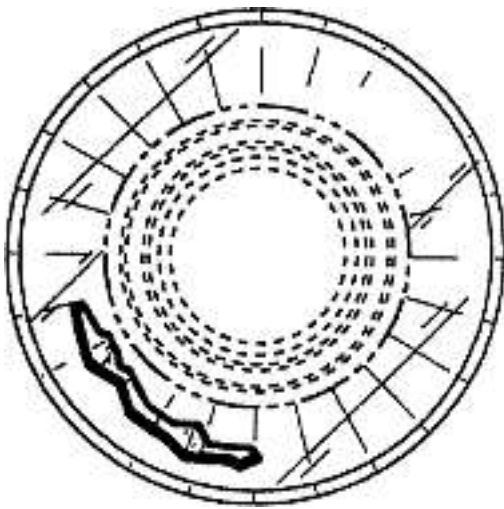

0708-DES/CHb

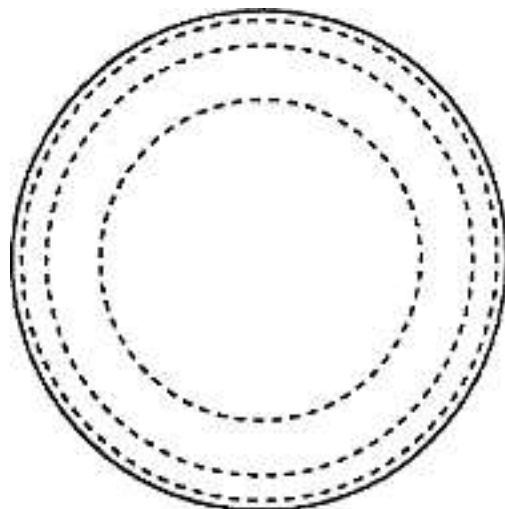
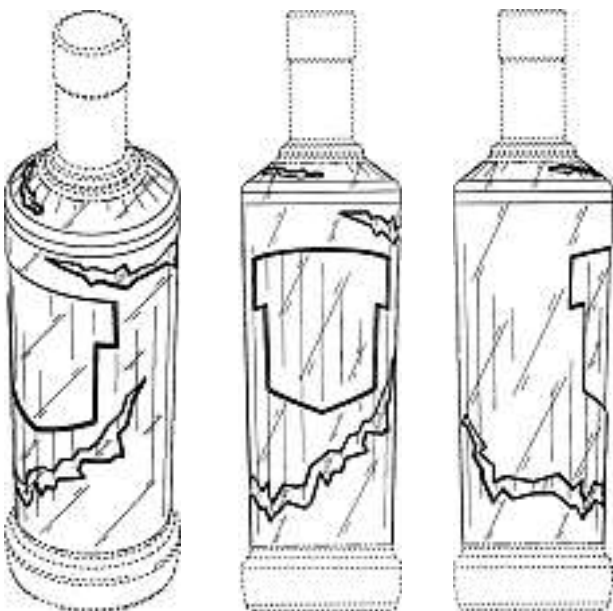
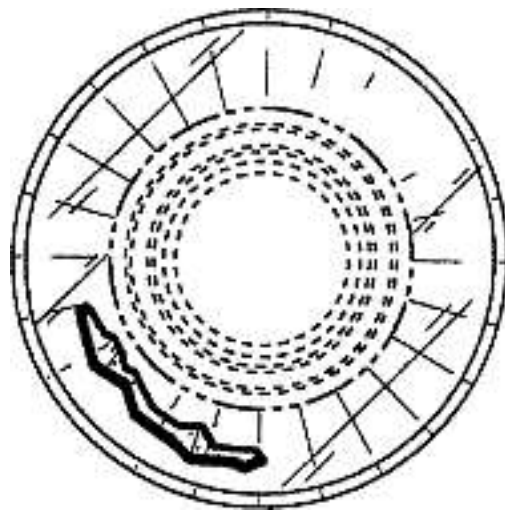
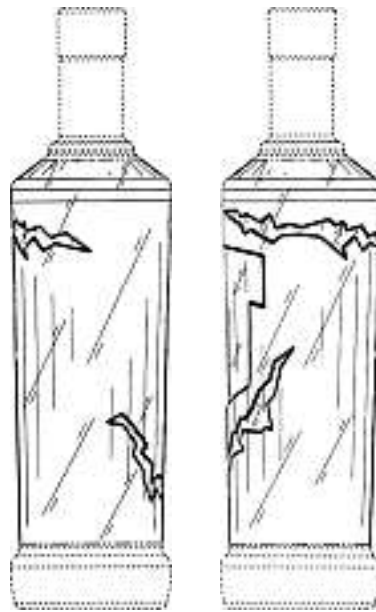

0709-DES/CH

Cl. 09-01 131 642 30.03.2005
1 design – emballage pour produits alimentaires
Déposant: Société des Produits Nestlé SA, 1800 Vevey
Designer: Damian Constantin, Prévèrenge; Christian Jehli, Freienbach
Mandataire: Nestec S.A., 1800 Vevey

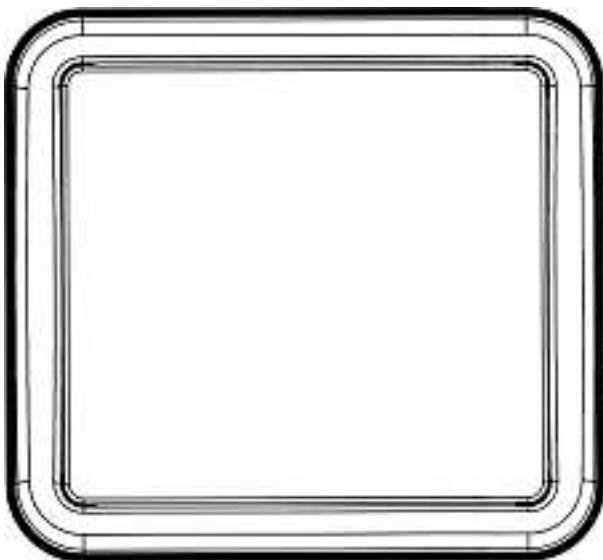
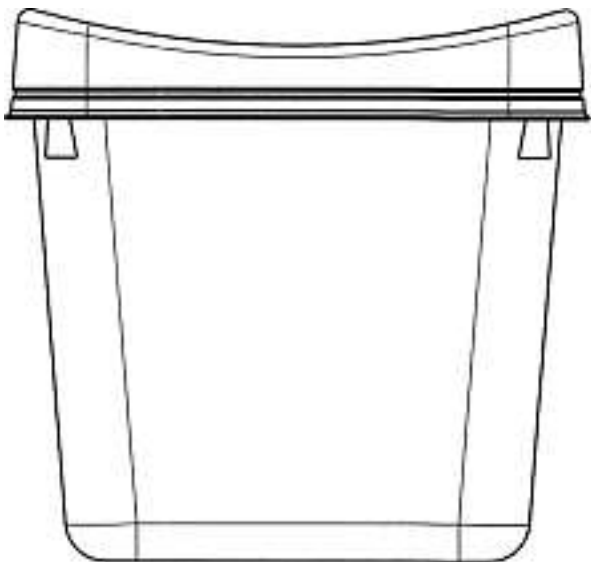
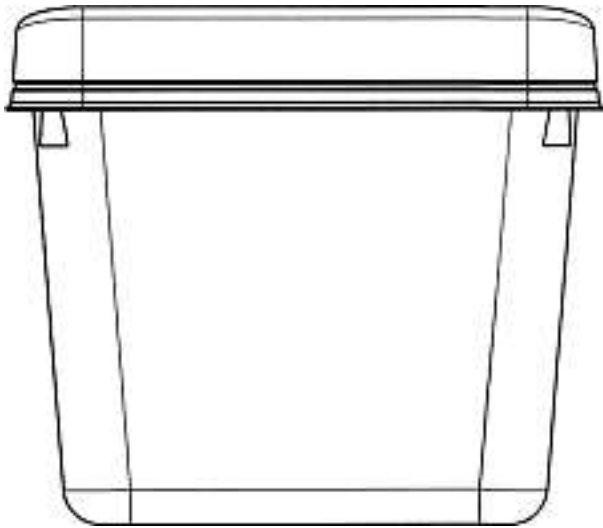

FL 57235

Cl. 09-03 131 643 29.03.2005
 1 Design – Verpackungsbehälter für Nahrungsmittel
 Hinterleger: Alcan Technology & Management Ltd., Badische
 Bahnhofstrasse 16, 8212 Neuhausen am Rheinfall
 Designer: Arjon Middelbrink, Twello
 Priorität: EM, 15.12.2004

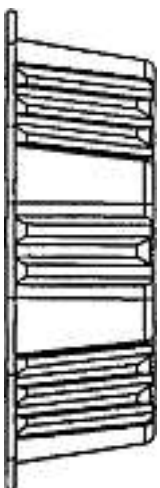
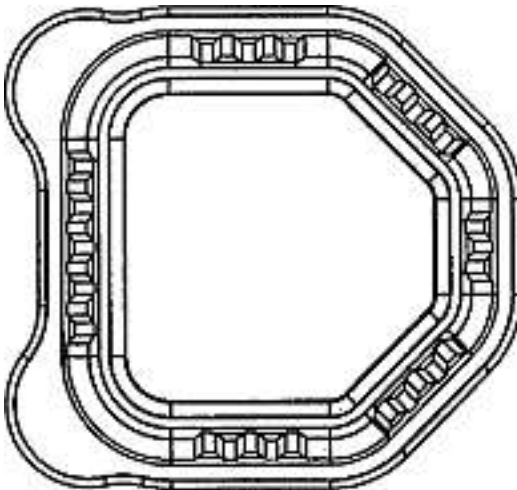
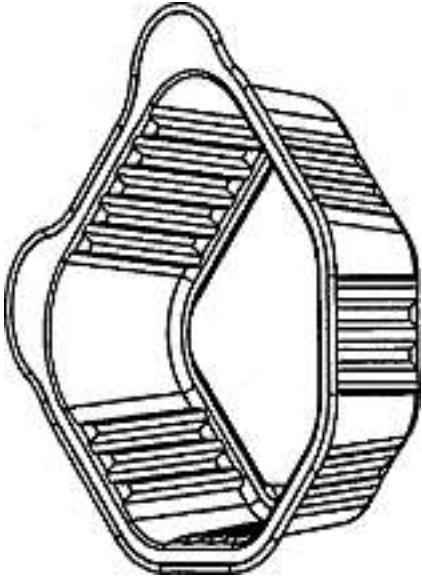
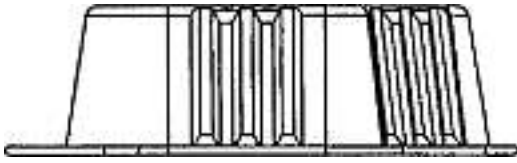

IR6384CH

Cl. 09-05 131 644 15.03.2005
 6 design – dessins pour emballages
 Déposant: PICUS GENEVE S.A., 5, rond-point de Plainpalais,
 case postale 318, 1211 Genève 4
 Designer: Catherine Portier, Plan-les-Ouates



2005001



2005002



2005003



2005004



2005005



2005006



974 Inspiration



985 Inspiration



993 Inspiration

Cl. 10-02 131 645 27.01.2005
3 Design – Armband-Uhren
Hinterleger: Jacqueline Urbach, Aeschholzstrasse 7,
8127 Forch

Cl. 10-02 131 646 24.03.2005
 4 Design – Armbanduhr
 Hinterleger: Festina Lotus S.A., Via Layetana, 20-4a,
 Barcelona, ES
 Designer: Miguel Rodriguez, Barcelona
 Vertreter: Schmauder & Partner AG, Patentanwälte VSP,
 8038 Zürich
 Priorität: EM, 28.01.2005

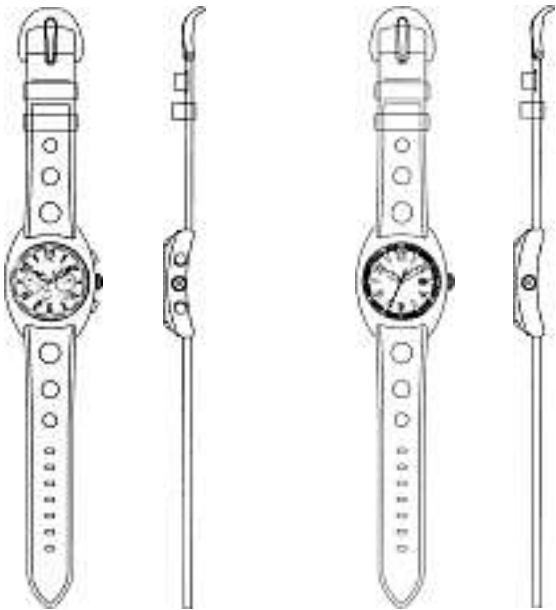

1

2



3



4

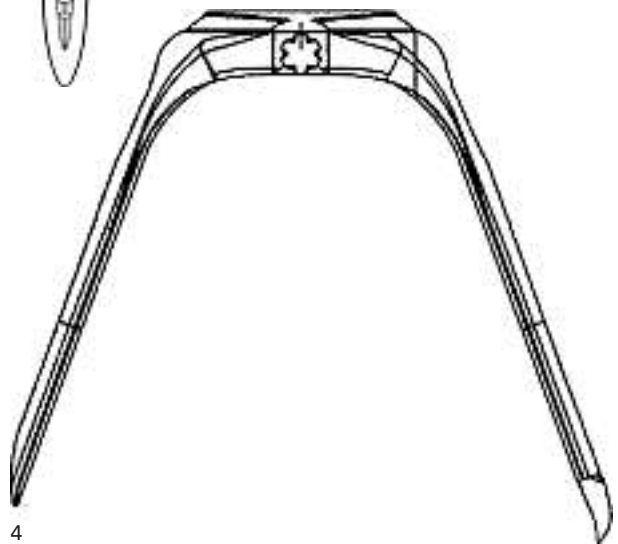

Cl. 10-02 131 647 24.03.2005
 3 design – montres
 Déposant: Sarcar Tramex SA, 41a, route de Chêne,
 1208 Genève
 Designer: Claude Toniutti, Arthaz Pont Notre Dame
 Mandataire: Bugnion S.A., 1211 Genève 12 - Champel



No 1



No 2



No 3

Cl. 10-02 **131 648** 29.03.2005
 1 design – montre-bracelet
 Déposant: PMH Production et Marketing Horloger SA,
 chemin des Tourelles 4, 2400 Le Locle
 Designer: Antoine Tschumi, Le Locle
 Mandataire: INFOSUISSE, Information Horlogère et
 Industrielle, 2302 La Chaux-de-Fonds



1

Cl. 10-07 **131 652** 22.03.2005
 12 design – montres, boîtes de montres et cadrans
 Déposant: ROLEX SA, rue François-Dussaud 3-5-7,
 1211 Genève 26
 Designer: Maria Cristina Calvani, Cologny
 Mandataire: Bugnion S.A., 1211 Genève 12 Champel

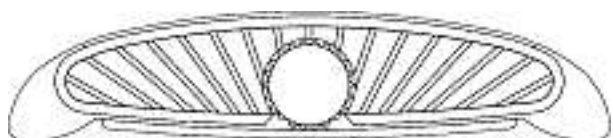
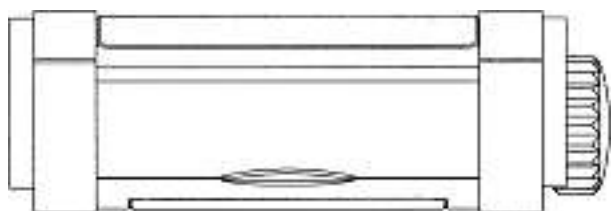
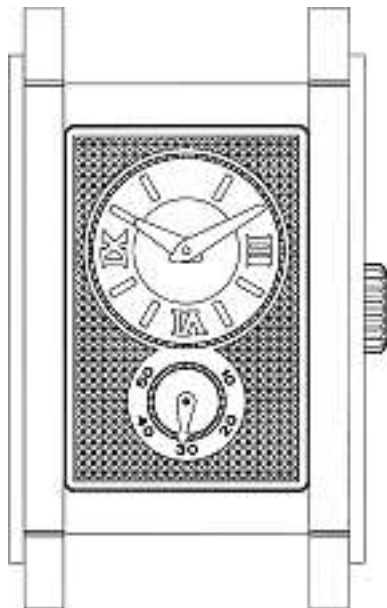

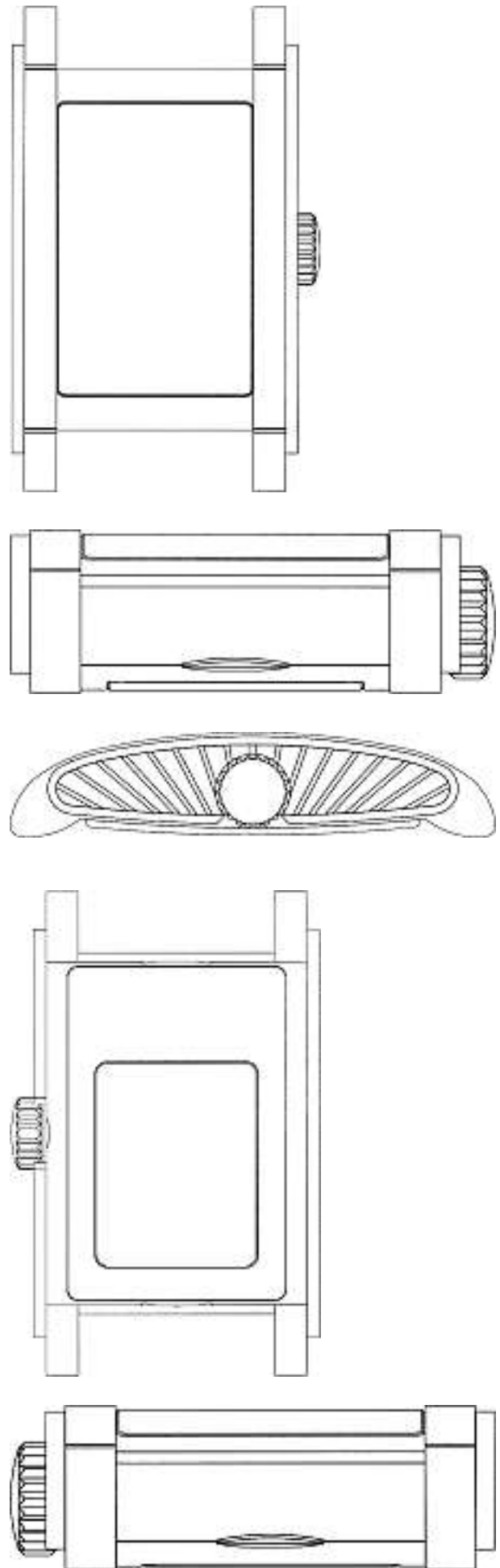
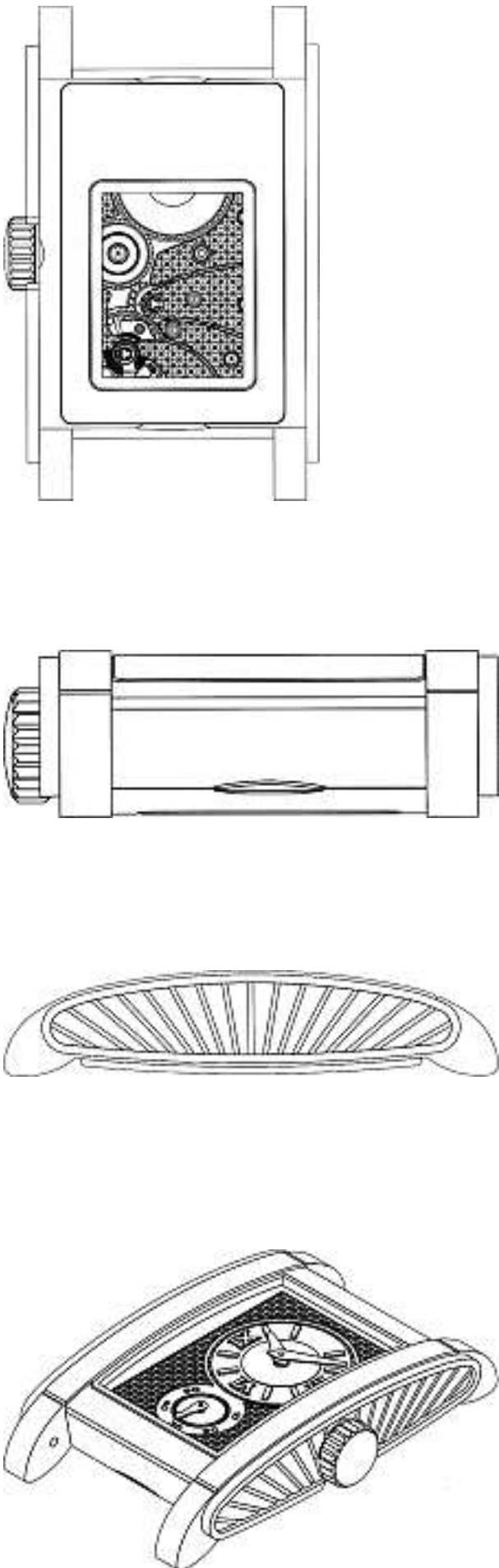

No 1

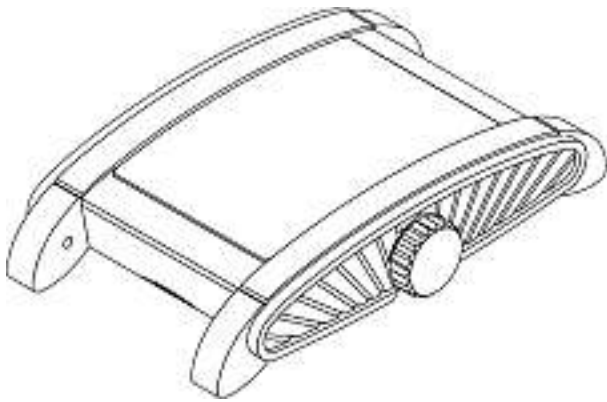
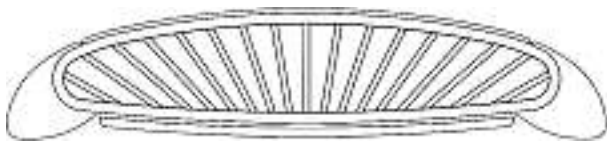

No 2

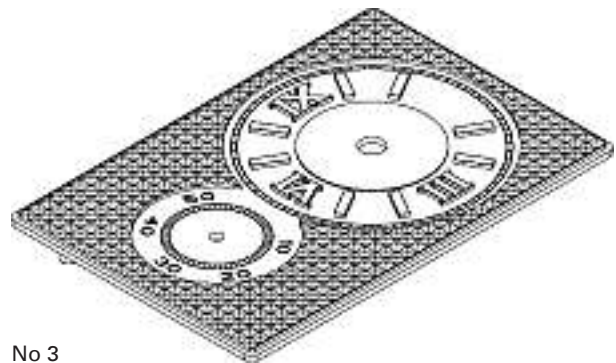
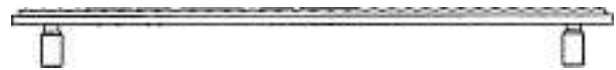
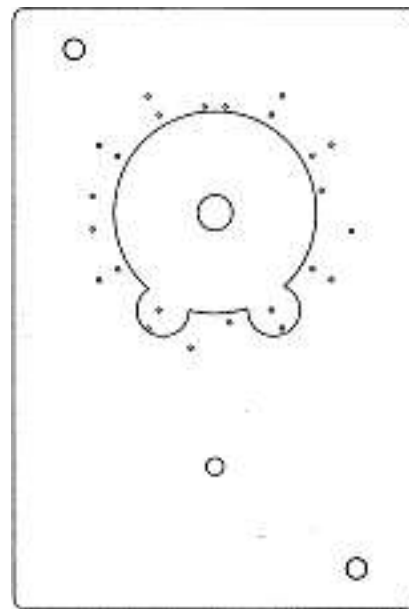
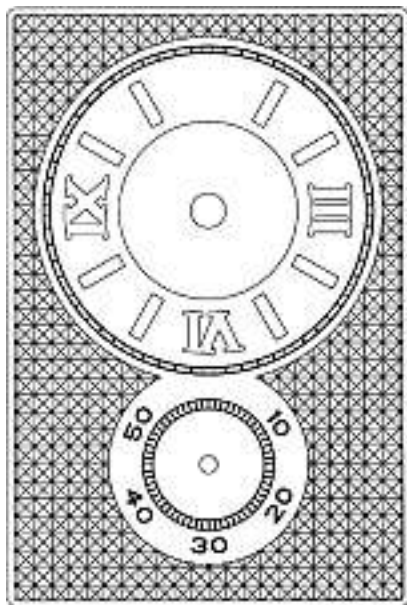

No 3

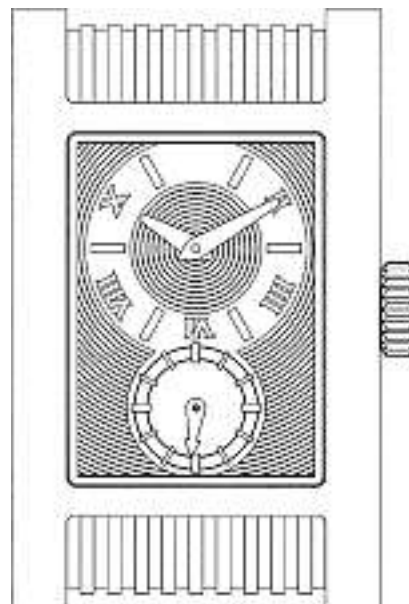

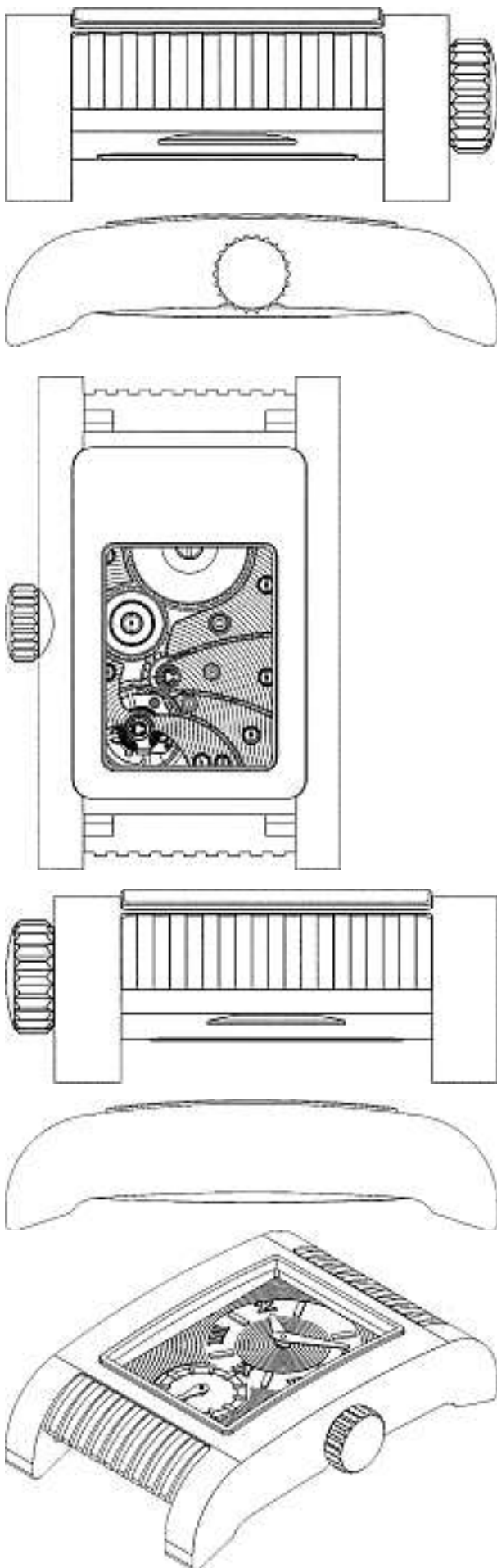

No 4

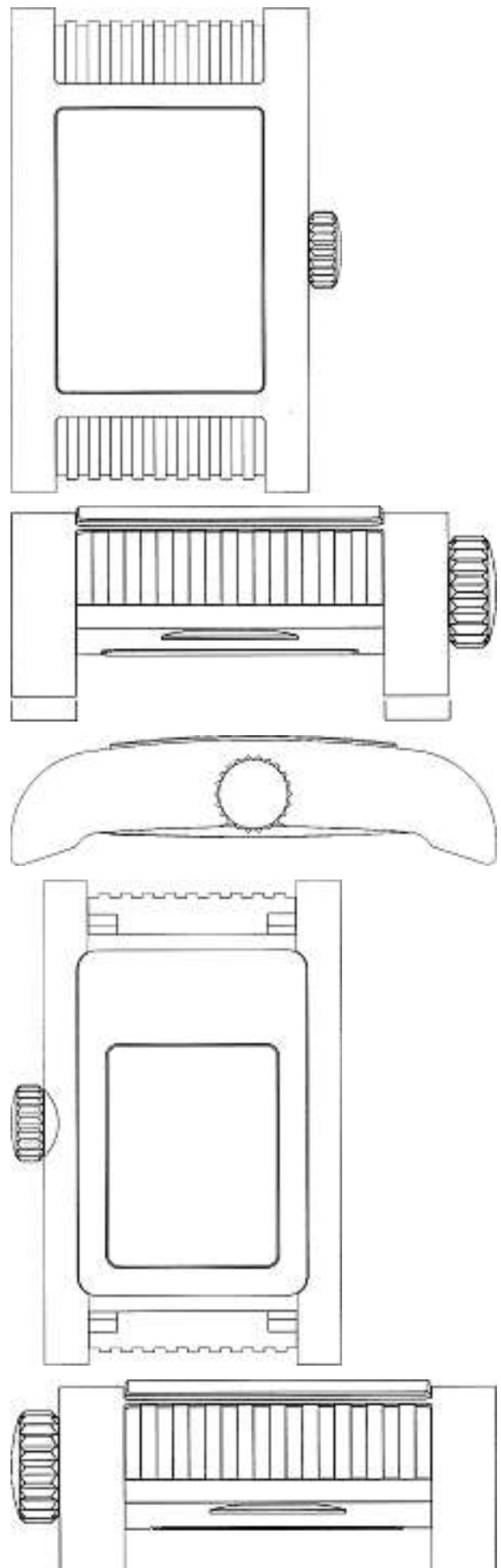



No 5

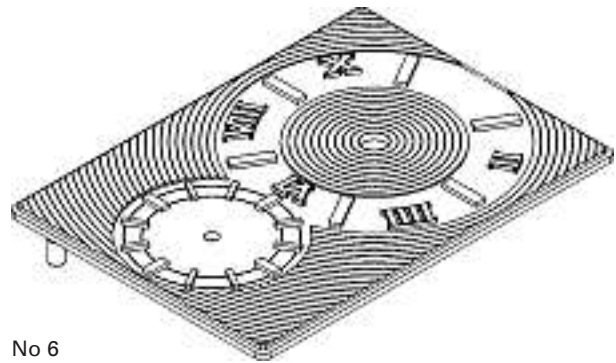
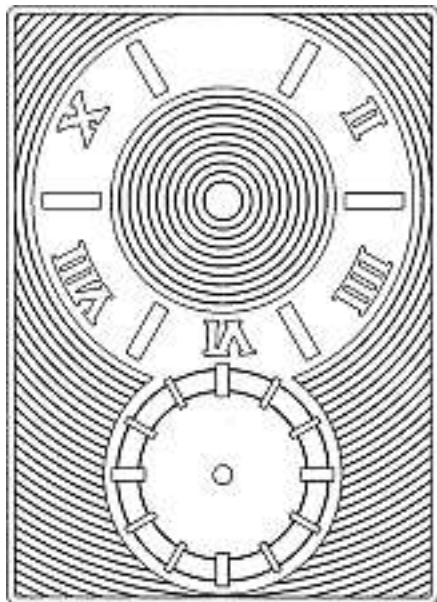
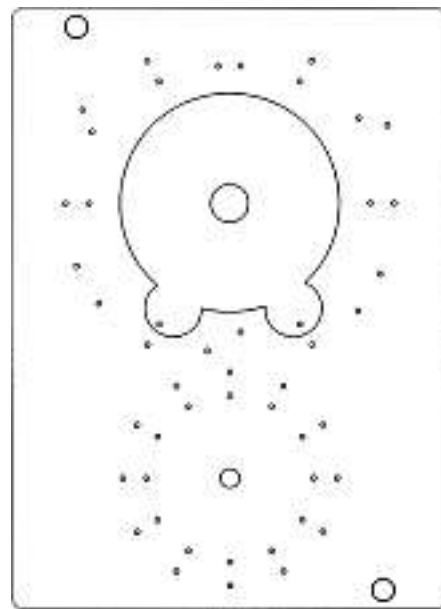

No 6

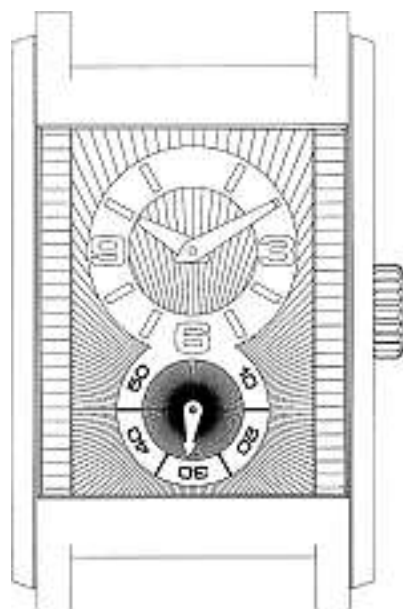

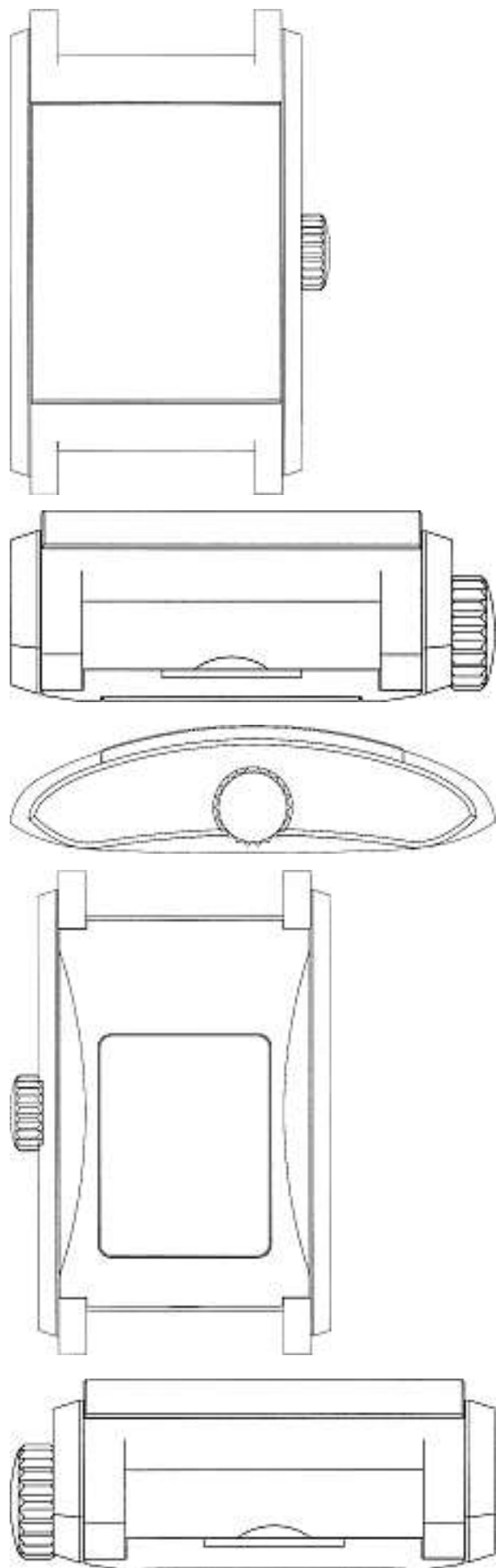
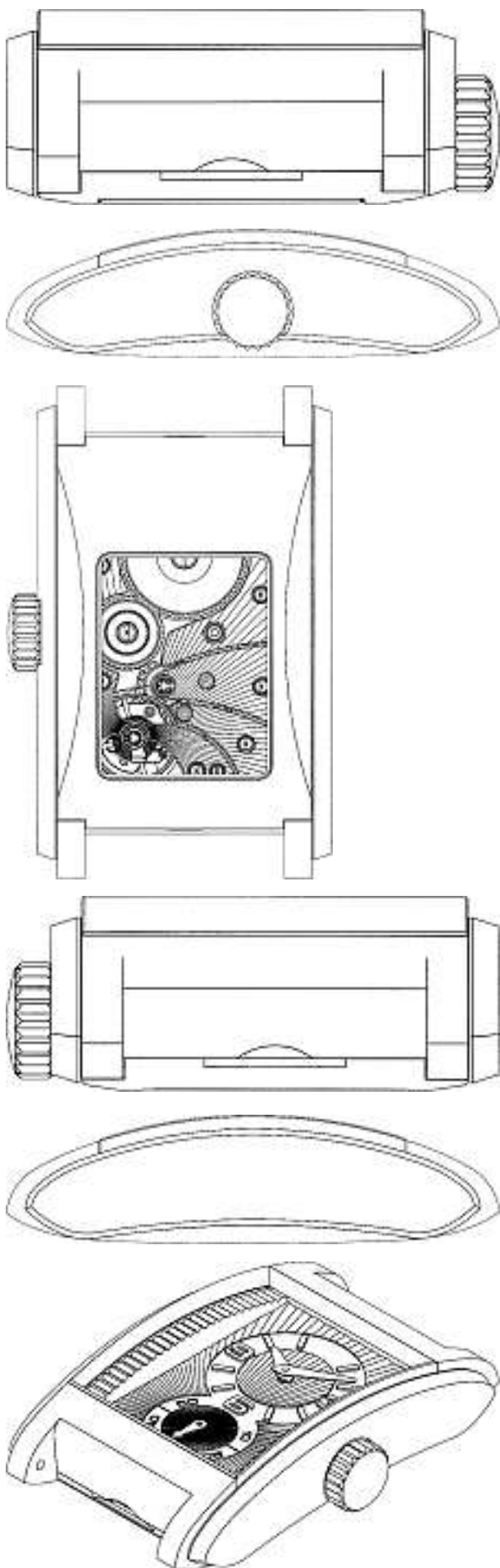

No 7

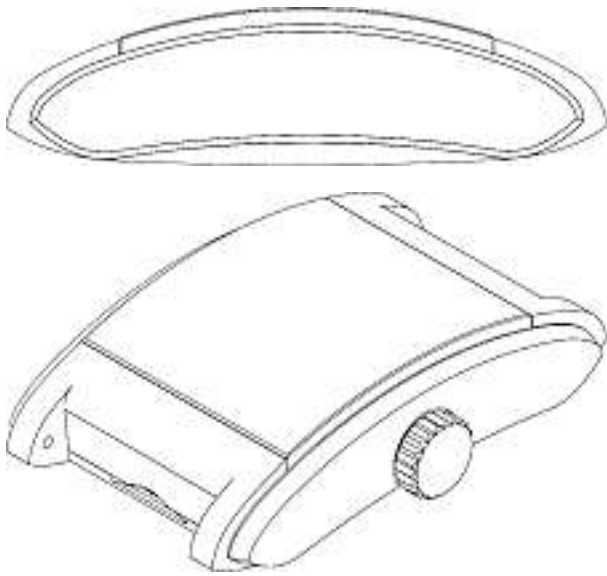

No 8

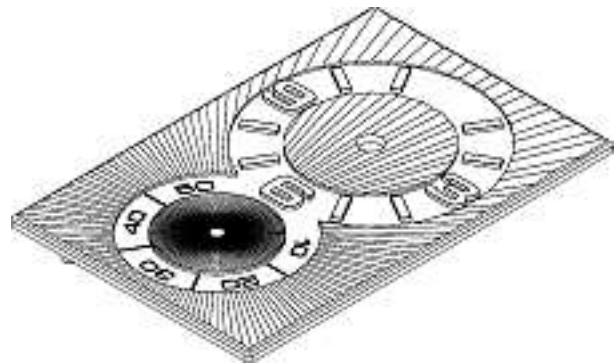
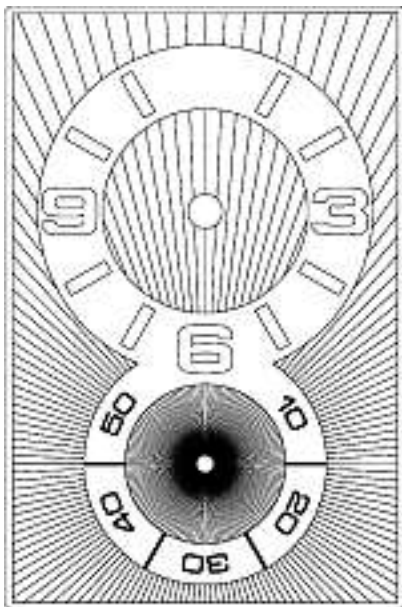
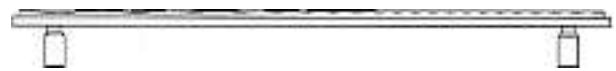
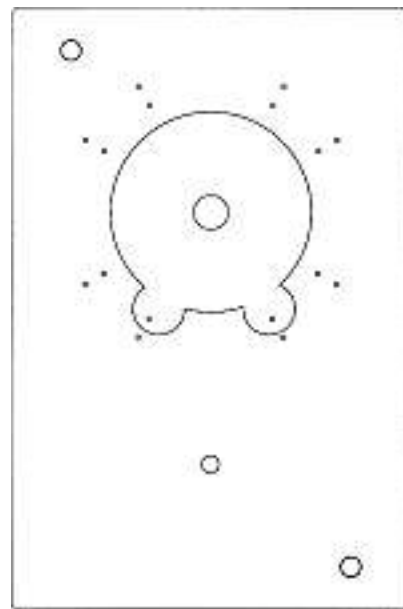

No 9

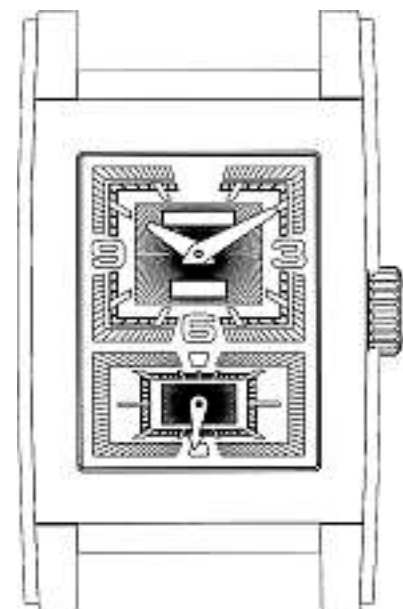

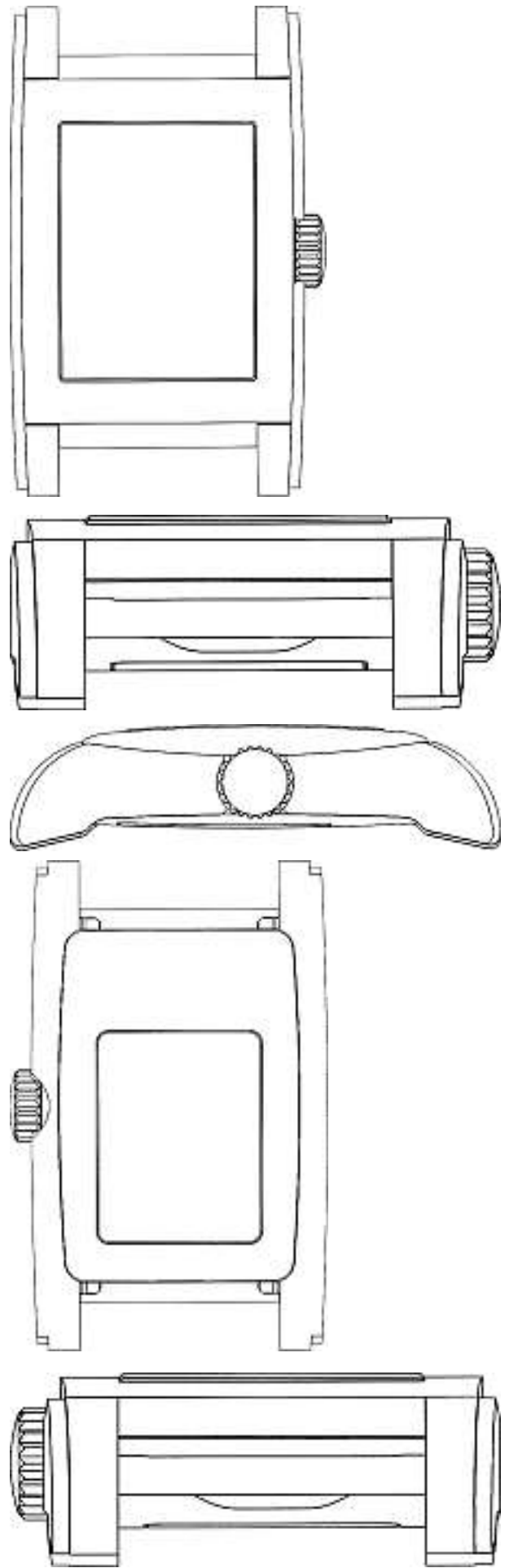
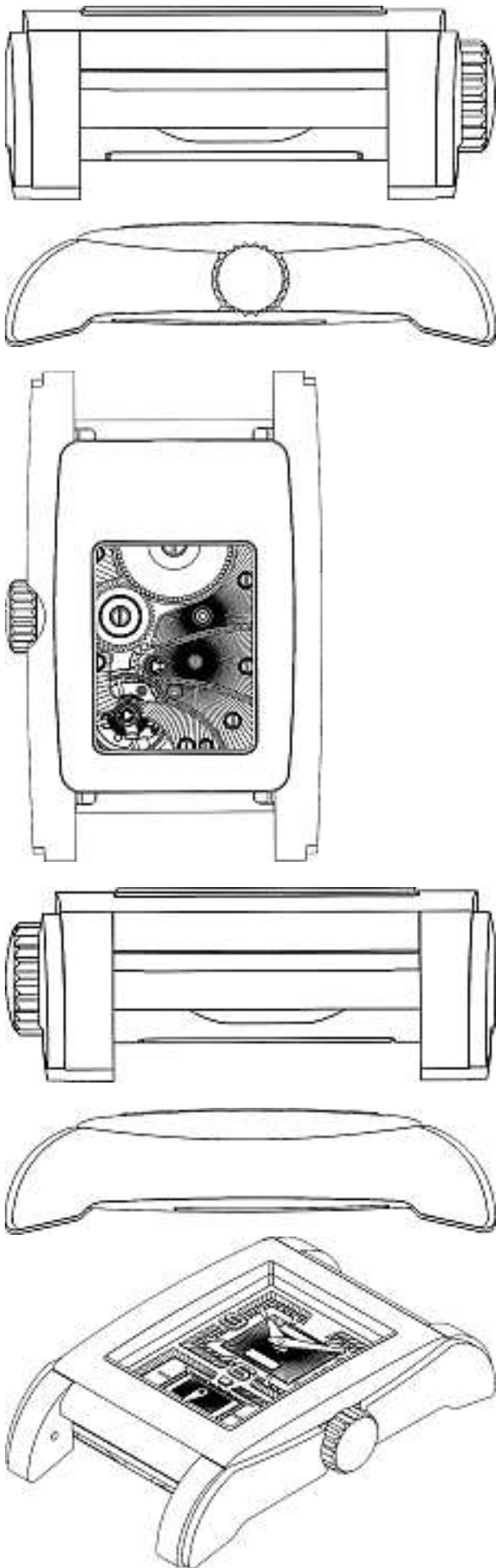

No 10



No 11

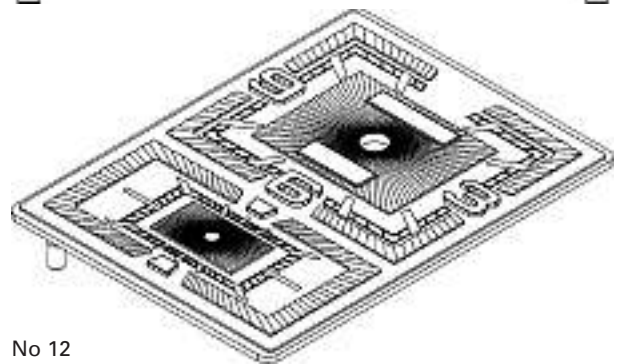
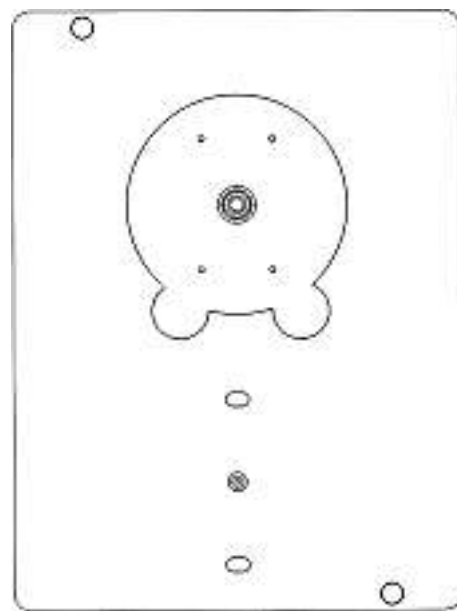
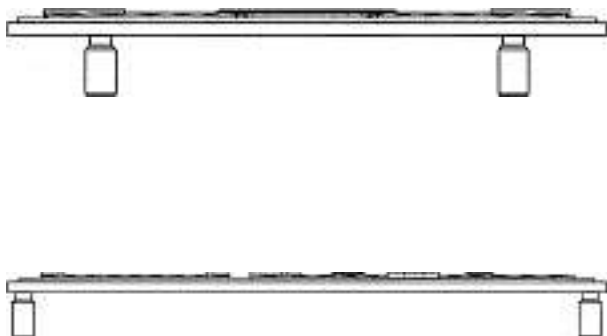
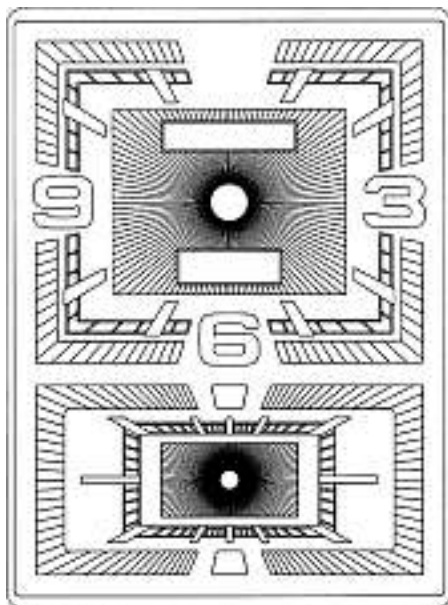

No 12

Cl. 10-07 **131 653** 24.03.2005
 1 design – fermoir de bracelet montre
 Déposant: Faat Wai Lai, Block K,L, 17/F, Stage 4, Golden Dragon Industrial Centre 182-190, Tai Lin Pai Road, Kwai Chung, New Territories, HK
 Mandataire: Bugnion S.A., 1211 Genève 12 - Champel

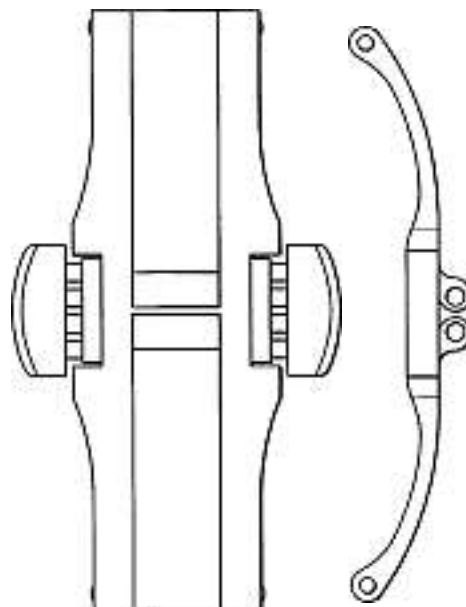

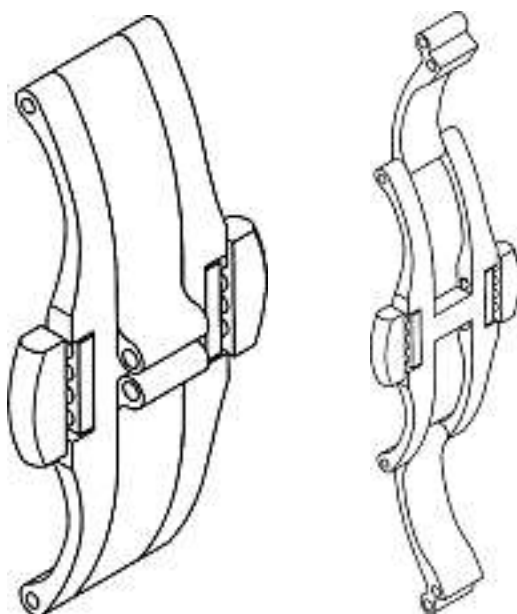
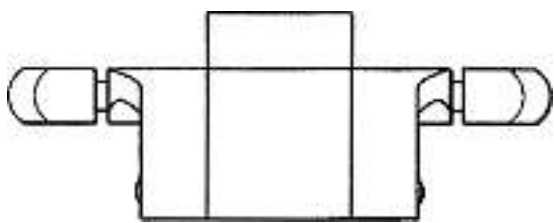
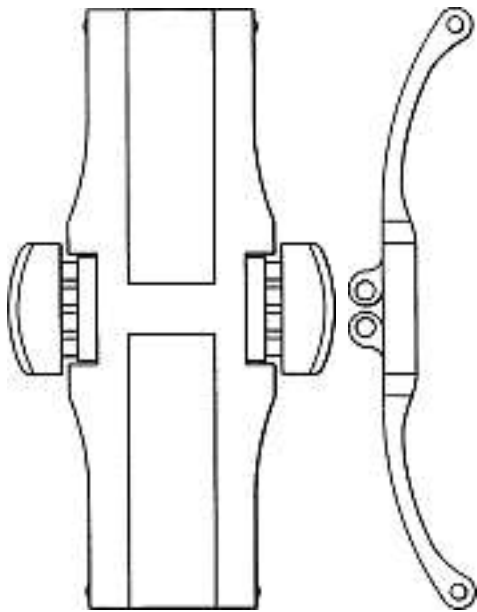
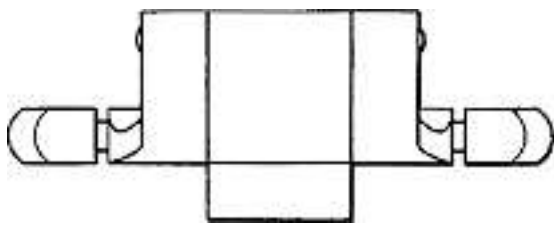

No 1

Cl. 11-01 131 656 11.03.2005

4 Design – Fingerringe

Hinterleger: Luis Novoa, Finkenweg 10, 2557 Studen

Vertreter: Ammann Patentanwälte AG Bern, 3001 Bern

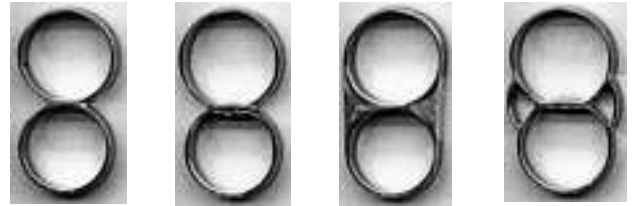

1

2

3

4

Cl. 11-01 131 657 18.03.2005

1 design – pendentif

Déposant: Chaumet International S.A., 12, Place Vendôme, 75001 Paris, FR

Designer: Thierry Fritsch, Paris

Mandataire: Griffes Consulting S.A., 1206 Genève

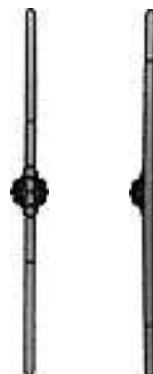

MO-69424-CH

Cl. 11-02 131 658 13.04.2005
7 Design – Pflanzenschale
Hinterleger: MEGA-GLAS, Alpenstrasse 4, 9479 Oberschan
Designer: Matthias Gabathuler, Oberschan

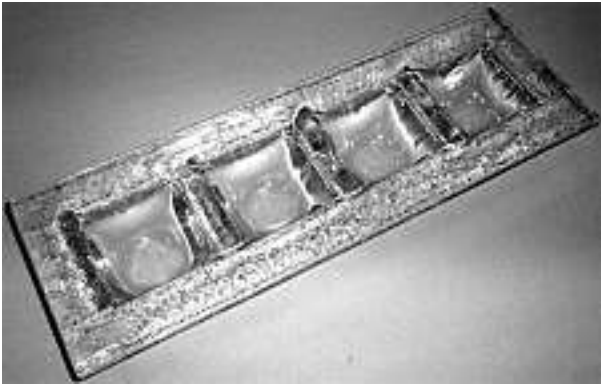

435.08

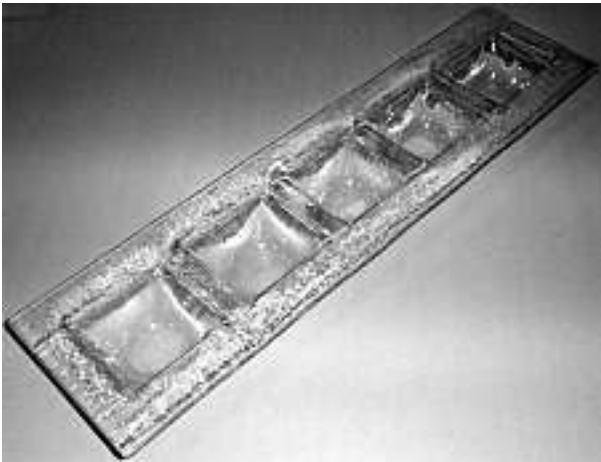

435.09

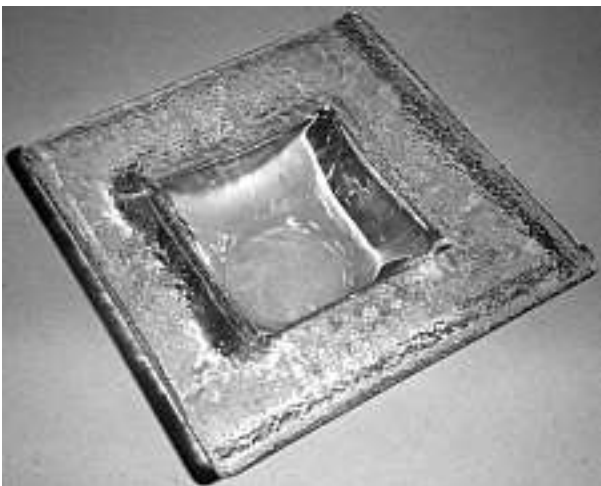

435.14

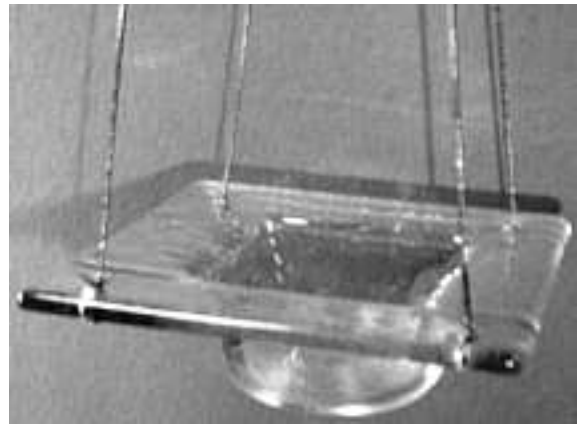

435.14 H



435.63



436.50



462.24

Cl. 11-05 131 659 25.02.2005
1 Design – Fahnenhalter
Hinterleger: Heinz Stengel, Löwenstrasse 2, Neumarkt, DE
Vertreter: Ursula Böker, 9435 Heerbrugg
Priorität: DE, 11.11.2004

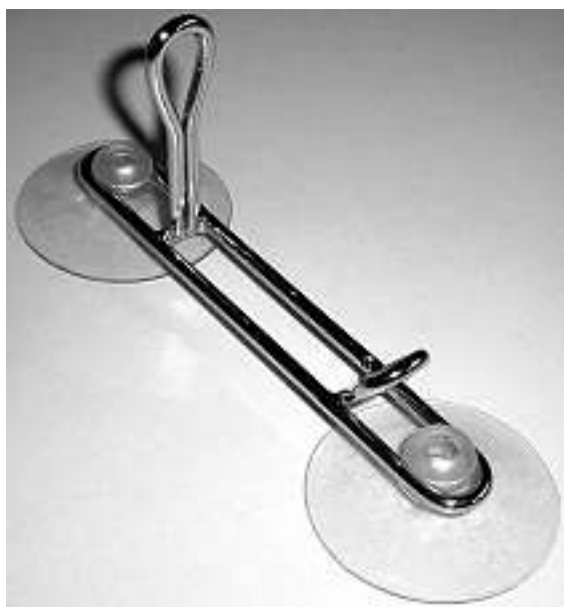

Fahren 11-05

Cl. 12-11 **131 660** 10.03.2005
 2 design – motoscooter ed una sua parte
 Depositante: Honda Motor Co., Ltd., No. 1-1, 2-chome,
 Minami-aoyama, Minato-ku, Tokyo, JP
 Designer: Teofilo Plaza, Roma; Lorenzo Palazzo, Roma;
 Valerio Aiello, Roma
 Mandatario: Fiammenghi-Fiammenghi, 6900 Lugano
 Priorità: JP, 30.09.2004





1





2

Cl. 12-14 131 661 17.03.2005
 1 Design – Schlitten
 Hinterleger: Pierre Messerli, Rte Principale 15 a,
 2747 Corcelles BE
 Vertreter: Felber & Partner AG, 8034 Zürich



1

Cl. 14-01 131 662 21.03.2005
 1 Design – Sprachnotizgerät
 Hinterleger: Bones GmbH, Alpenstrasse 2, 6300 Zug
 Designer: Stephan Knecht, Zürich; Stefan Küng, Horgen





B-67002, PAVIP Milestone 311

Cl. 14-99 **131 665** 23.03.2005

5 Design – Computerbildschirm-Halter und Anordnung von Computer-Bildschirmen

Hinterleger: Ernst Maurer, Höh, 3615 Heimenschwand
 Vertreter: Bovard AG, 3000 Bern 25

Beschreibung des Designs: Die Halter für einen bzw. zwei übereinander stehende Bildschirme sind reversibel; sie haben Lochreihen (mit Abdeckung) auf der geneigten und auch auf der fast senkrechten Ebene. Je nach gewünschter Anordnung mehrerer über- und/oder nebeneinander stehender Bildschirme werden die Halter gedreht und die Bildschirme wahlweise auf der schrägen oder senkrechten Seite eingehängt (und mittels Befestigungsvorrichtung in der gewünschten Position justiert).

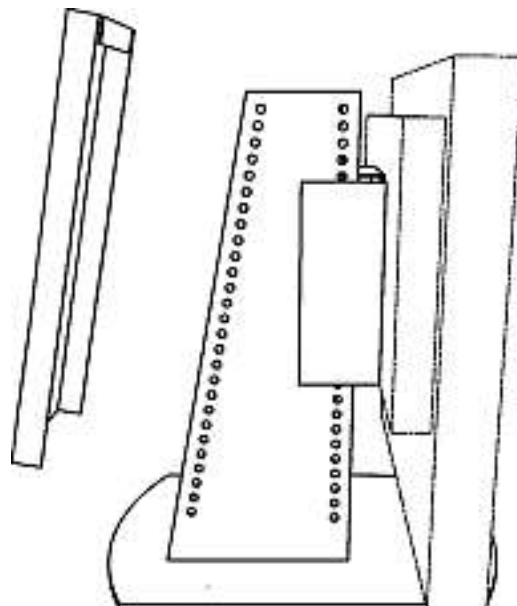
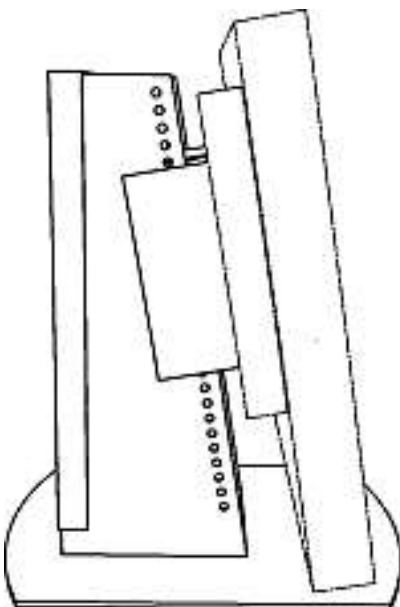
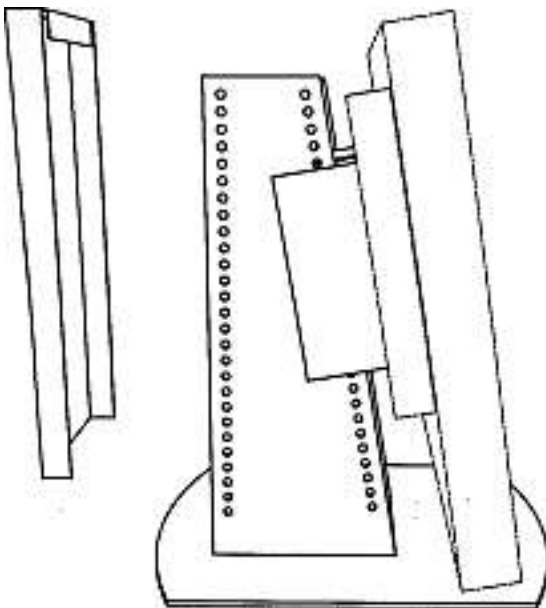
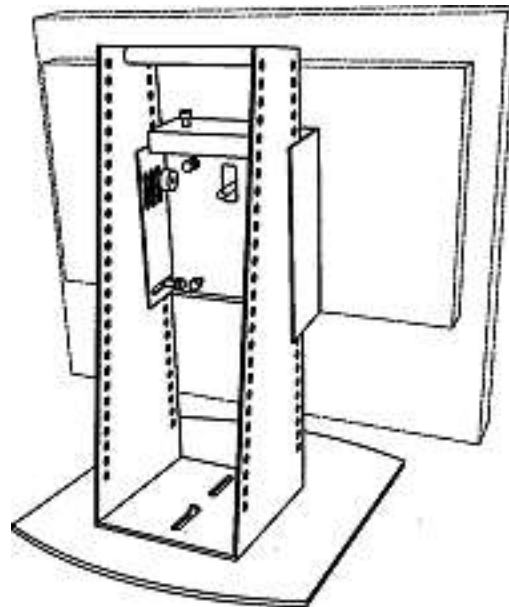
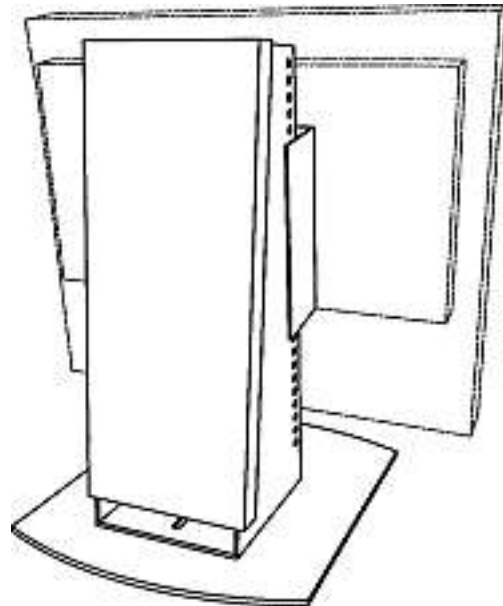

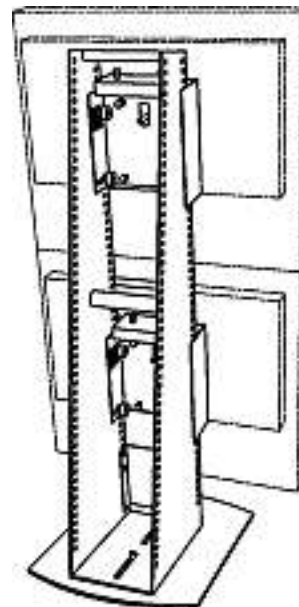
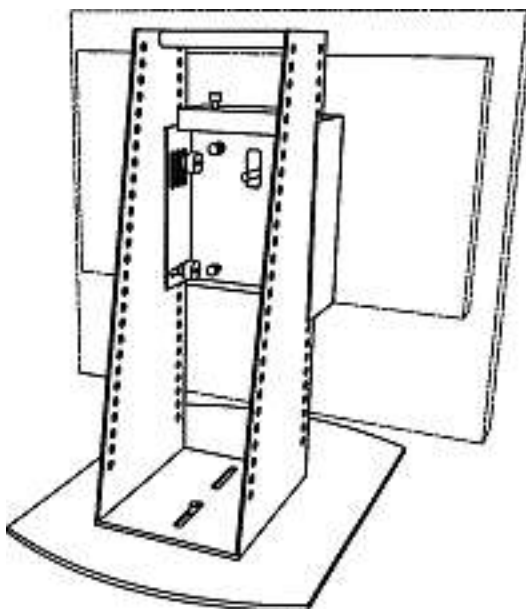
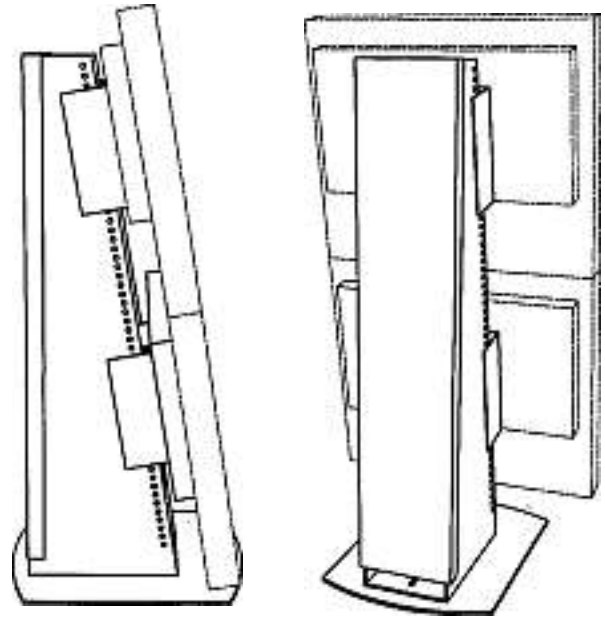
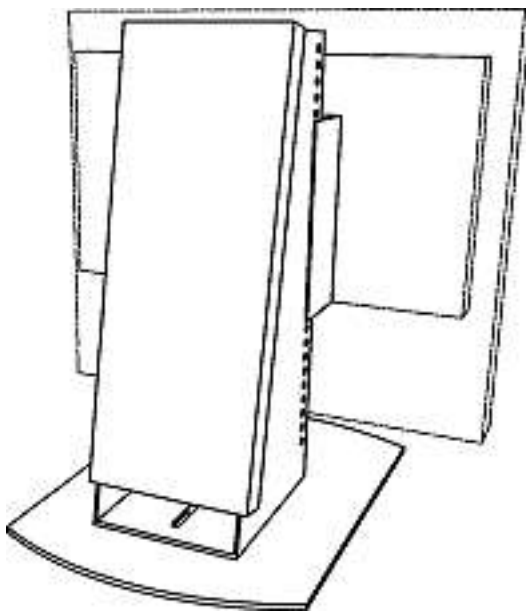
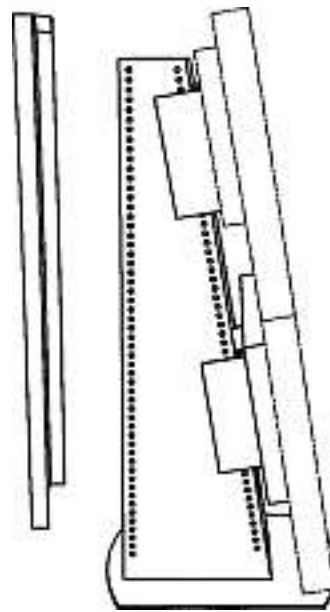
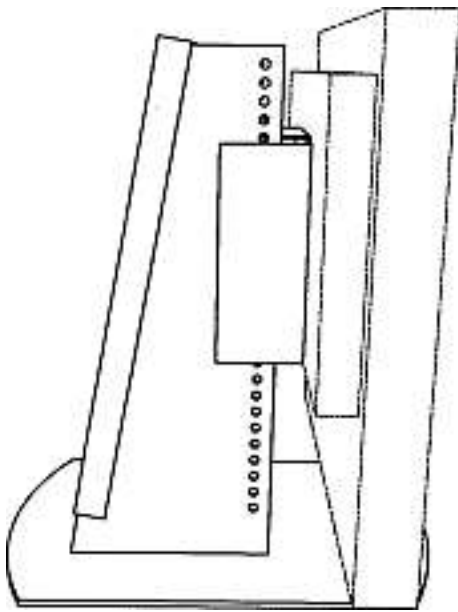

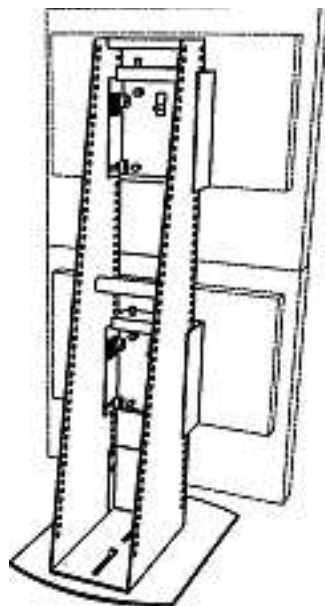
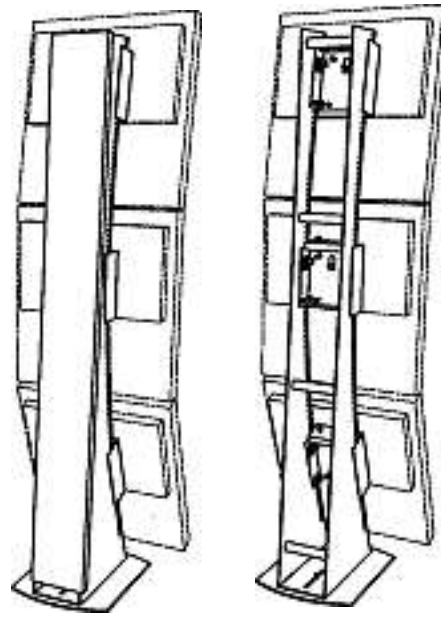
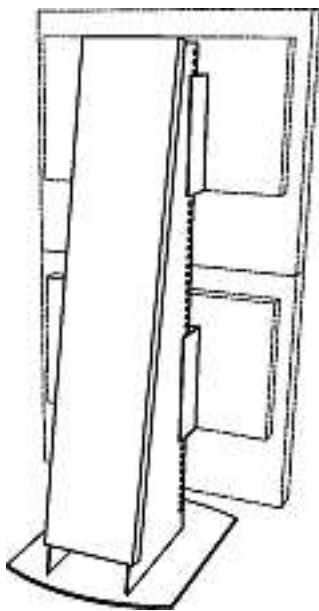
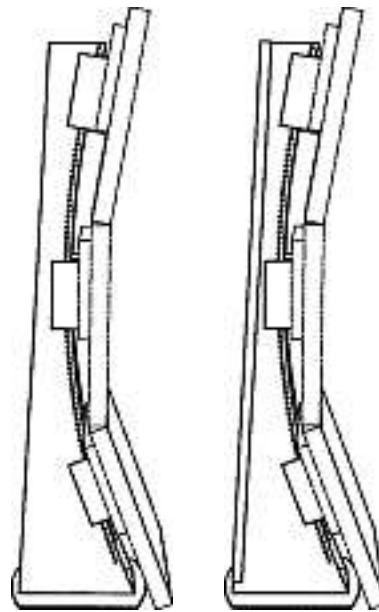
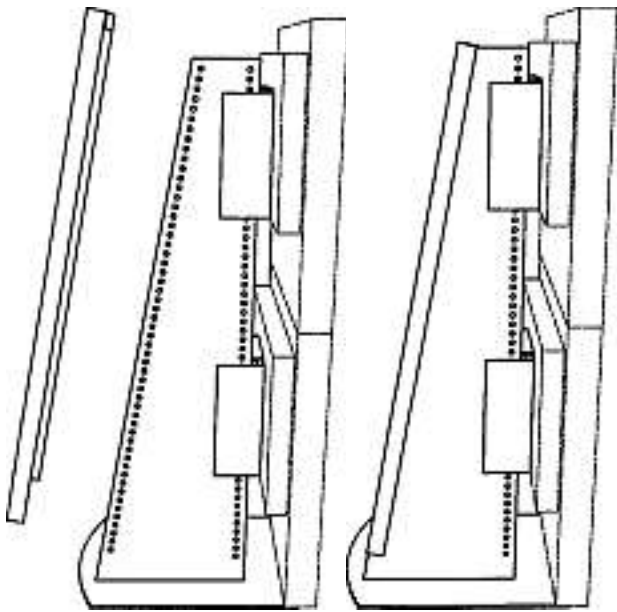

3

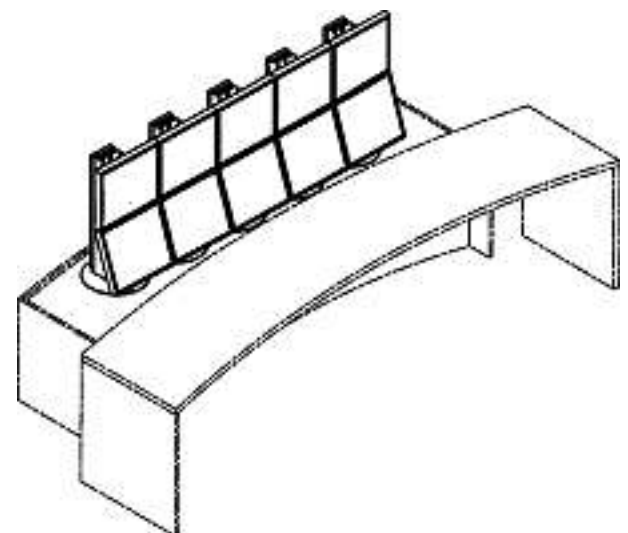

2

4

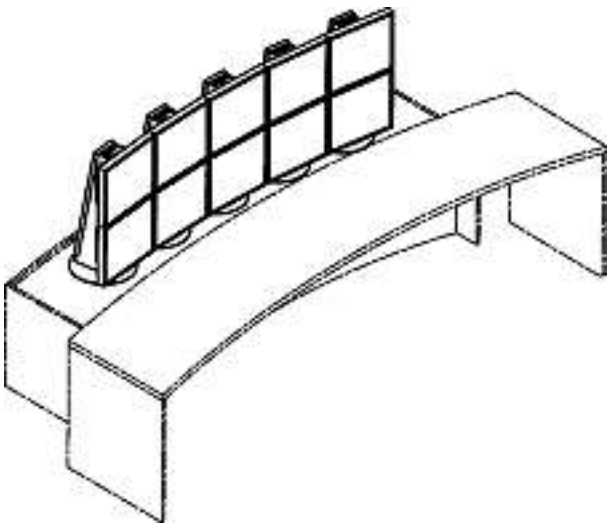

5

Cl. 15-09 **131 666** 09.03.2005
 3 Design – Schlauchschweißgerät und Teile
 Hinterleger: Reed Electronics AG, Gewerbering,
 6105 Schachen LU
 Designer: Thomas Christen, Schwarzenberg



40000



41000





45000

Cl. 16-06 **131 667** 18.02.2005
3 Design – Ornamente für Brillen, Teile von Brillen,
Sonnenbrillen
Hinterleger: WIS, 30, rue de Campo Formio, Paris, FR
Designer: Alain Miklitarian, Paris
Vertreter: Kikinis Rohner Schwenninger Weinmann,
8032 Zürich
Priorität: EM, 07.09.2004

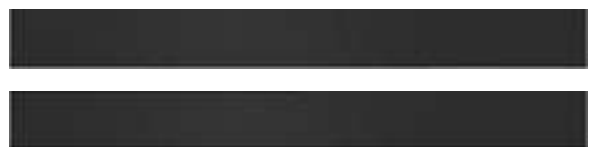
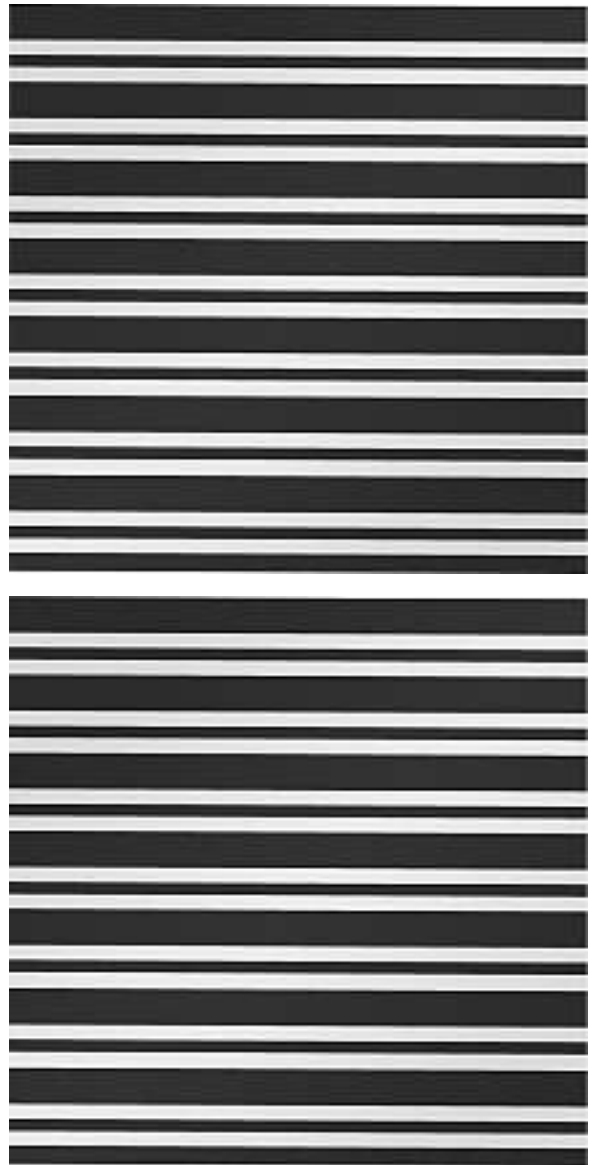

WISDCH01

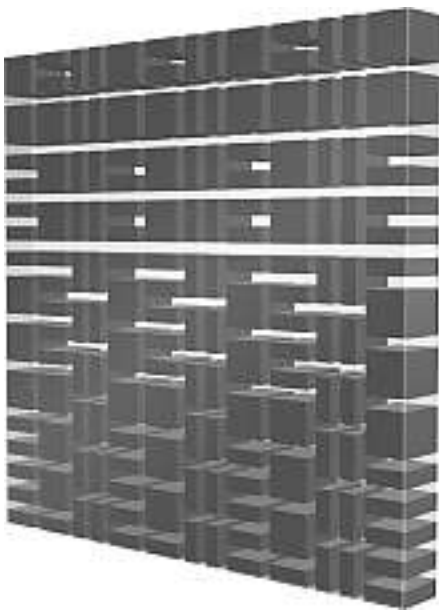

WISDCH02

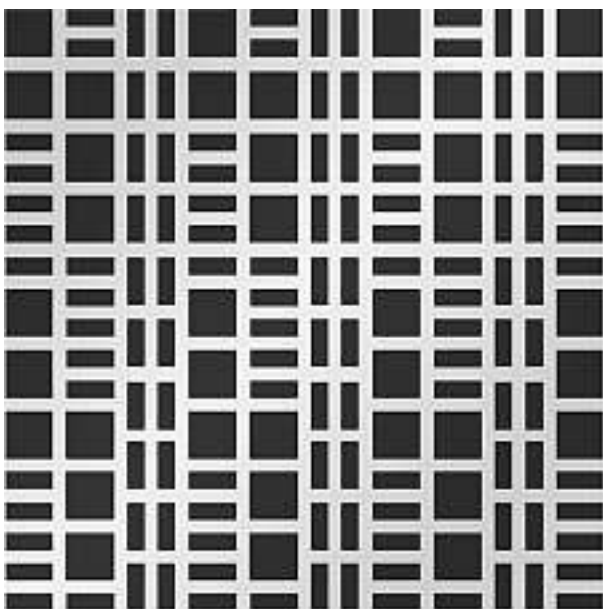
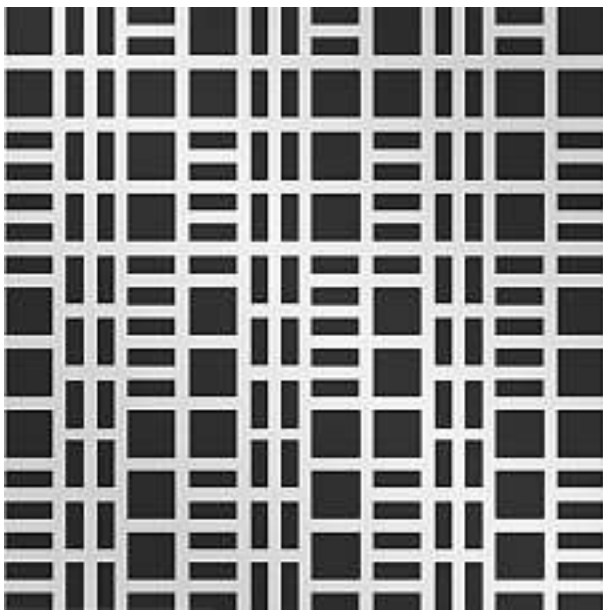

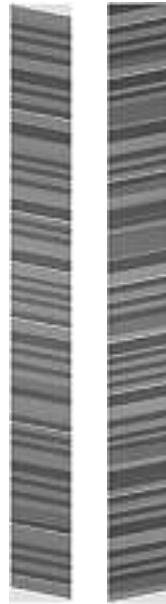

WISDCH03

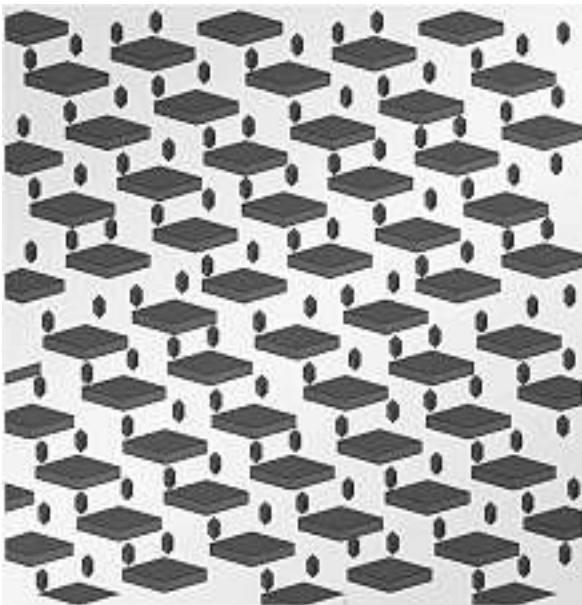

Cl. 18-01 **131 668** 15.03.2005

2 Design – Rechner
Hinterleger: PI-DESIGN AG, Kantonsstrasse 100,
6234 Triengen
Designer: Jorgen Bodum, St. Niklausen
Vertreter: Isler & Pedrazzini AG, 8023 Zürich
Priorität: DK, 16.09.2004



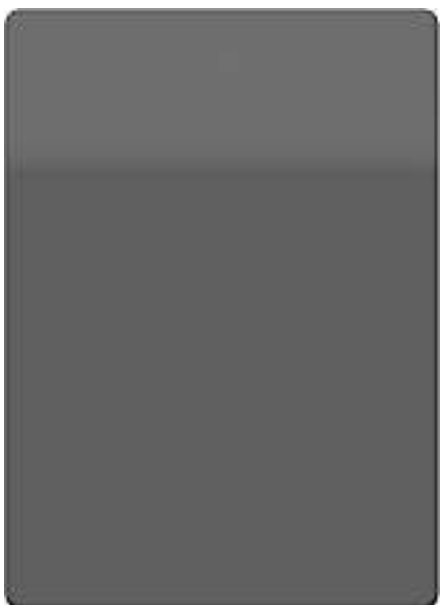
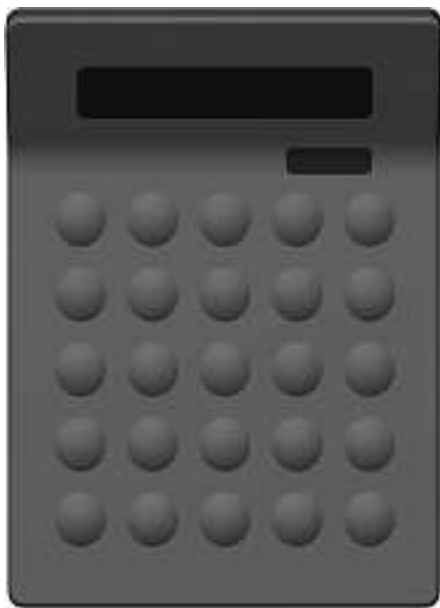
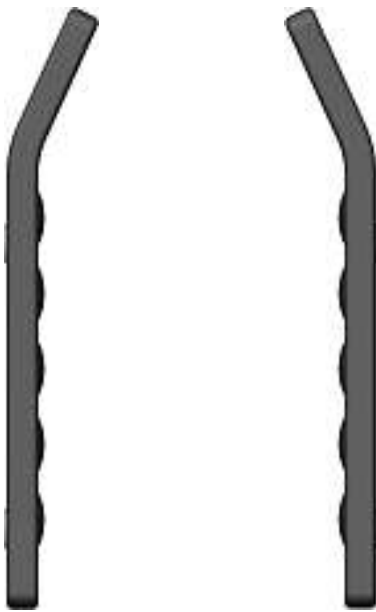

M13012/1

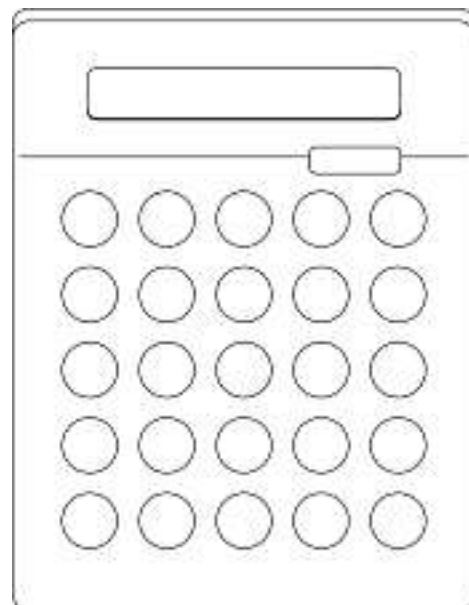
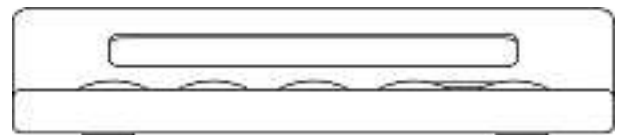

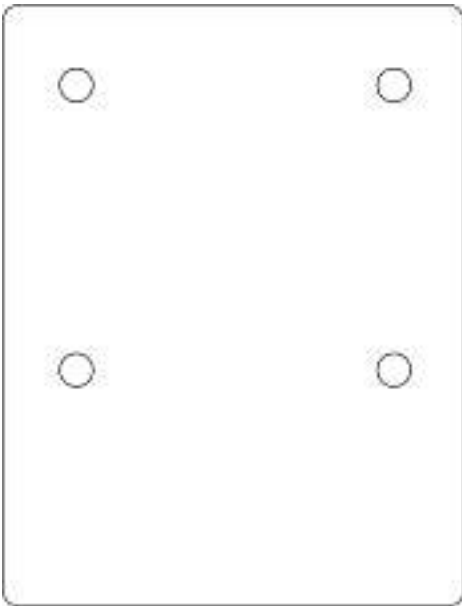

M13012/2

Cl. 19-06 131 669 21.03.2005
 2 Design – Kugelschreiber
 Hinterleger: Klio-Eterna Schreibgeräte GmbH & Co. KG,
 Glashüttenweg 7, Wolfach, DE
 Designer: Hariolf Briggel, Böbingen; Konrad Volk, Steinach
 Vertreter: Hans Rudolf Gachnang, Patentanwalt,
 8501 Frauenfeld
 Priorität: EM, 13.12.2004; EM, 13.12.2004

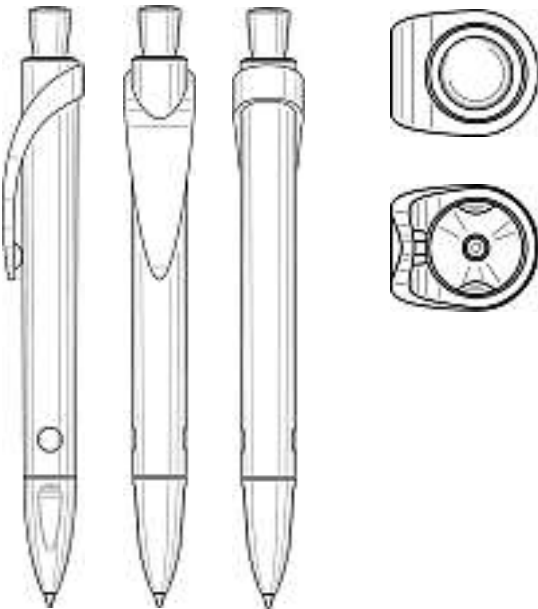

1

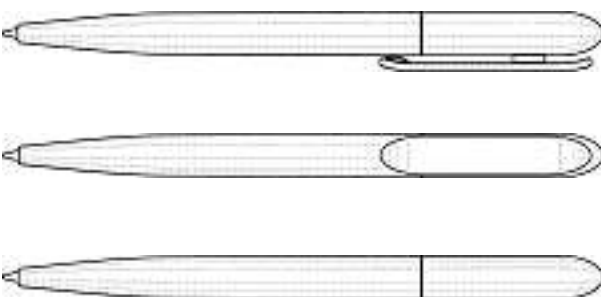

2

Cl. 19-07 131 671 11.03.2005
 1 design – disque de tonalités musicales
 Déposant: Nadia Stephanov, 42, rue Rothschild, 1202 Genève
 Mandataire: Leman Consulting S.A., 1260 Nyon



1

Cl. 19-08 131 672 08.03.2005
 2 Design – Druckvorlage
 Hinterleger: Edgar Muriset, Hauptstrasse 44, 4456 Tenniken



C1

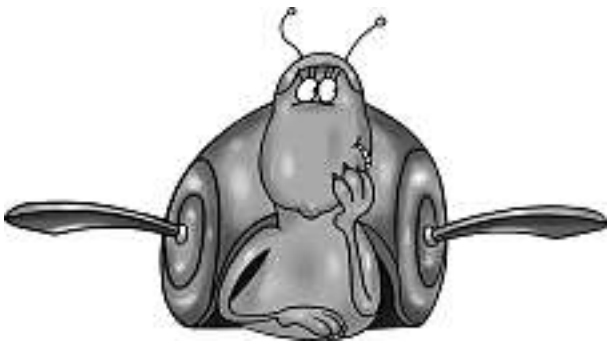

C2

Cl. 21-03 **131 675** 14.03.2005
 1 Design – Grafische Benutzeroberfläche
 Hinterleger: CFPH, LLC, 135 E. 57th Street, New York NY, US
 Designer: Lee M. Amaitis, London; James C. Johnson, Creskill
 Vertreter: E. Blum & Co., 8044 Zürich
 Priorität: US, 14.09.2004

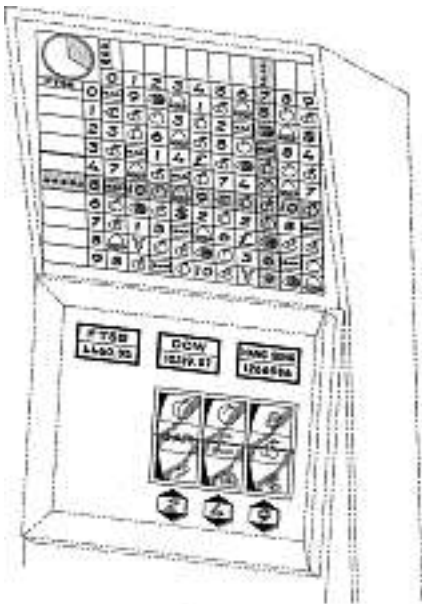

M2004/1011

Cl. 23-04 **131 676** 23.03.2005
 1 Design – Gehäuse für Ionisierungsgeräte
 Hinterleger: Frédéric Dedelley, Badenerstrasse 123a, 8004 Zürich



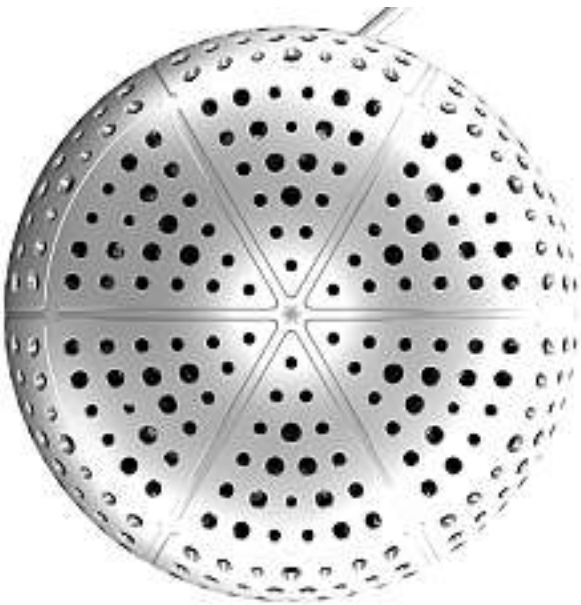

1. Cloud Nr. 3

Cl. 25-03 **131 677** 15.03.2005
 1 Design – Raucherkabine
 Hinterleger: Philip Bill Bruckner, Holbeinstrasse 89,
 4051 Basel

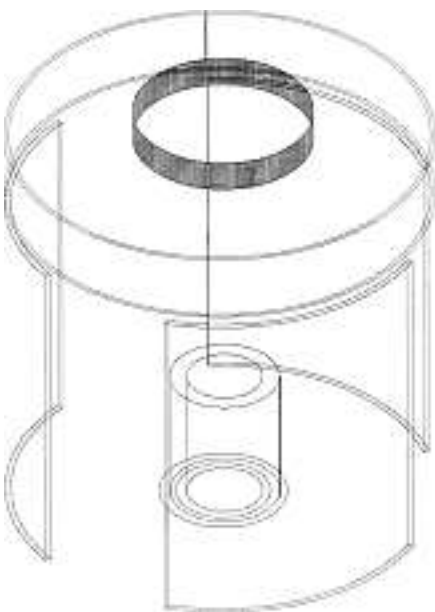

1.1.2004

Cl. 26-05 **131 678** 14.03.2005
 1 Design – Lampe
 Hinterleger: Rolf Benz AG & Co. KG, Haiterbacher Strasse
 104, 72202 Nagold, DE
 Designer: Antje Ulrich, Nagold
 Vertreter: Bovard AG, 3000 Bern 25
 Priorität: EM, 05.10.2004



300456-1

Cl. 26-06 **131 679** 10.03.2005
 2 design – fanaleria anteriore e posteriore per motoscooter
 Depositante: Honda Motor Co., Ltd., No. 1-1, 2-chome,
 Minami-aoyama, Minato-ku, Tokyo, JP
 Designer: Teofilo Plaza, Roma; Lorenzo Palazzo, Roma
 Mandatario: Fiammenghi-Fiammenghi, 6900 Lugano
 Priorità: JP, 30.09.2004





1





2

Verlängerungen
Prolongations
Prolongazioni

118 176 Cl. 10-07 1 Design

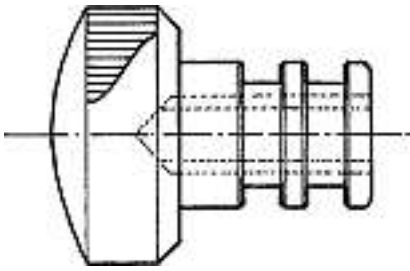

1

118 215 Cl. 19-02 2 design



1



2

118 352 Cl. 25-01 1 Design

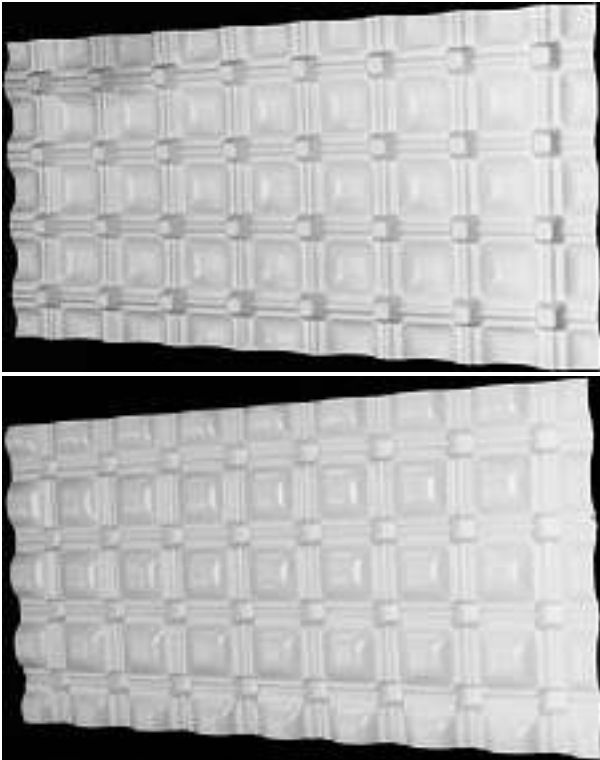

1

122 284	Cl.	09-03	1 design
122 400	Cl.	07-06	1 Design
122 541	Cl.	21-01	2 Design
126 806	Cl.	17-02	9 Design
126 933	Cl.	07-01	1 Design
126 934	Cl.	07-01	1 Design
126 938	Cl.	08-03	1 design
126 939	Cl.	09-03	2 Design
126 961	Cl.	26-05	1 Design
126 976	Cl.	06-04	2 Design
126 978	Cl.	06-04	1 Design
126 981	Cl.	06-09	1 Design
127 008	Cl.	21-02	1 Design
127 014	Cl.	04-02	1 Design
127 015	Cl.	04-02	1 Design
127 051	Cl.	06-11	1 Design
127 143	Cl.	08-06	1 design
127 149	Cl.	10-02	1 design
127 179	Cl.	06-01	4 Design
127 229	Cl.	19-08	1 Design
127 251	Cl.	07-02	4 Design
127 254	Cl.	09-03	2 Design

Mutationen Modifications Modificazioni

122 284

Nouveau mandataire
Mandataire: Micheli & Cie, 1226 Thônex (Genève)

122 315

Neuer Vertreter
Vertreter: Schmauder & Partner AG, Patentanwälte VSP,
8038 Zürich

122 511

Neuer Vertreter
Vertreter: R. A. Egli & Co., Patentanwälte, 8008 Zürich

124 481**124 726**

Neuer Vertreter
Vertreter: AXON Patent GmbH, 4147 Aesch

125 858**125 859**

Nouveau mandataire
Mandataire: A. Braun, Braun, Héritier, Eschmann AG,
Patentanwälte, 4051 Basel

131 478

Transmission
Déposant: Frédérique Constant SA, 39, rue Peillonex,
1225 Chêne-Bourg

Löschungen Radiations Radiazioni

117 760	Cl.	19-04	8 Design
117 761	Cl.	24-03	4 Design
117 800	Cl.	28-03	4 Design
117 864	Cl.	10-04	1 Design
121 704	Cl.	02-03	3 Design
121 723	Cl.	09-03	1 Design
121 742	Cl.	25-01	1 Design
121 755	Cl.	03-01	2 Design
121 764	Cl.	06-06	2 Design
121 788	Cl.	24-02	2 design
121 810	Cl.	12-05	1 Design
121 826	Cl.	24-02	1 Design
121 897	Cl.	19-08	2 Design
126 401	Cl.	05-04	2 Design
126 403	Cl.	05-05	16 design
126 413	Cl.	09-05	3 Design
126 439	Cl.	02-05	29 Design
126 441	Cl.	05-05	6 Design
126 444	Cl.	06-01	4 Design
126 445	Cl.	06-01	16 Design
126 446	Cl.	06-03	1 Design
126 447	Cl.	06-03	1 Design
126 449	Cl.	06-04	4 Design
126 454	Cl.	08-05	1 Design
126 455	Cl.	09-01	1 Design
126 456	Cl.	09-05	3 Design
126 459	Cl.	10-02	1 Design
126 461	Cl.	11-01	2 design
126 465	Cl.	14-03	1 Design
126 468	Cl.	20-02	1 Design
126 470	Cl.	21-01	1 design
126 474	Cl.	26-01	32 Design
126 475	Cl.	26-02	2 Design
126 476	Cl.	26-05	1 Design
126 477	Cl.	26-05	1 Design
126 479	Cl.	30-04	4 Design
126 507	Cl.	15-05	1 Design
126 508	Cl.	19-02	1 Design
126 509	Cl.	19-08	1 design