

Nationale Hinterlegungen

In der folgenden Liste werden die beim Eidgenössischen Institut für Geistiges Eigentum hinterlegten Designs publiziert. Dabei sind der Reihe nach angegeben:

- internationale Klassenangaben
- Hinterlegungsnummer
- Hinterlegungsdatum
- Allenfalls Aufschub der Veröffentlichung
- Anzahl der hinterlegten Designs
- Bezeichnung
- Name und Wohnsitz des Hinterlegers oder der Hinterlegerin
- gegebenenfalls Name und Wohnsitz des Designers oder der Designerin
- Name und Geschäftssitz des allfälligen Vertreters oder der Vertreterin
- gegebenenfalls Prioritätsangaben
- gegebenenfalls Beschreibungstext
- Ordnungsnummer
- Reproduktion des Designs

Internationale Hinterlegungen

Die bei der Weltorganisation für geistiges Eigentum in Genf hinterlegten Muster und Modelle mit Benennung Schweiz geniessen den gleichen Schutz wie national hinterlegte Designs. Sie werden jeweils im Blatt «Bulletin des dessins et modèles internationaux» veröffentlicht. Dieses Publikationsorgan ist deshalb für eine vollständige Recherche unbedingt beizuziehen.

Topographien

Angaben über die vom Eidgenössischen Institut für Geistiges Eigentum eingetragenen Topographien von Halbleitererzeugnissen werden in folgender Anordnung aufgeführt:

- Eintragsnummer
- Anmeldedatum
- Bezeichnung
- Name und Wohnsitz des Anmelders oder der Anmelderin
- gegebenenfalls Name und Wohnsitz des Herstellers oder der Herstellerin
- Name und Geschäftssitz des oder der allfälligen Bevollmächtigten
- Datum und Ort einer allfälligen ersten geschäftlichen Verbreitung der Topographie

Dépôts nationaux

Les designs déposés à l'Institut Fédéral de la Propriété Intellectuelle sont publiés dans la liste qui suit. Les indications y relatives sont mentionnées dans cet ordre:

- indications des classes internationales
- numéro de dépôt
- date de dépôt
- le cas échéant, ajournement de la publication
- nombre des designs déposés
- désignation
- nom et domicile du/de la déposant/e
- le cas échéant, nom et domicile du/de la designer
- nom et domicile de l'éventuel/le mandataire
- le cas échéant, indication de priorité
- le cas échéant, description du design
- numéro attribué à chaque design
- reproduction du design

Dépôts internationaux

Les dessins et modèles déposés à l'Organisation Mondiale de la Propriété Intellectuelle à Genève qui désignent la Suisse jouissent de la même protection que les dépôts nationaux. Ils sont chaque fois publiés dans la feuille «Bulletin des dessins et modèles internationaux». Pour une recherche complète, il est indispensable de consulter ledit organe de publication.

Topographies

Les indications concernant les topographies des produits semi-conducteurs, enregistrées par l'Institut Fédéral de la Propriété Intellectuelle, sont énumérées dans l'ordre suivant:

- numéro d'enregistrement
- date de dépôt
- désignation
- nom et domicile du/de la déposant/e
- le cas échéant, nom et domicile du/de la producteur/trice
- nom et domicile de l'éventuel/le mandataire
- date et lieu d'une éventuelle première mise en circulation de la topographie

Depositi nazionali

Nella lista seguente vengono pubblicati i design depositati presso l'Istituto Federale della Proprietà Intellettuale. Sono menzionati nel seguente ordine:

- indicazioni delle classi internazionali
- numero di deposito
- data del deposito
- se del caso, indicazione che la pubblicazione è stata differita
- numero dei design depositati
- designazione
- nome e domicilio del depositante
- se del caso, nome e domicilio del designer
- nome e sede di un eventuale mandatario
- se del caso, indicazioni di priorità
- se del caso, descrizione del design
- numero d'ordine
- riproduzione del design

Depositi internazionali

I disegni e modelli depositati presso l'Organizzazione Mondiale della Proprietà Intellettuale a Ginevra con denominazione Svizzera godono della medesima protezione del deposito nazionale. Essi vengono pubblicati ogni volta nel foglio «Bulletin des dessins et modèles internationaux». Quest'organo di pubblicazione è da consultare se si vuole effettuare una ricerca completa.

Topografie

Le indicazioni concernenti le topografie di prodotti a semiconduttori depositati presso l'Istituto Federale della Proprietà Intellettuale sono menzionate nell'ordine seguente:

- numero di registrazione
- data del deposito
- designazione
- nome e domicilio del/la richiedente
- se del caso, nome e domicilio del/la produttore/trice
- nome e sede di un eventuale mandatario
- data e luogo di un'eventuale prima messa in circolazione della topografia

Hinterlegungen Dépôts Deposit

Cl. 2-01 **130 462** 16.02.2004
1 design – chemise de nuit
Georgina Stauffer, Neubrücke 25, 2555 Brügg BE



Cl. 2-06 **130 464** 17.03.2004
1 Design – Arbeitshandschuhe
Showa Co., 565 Thorori, Himeji-shi, Hyogo (JP). Rechtsnachfolgerin des Designers Masato Yamamoto, Hyogo.
Vertr.: Ammann Patentanwälte AG Bern, Bern
Prior.: Japan 22.09.2003

57966 CH (siehe Farbteil Heftmitte)

Cl. 3-01 **130 465** 27.02.2004
2 Designs – Werkzeugkoffer
Hilti Aktiengesellschaft, Feldkircherstrasse 100, Schaan (LI). Rechtsnachfolgerin der Designer Stephan Niehaus, Rheineck und Roland Loew, Klein-Winternheim.
Vertr.: Hilti Befestigungstechnik AG, Buchs SG
Prior.: EM 10.11.2003

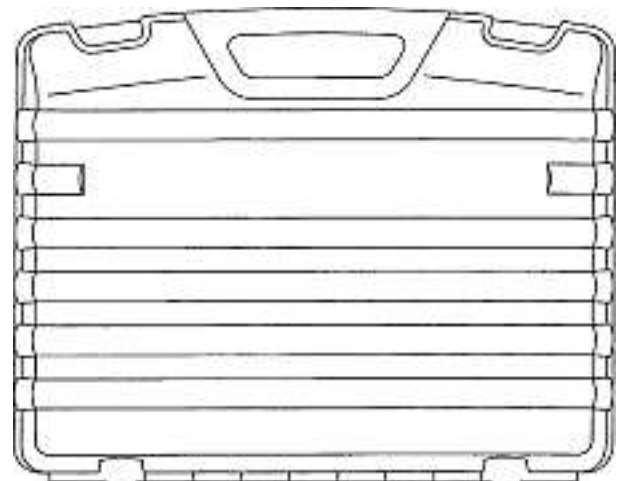
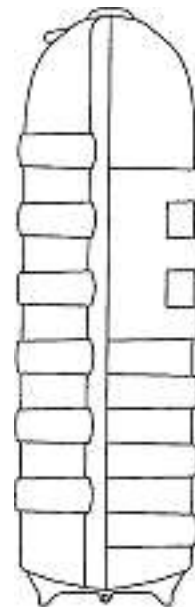
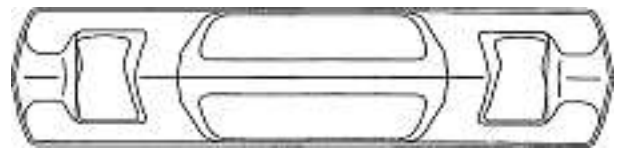



Koffer I

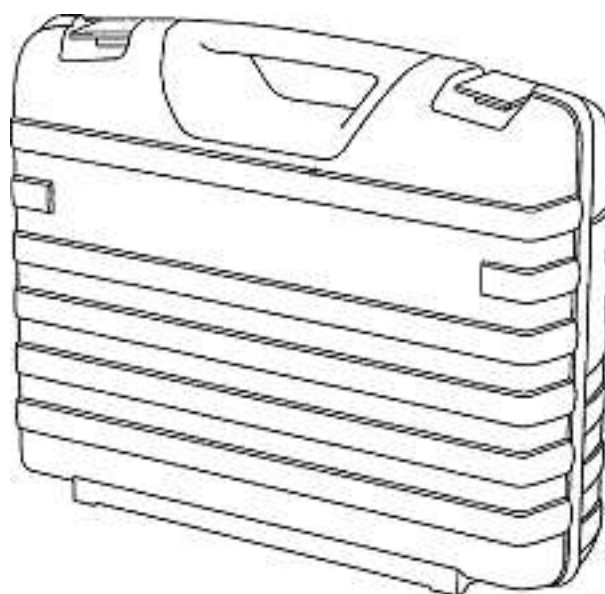
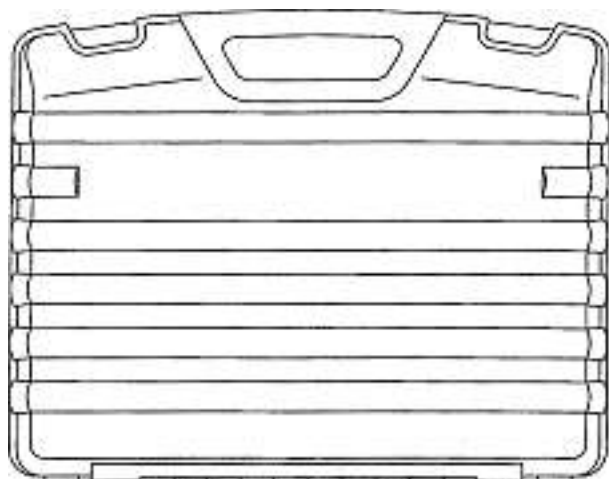
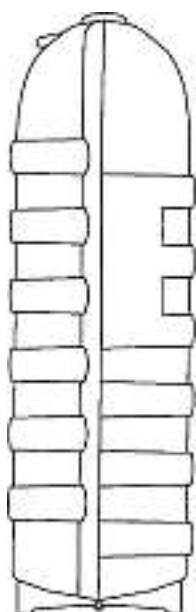
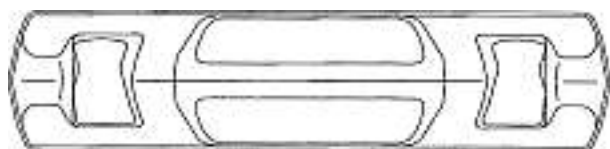

Koffer II

Cl. 3-01 **130 466** 10.03.2004

2 designs – écrin pour l'horlogerie
 Underwood S.A., Route de la Clochette 5,
 1052 Le Mont-sur-Lausanne. Ayant cause du designer
 Alessandro Rustioni, Vallina – Bagno a Ripoli.
 Mand.: Griffes Consulting S.A., Genève





MO-56525-CH





MO-56526-CH

Cl. 6-01, 03 **130 467** 13.02.2004
 2 Designs – Tisch, Sitzbank
 Art & Food Niklas & Simon Buchs, Chalet Madora, 3780 Gstaad.
 Rechtsnachfolgerin des Designers Simon Buchs, Gstaad





MOVE ME 1



MOVE ME 2

Cl. 6-06 **130 470** 09.02.2004
 2 Designs – Möbelverbindungen
 Matthias Eugster, Feldstrasse 25, 4900 Langenthal

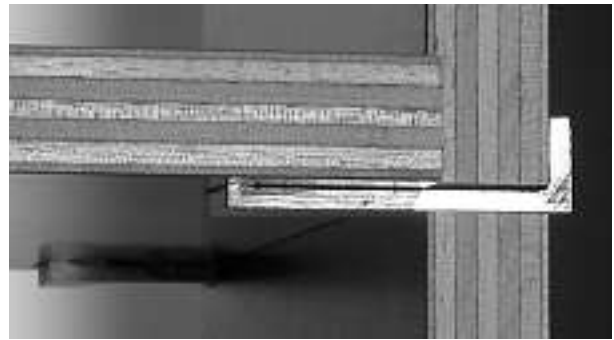

Synos 1

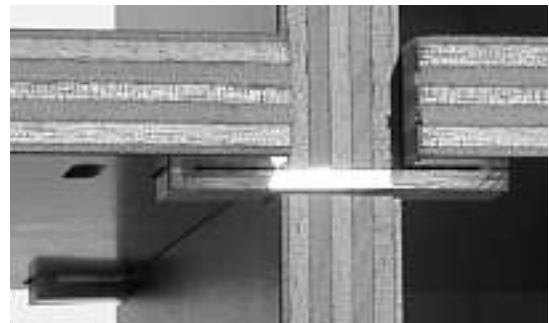

Synos 2

Cl. 6-09 **130 471** 10.02.2004
 1 Design – Kissen
 Irmgard Ida Durot, Burg, 9424 Rheineck



water-dream

Cl. 6-04 **130 469** 18.02.2004
 1 Design – Regal
 Bruno Messerli, Hauptstrasse 106, Brittern, 4587 Aetingen



Winregal

Cl. 7-01 130 472 11.02.2004
 1 design – assiette
 Gérald Cantova, En Tzatio, 1410 Thierrens



1

Cl. 7-01 130 473 11.02.2004
 1 Design – Trinkgefäßhenkel
 Brigitte Reutimann, Rietweg, 8476 Unterstammheim
 und Markus Reutimann, Rietweg, 8476 Unterstammheim.
 Vertr.: Brigitte Reutimann, Unterstammheim

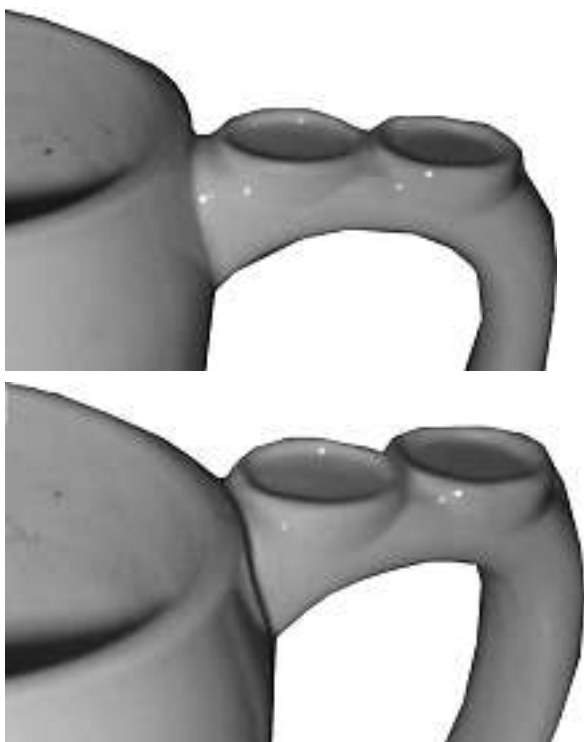

Schnupfhumpen

Cl. 7-02 130 474 17.02.2004
 1 Design – Windschutz
 A. & J. Stöckli AG, Ennetbachstrasse 40, 8754 Netstal.
 Rechtsnachfolgerin des Designers Herbert Forrer, Glarus



1

Cl. 7-02 130 475 16.03.2004
 1 Design – Spritzschutz für Caquelon
 Kuhn Rikon AG, 8486 Rikon im Tösstal. Rechtsnachfolgerin
 der Designer Lukas Weiss, Zürich und Marco Braun, Cham.
 Vertr.: Isler & Pedrazzini AG, Zürich

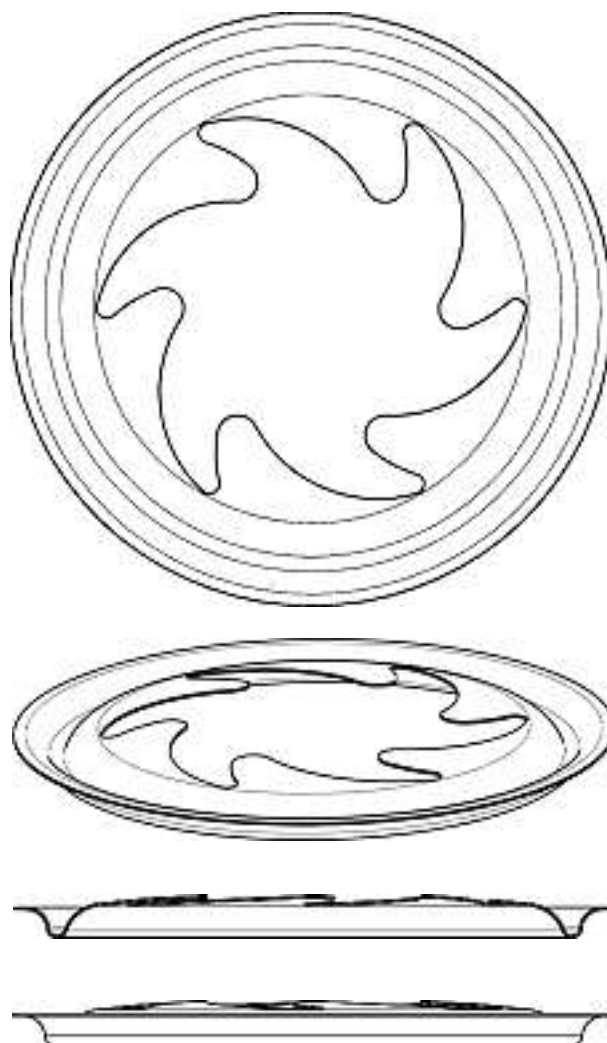

M12888

Cl. 7-04 130 476 18.02.2004
 1 Design – Lebensmittelhacker
 Betty Bossi Verlag AG, Bürglistrasse 29, 8002 Zürich.
 Rechtsnachfolgerin des Designers Ruedi Eidenbenz,
 Triesen.
 Vertr.: Meyer Lustenberger, Zürich

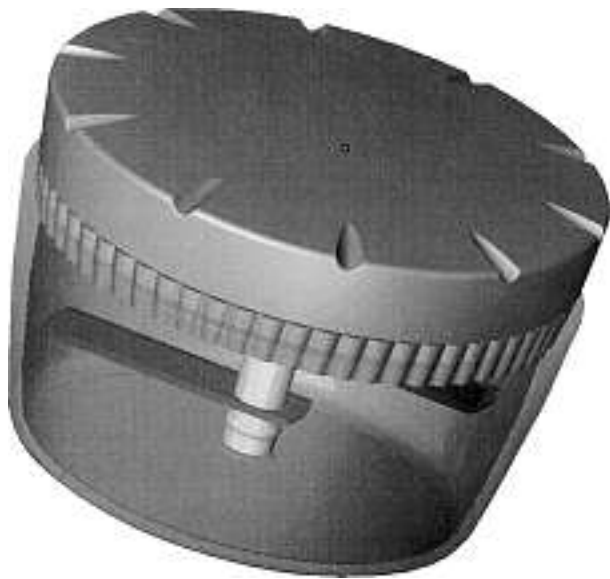

Speedy

Cl. 7-05 130 477 25.03.2004
 4 Designs – Schwämme
 a&n&a Nord-Süd-Industrie Vertriebs GmbH & Co. KG,
 Postfach 45, Merenberg (DE). Rechtsnachfolgerin des
 Designers Marc Krause, Weilburg.
 Vertr.: Isler & Pedrazzini AG, Zürich
 Prior.: EM 16.01.2004

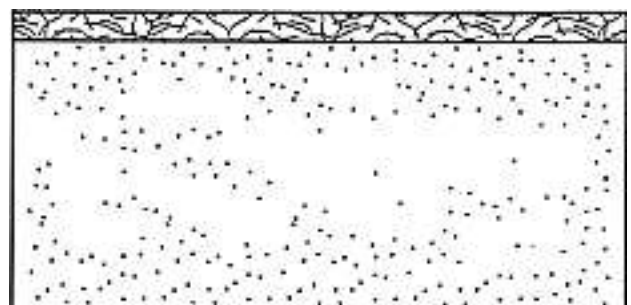
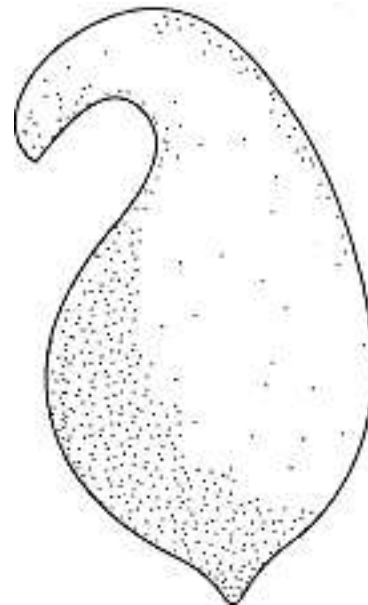
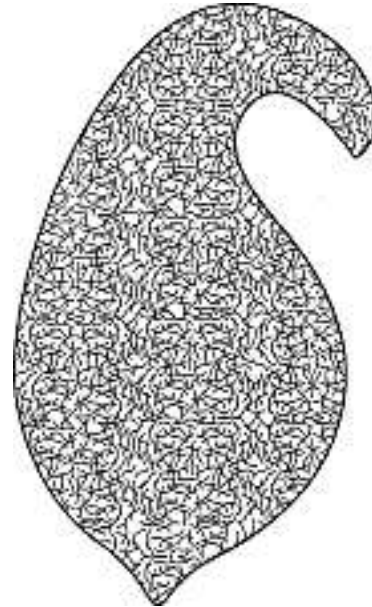

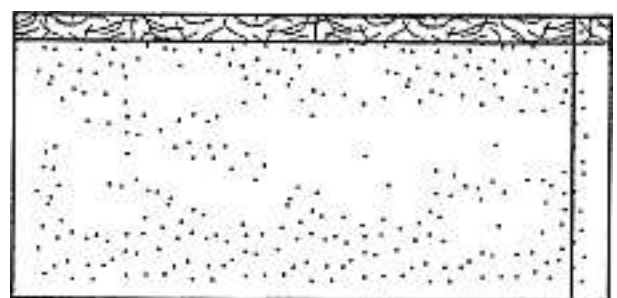
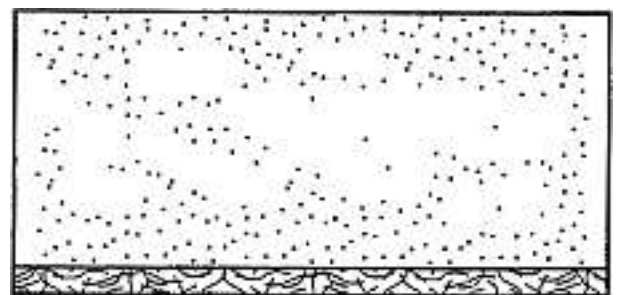
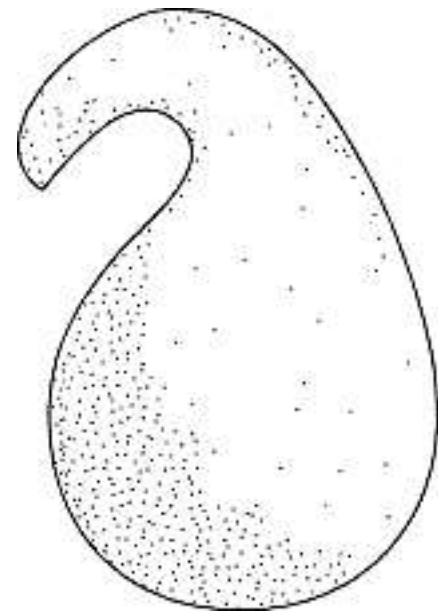
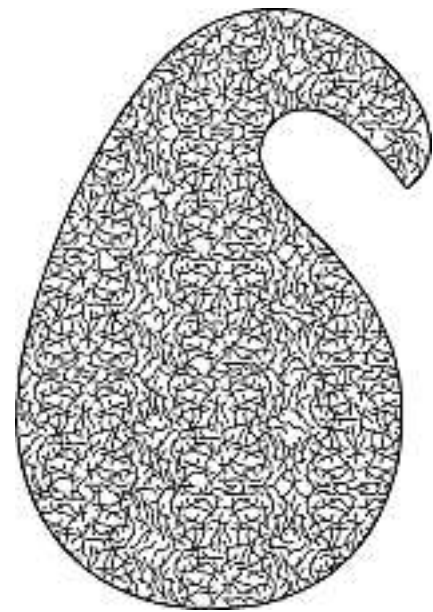
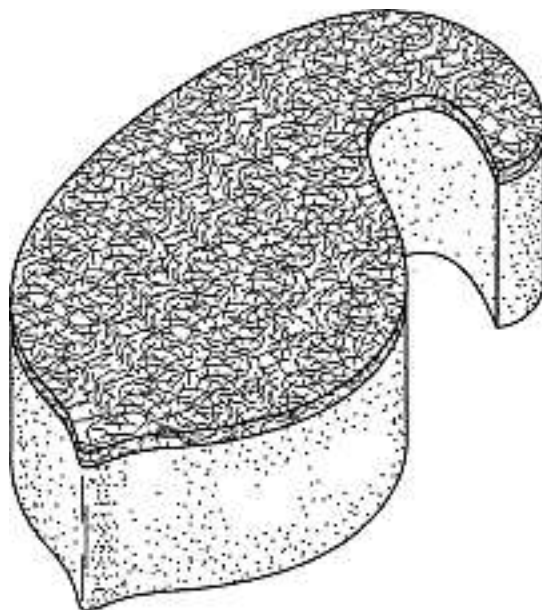
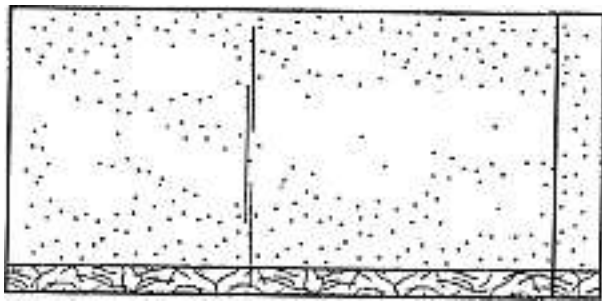

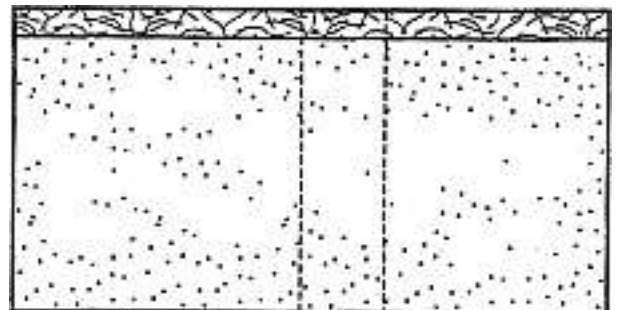
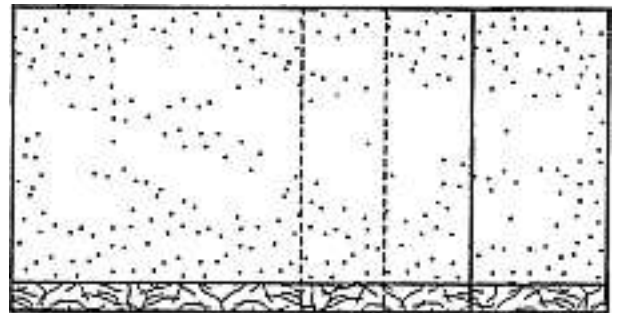
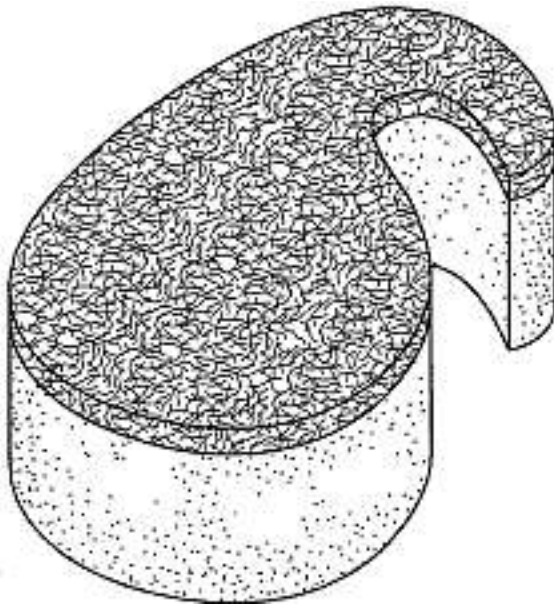
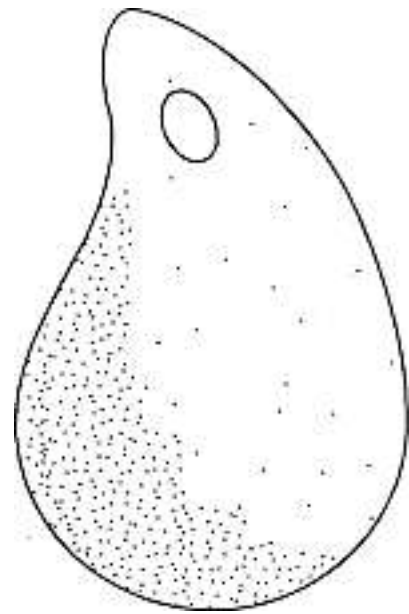
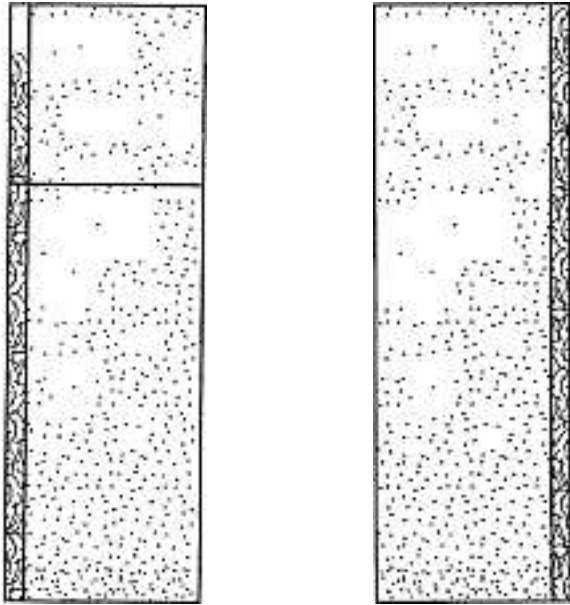

M12889 (2)

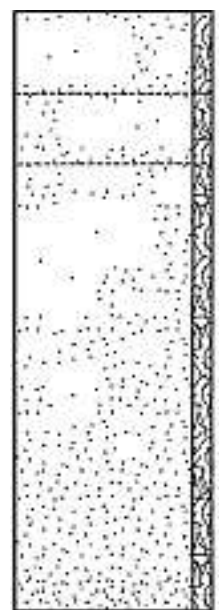
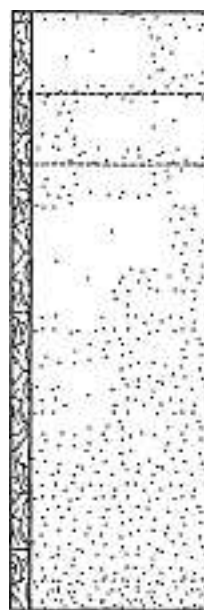
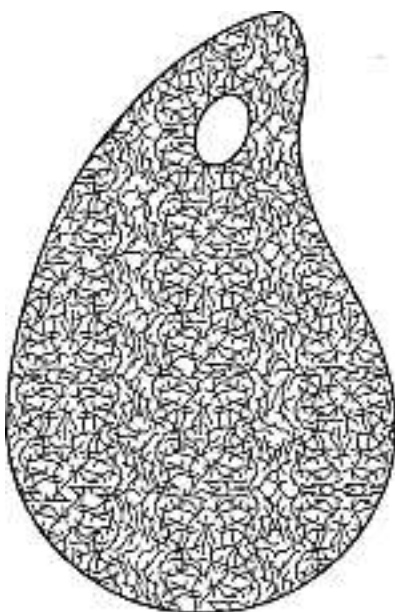

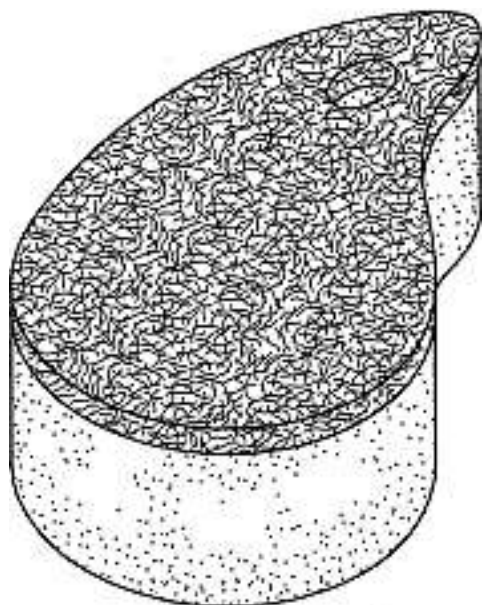

M12889 (3)

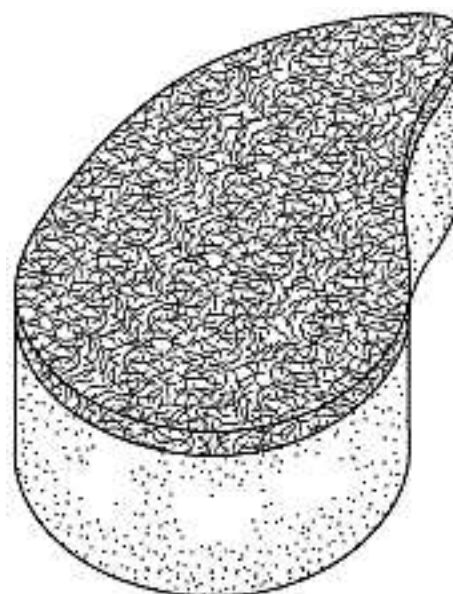
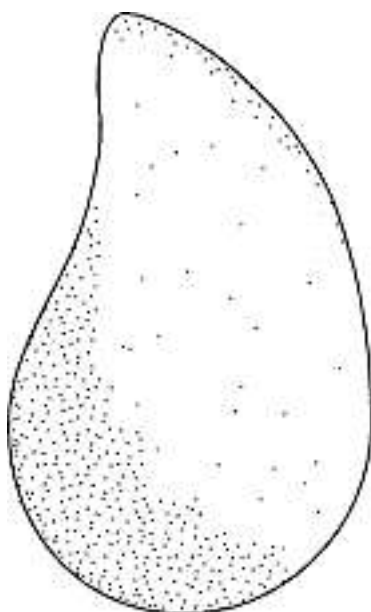
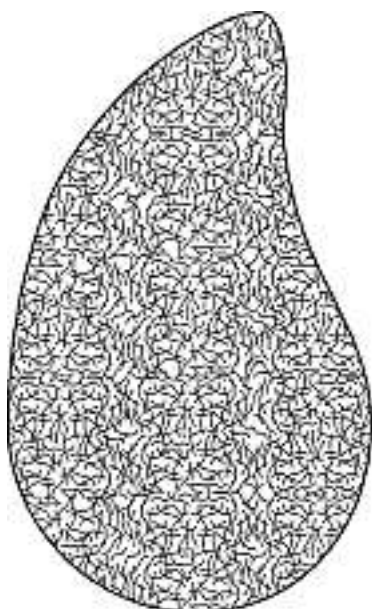
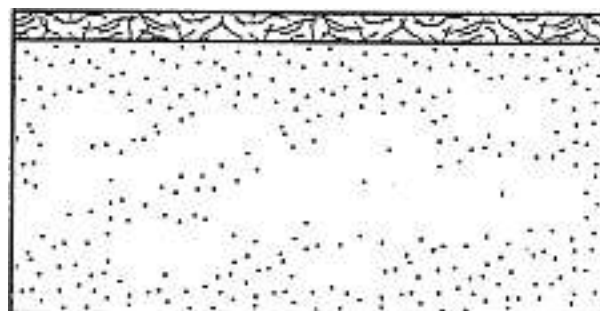
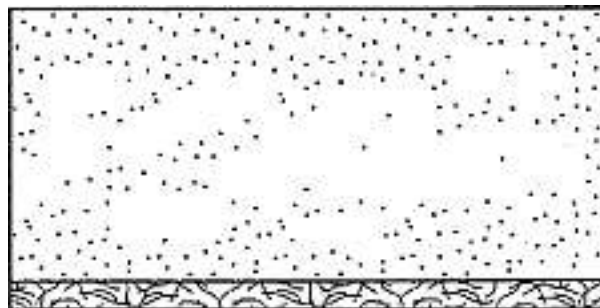

M12889 (4)

Cl. 8-01 130 478 13.02.2004
 2 Designs – Werkzeuge
 Airtec AG, Industriestrasse 40, 4455 Zunzgen. Rechtsnachfolgerin des Designers René M. Wyser, Tenniken.
 Vertr.: Industrieberatung Maier AG, Sissach



QTS_1



QTS_5

Cl. 8-01 130 479 27.02.2004
 1 Design – Bohrer
 Sphinx Werkzeuge AG, Industriestrasse 6, 4562 Biberist.
 Rechtsnachfolgerin der Designer Reto Rüttimann, Recherswil; Martin Arnold, Gerlafingen und Claudio Mannori, Lohn-Ammannsegg.
 Vertr.: Braun & Partner, Basel

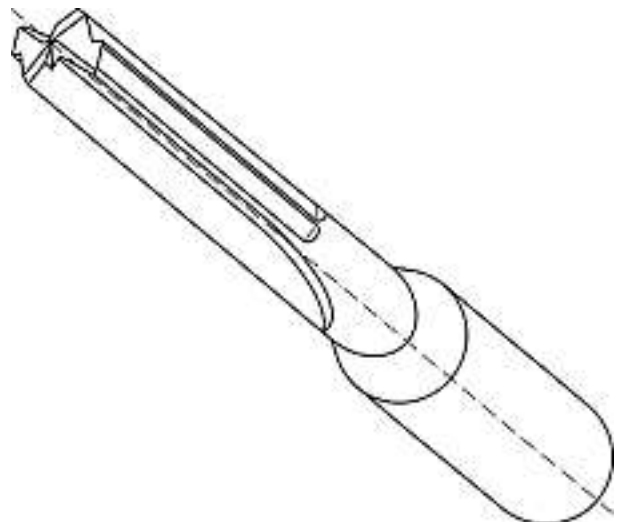

D60CH

Cl. 8-04 **130 480** 13.02.2004
 1 Design – Schraubenziehergriff
 Shu-Ling Chiu, No. 37, Lane 66, Sanmin 2nd St., Dali City,
 Taichung County (TW).
 Vertr.: Aldo Römpler, Heiden

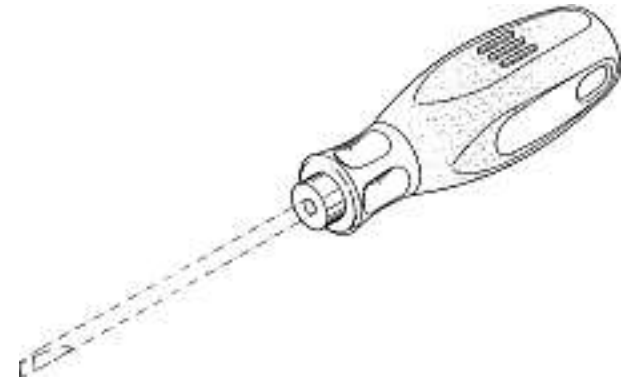
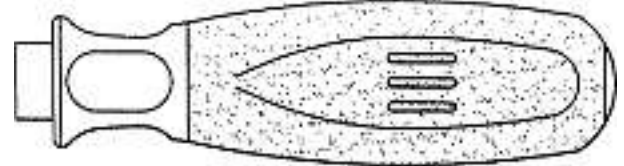
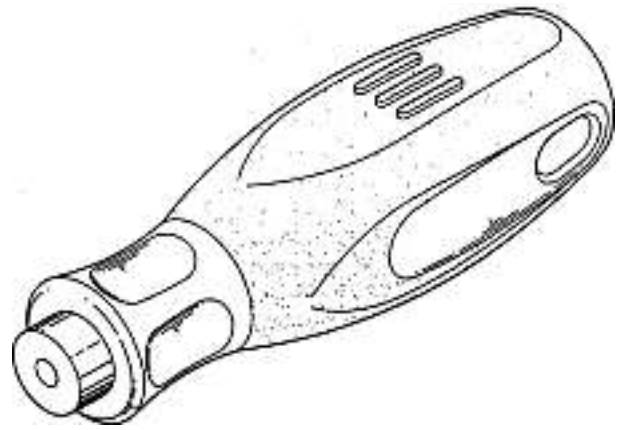
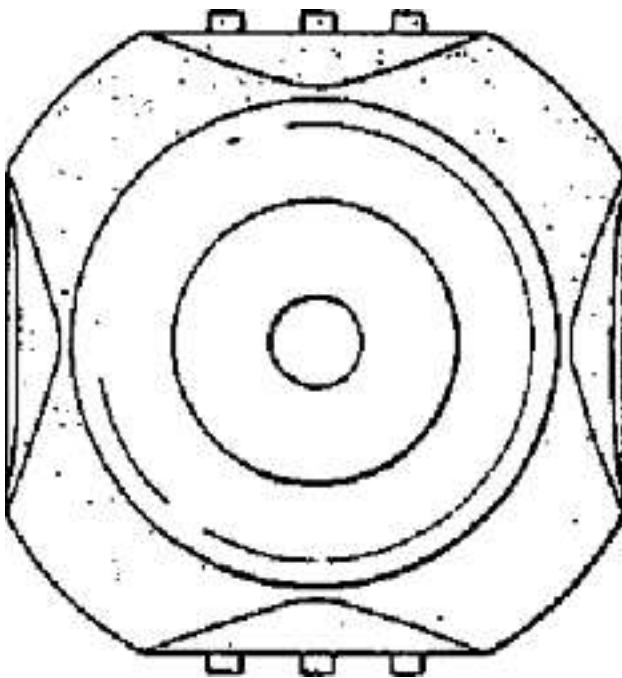
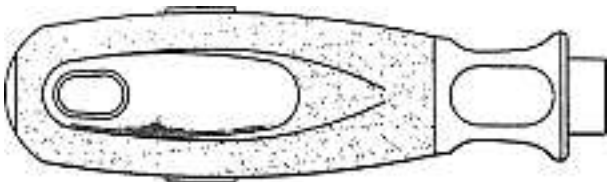
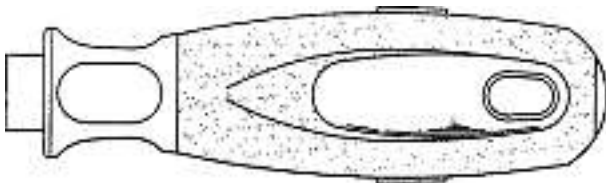
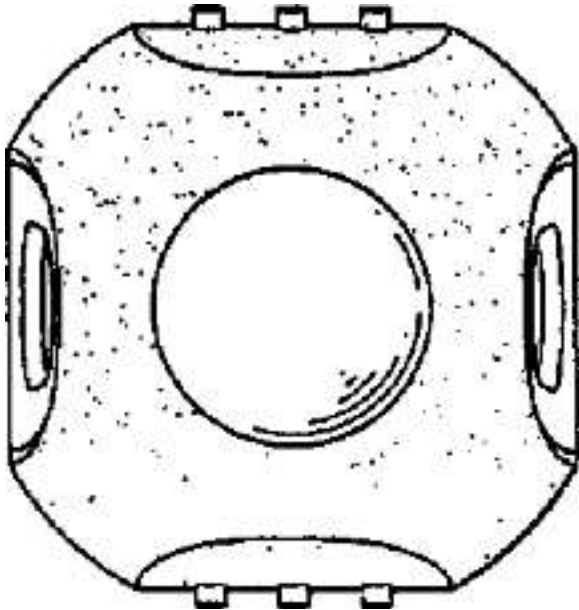

CFP-2302

Cl. 8-09 **130 481** 22.03.2004
 4 Designs – Türbeschläge
 EKU AG, Wilerstrasse 90, 8370 Sirmach. Rechtsnachfolgerin
 des Designers Michael Koch, Biberist.
 Vertr.: Hans Rudolf Gachnang, Frauenfeld

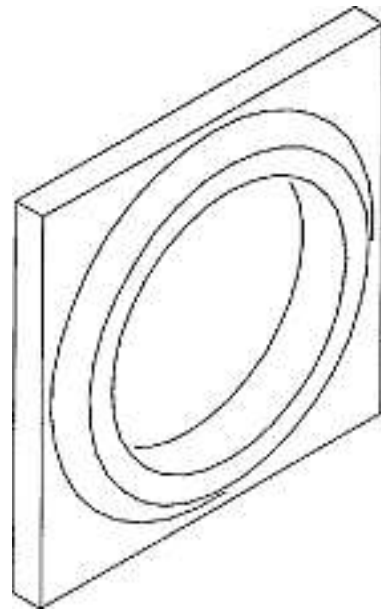

1

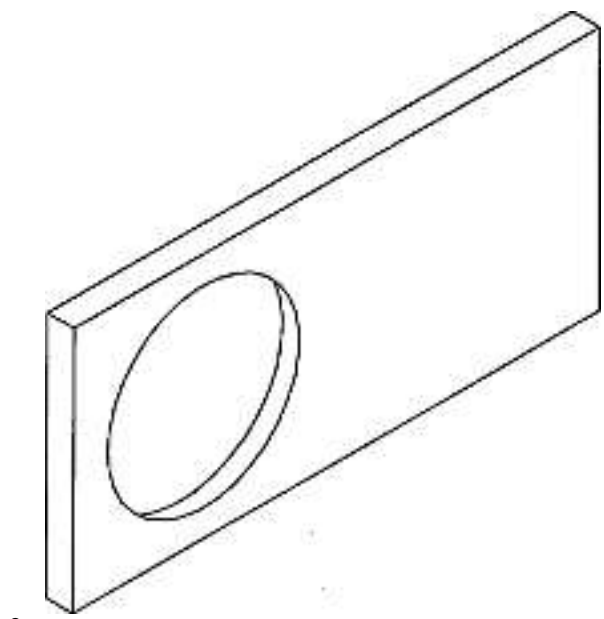

2



3

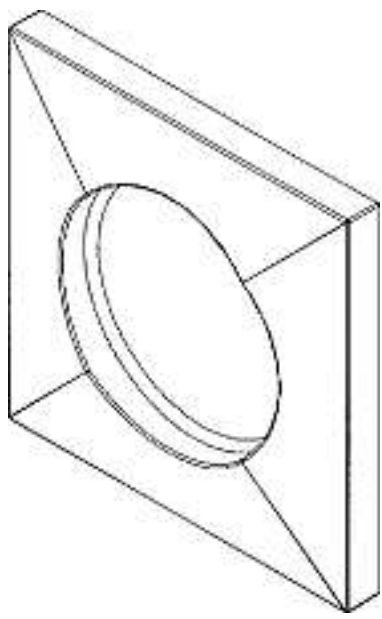

4

Cl. 9-01 **130 482** 28.01.2004

1 Design – Flasche
 Otsuka Pharmaceutical Co., Ltd, 2-9, Kanda Tsukasa-cho,
 Chiyoda-ku, Tokyo (JP). Rechtsnachfolgerin des Designers
 Tetsuo Fukuda, Narutoshi.
 Vertr.: R. A. Egli & Co., Zürich
 Prior.: Japan 04.08.2003

D 4265 (siehe Farbteil Heftmitte)

Cl. 9-01 **130 483** 12.03.2004

2 Designs – Flasche
 Heineken Technical Services B.V., Burgemeester Smeetsweg 1,
 PH Zoeterwoude (NL). Rechtsnachfolgerin des Designers
 Karl Hewson, Saffron Walden.
 Vertr.: E. Blum & Co., Zürich
 Prior.: Benelux 12.09.2003

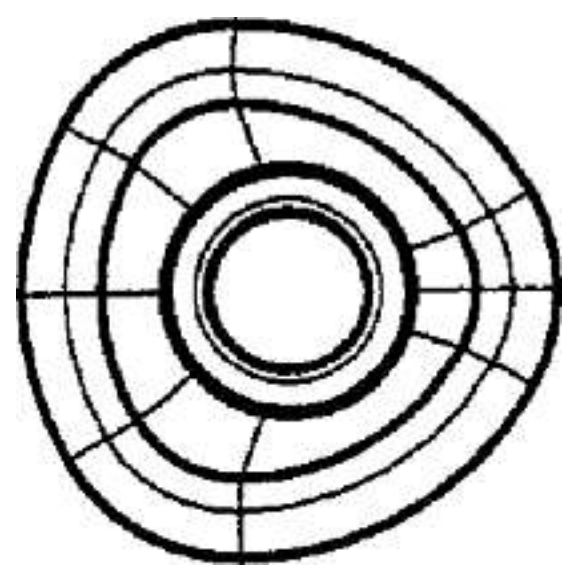
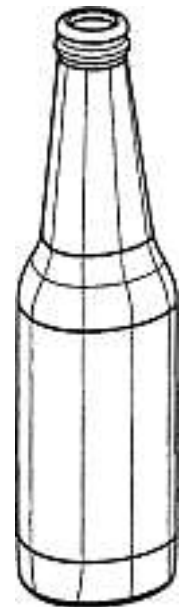

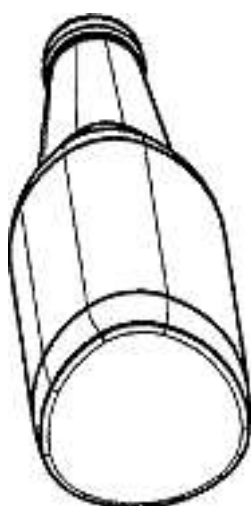
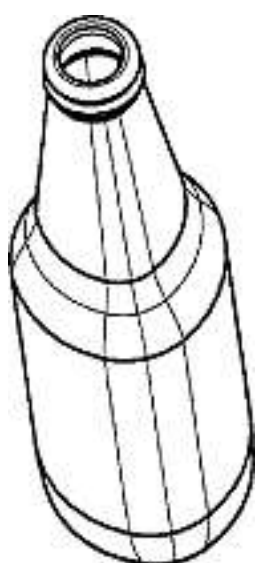
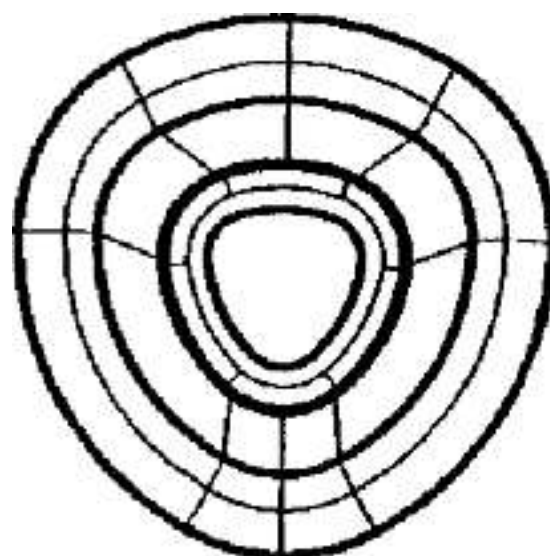
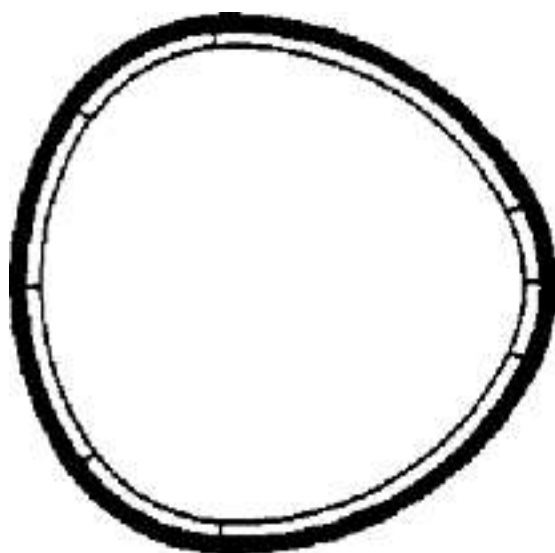
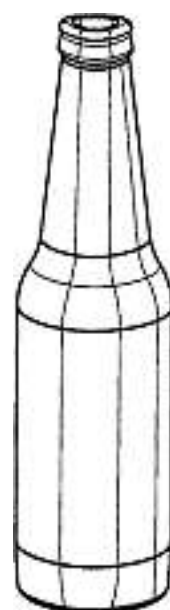

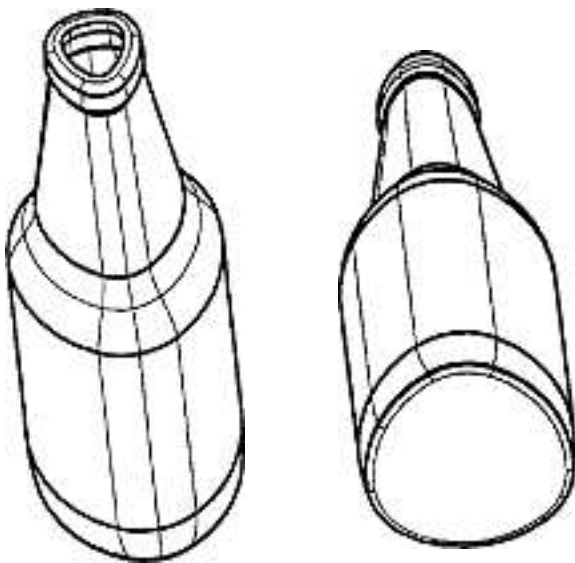
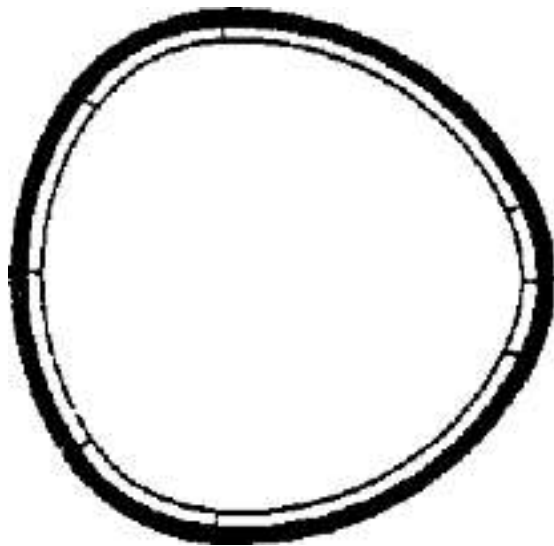

A-2004/1012-2



cube

Cl. 9-03 **130 485** 17.02.2004
 14 Designs – Getränkebehälter
 SIG Technology Ltd, Laufengasse 18, 8212 Neuhausen am
 Rheinfl. Rechtsnachfolgerin des Designers Luc Viardot,
 Aachen.
 Vertr.: Troesch Scheidegger Werner AG, Zumikon.
 Prior.: EM 18.08.2003

Cl. 9-03 **130 484** 11.02.2004
 1 design – emballage
 D & C Manufacture Sàrl, rte de la Gare 35, 2012 Auvernier.
 Ayant cause du designer Bernard Favre, Neuchâtel



1



2



3



4



5



6



7



8

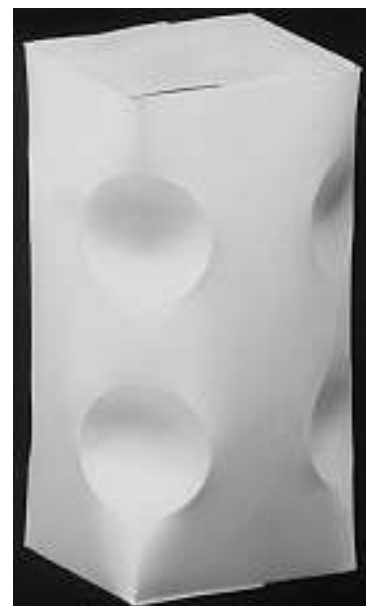

9



10





11



12

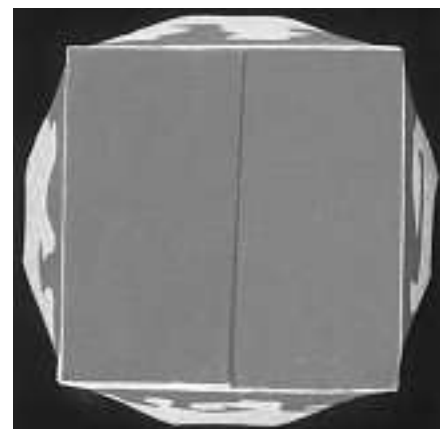

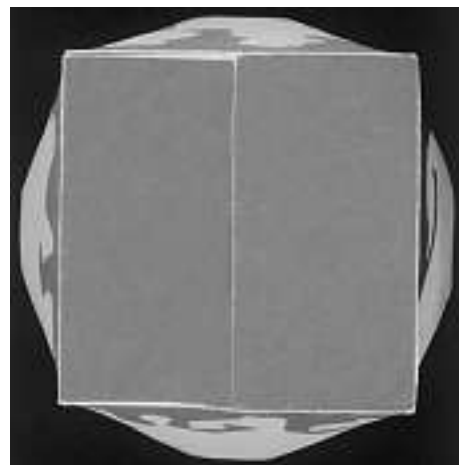

Cl. 9-03 **130 486** 25.03.2004
 1 Design – Tabletten-Dispenser
 Wyeth, Five Giralda Farms, Madison/NJ (US). Rechtsnachfolgerin der Designer Mark A. Nichols, Boston; David G. Honan, Concord und Faith C. David-Hegerich, Holliston.
 Vertr.: E. Blum & Co., Zürich
 Prior.: USA 10.10.2003

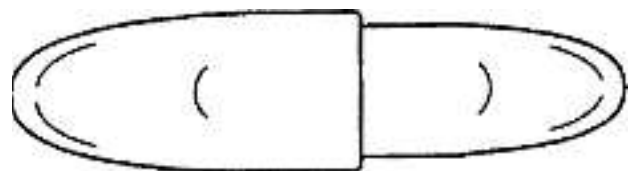
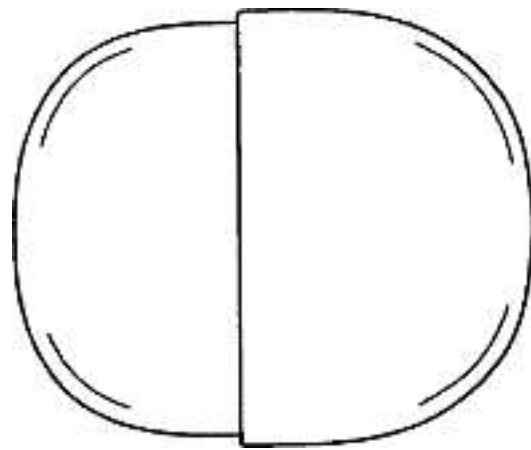
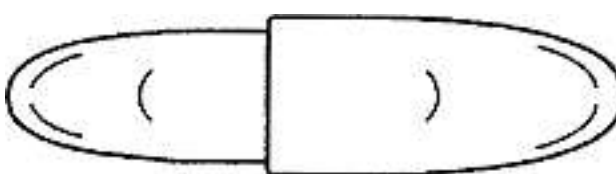
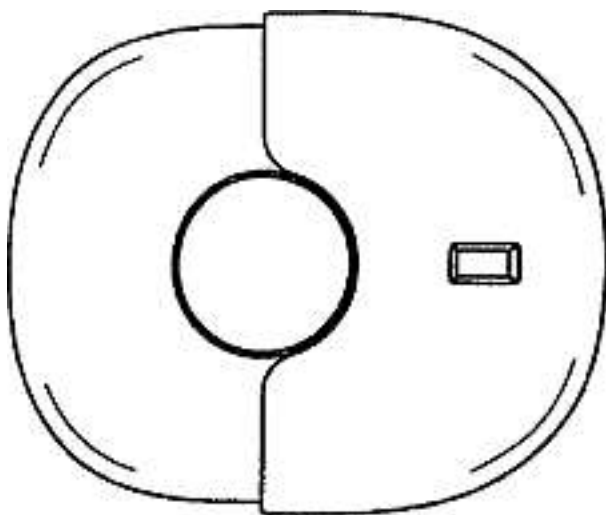
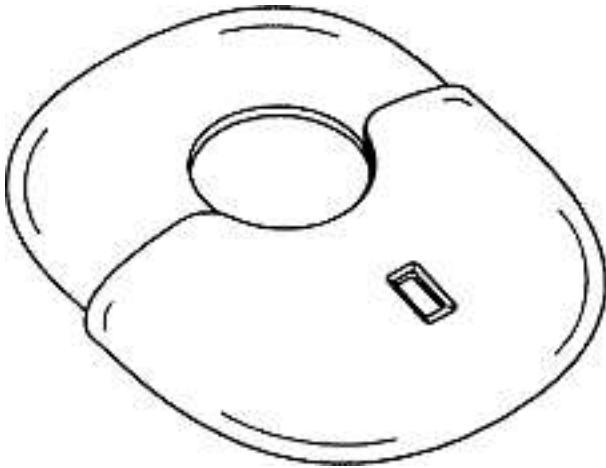

A-2004/1014

Cl. 9-05 **130 487** 19.02.2004
 1 design – ampoule
 Klaus Oechslin, Case postale 63, 1248 Hermance



Smoke-Joker

Cl. 9-05 **130 488** 24.03.2004
 2 Designs – Verpackungsmuster
 Mars, Incorporated, A Delaware Corporation, 6885 Elm Street, McLean/VA (US). Rechtsnachfolgerin der Designerin Emma Staveacre, London.
 Vertr.: A.W. Metz & Co. AG, Zürich
 Prior.: EM 07.10.2003

50896-CH-9-DB (1) (siehe Farbteil Heftmitte)

50896-CH-9-DB (2) (siehe Farbteil Heftmitte)

Cl. 9-05 **130 489** 25.03.2004
 1 Design – Verpackungsmuster
 Masterfoods AG, Baarer mattstrasse 6, 6340 Baar. Rechtsnachfolgerin des Designers Michael Foster, London.
 Vertr.: A.W. Metz & Co. AG, Zürich

8420-CH-9-DM (siehe Farbteil Heftmitte)

Cl. 10-07 **130 491** 28.01.2004
 2 designs – quadrante d'orologio
 Aphrodite Agencies Ltd, Car and Road Safety System, St. Peter / Jersey (GB). Avente causa del designer Gian-Mario Rubboli, Milano.
 Mand.: Ing. C. Gaggini, Agno

Descrizione: Caratteristiche comuni a tutti i design:
 1. Quadrante per orologio da polso indicante le maree più le fasi lunari
 2. Quadrante tinto in colori sfumati dal blu al celeste-bianco

1 (siehe Farbteil Heftmitte)

2 (siehe Farbteil Heftmitte)

Cl. 10-07 **130 492** 02.02.2004
 1 Design – Zifferblatt
 Dragutin Novosel, Bundesstrasse 1, 4054 Basel. Rechtsnachfolger des Designers Tihomir Ozvald, Karlovac

1 (siehe Farbteil Heftmitte)

Cl. 10-07 **130 493** 18.02.2004
 1 design – bracelet de montre
 Montres Fargues Sàrl, Rue de Malagny 13, Case postale 426, 1196 Gland. Ayant cause du designer Arnaud Fargues, Gland

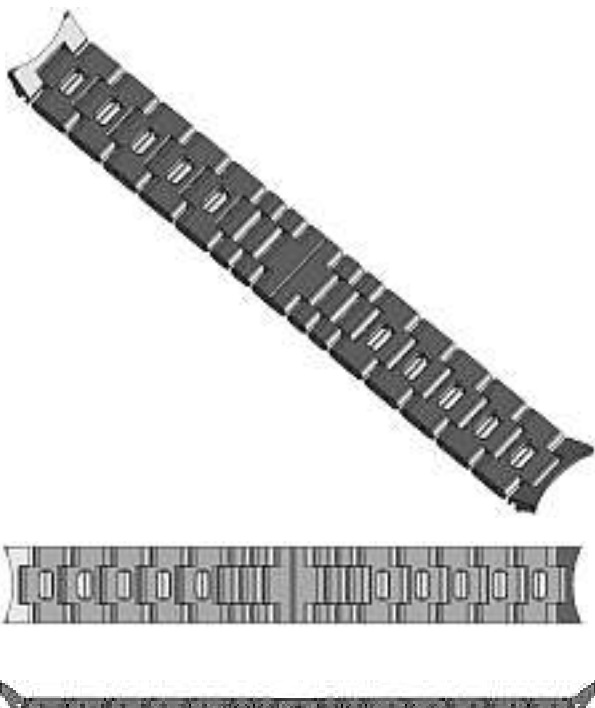

AF03

Cl. 10-07 **130 494** 01.04.2004
 4 designs – bracelet de montre, boîtier de montre
 Chaumet International S.A., 12, Place Vendôme, Paris (FR).
 Ayant cause du designer Thierry Fritsch, Paris.
 Mand.: Griffes Consulting S.A., Genève

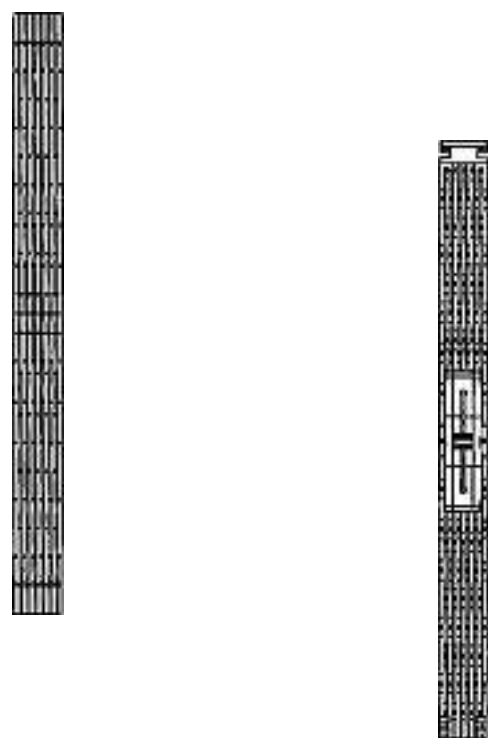
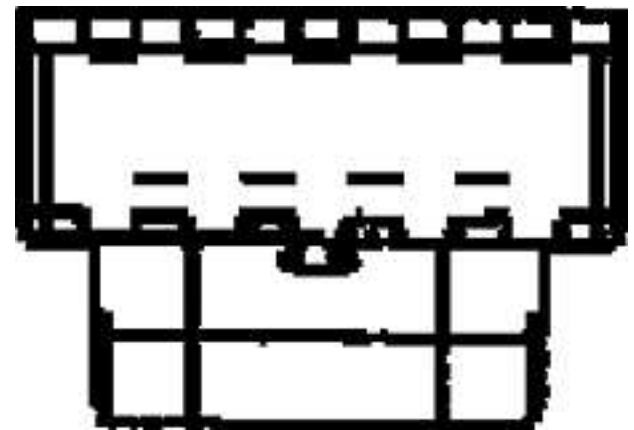
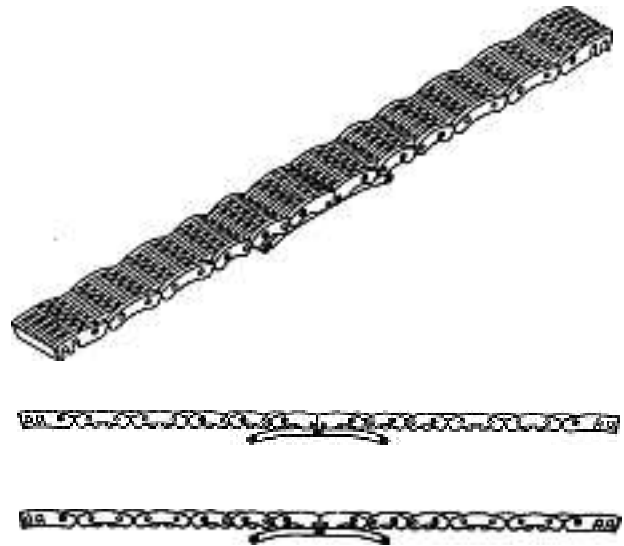



MO-69413-CH

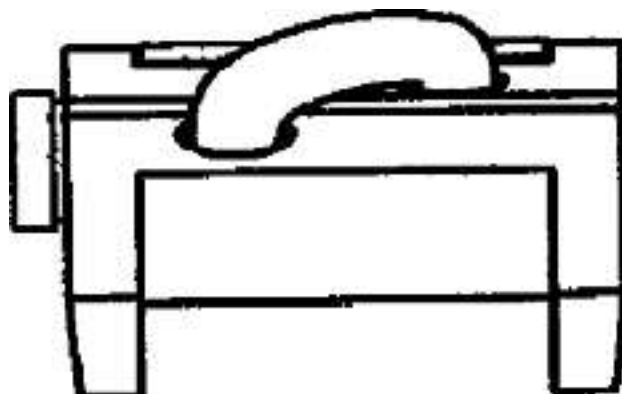
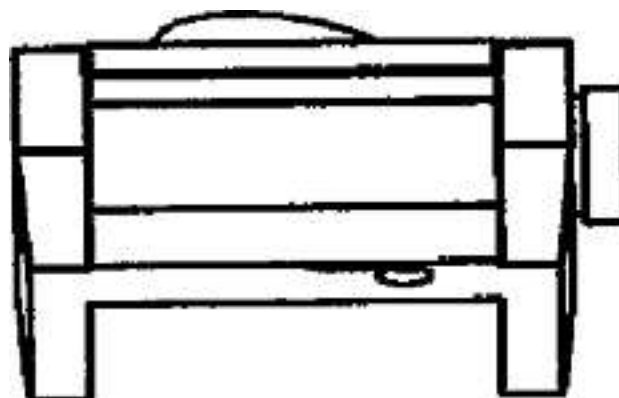
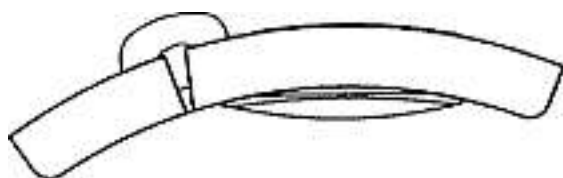
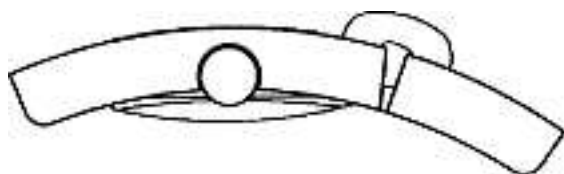
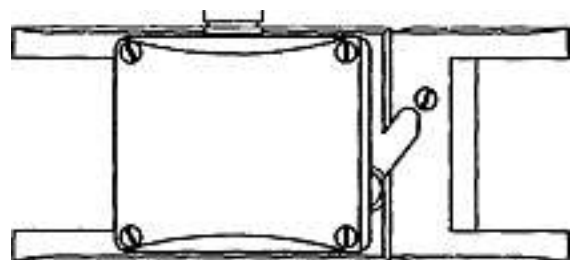
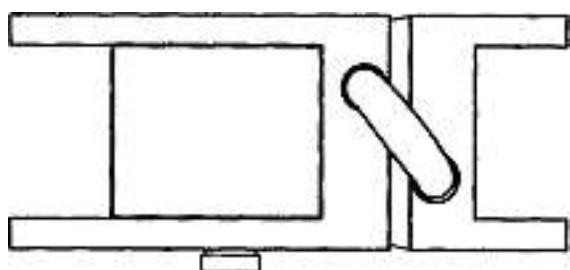
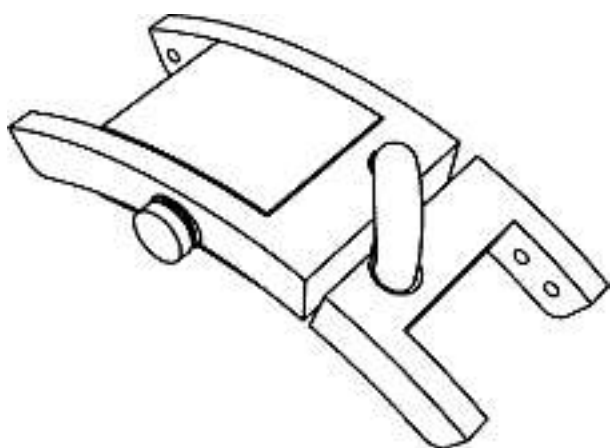

MO-69414-CH

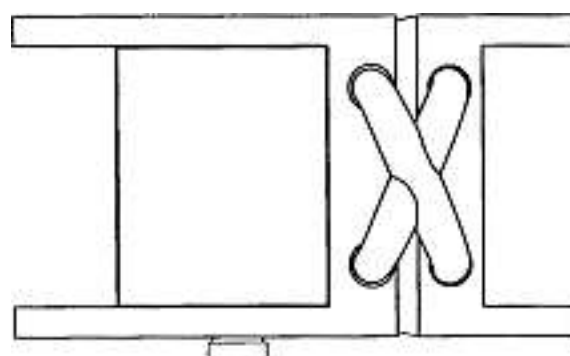
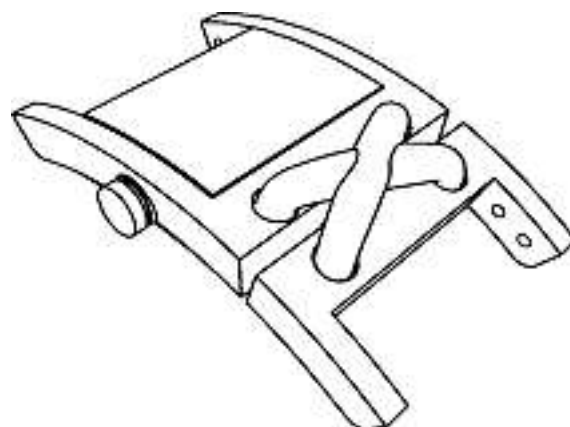

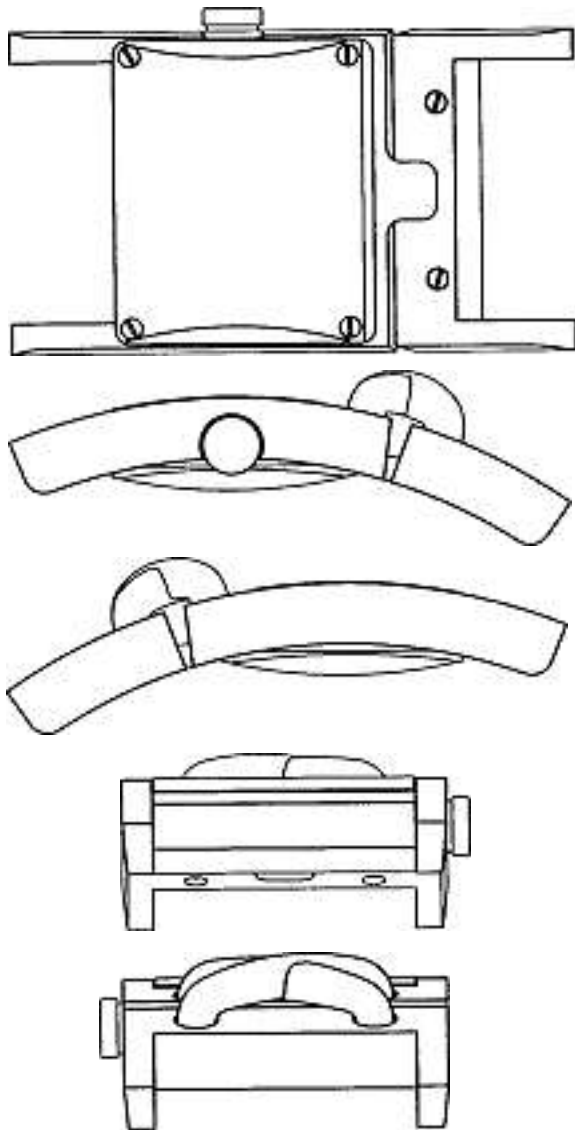

MO-69415-CH

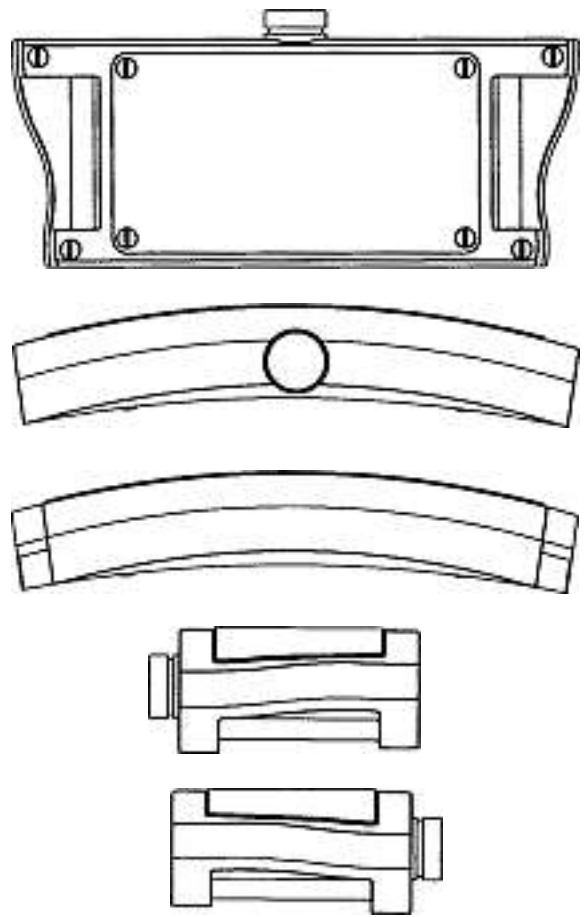

MO-69416-CH

Cl. 11-01 **130 495** 02.04.2004
 4 designs – gourmette, chevalière, pendentif
 Chaumet International S.A., 12, Place Vendôme, Paris (FR).
 Ayant cause du designer Thierry Fritsch, Paris.
 Mand.: Griffes Consulting S.A., Genève

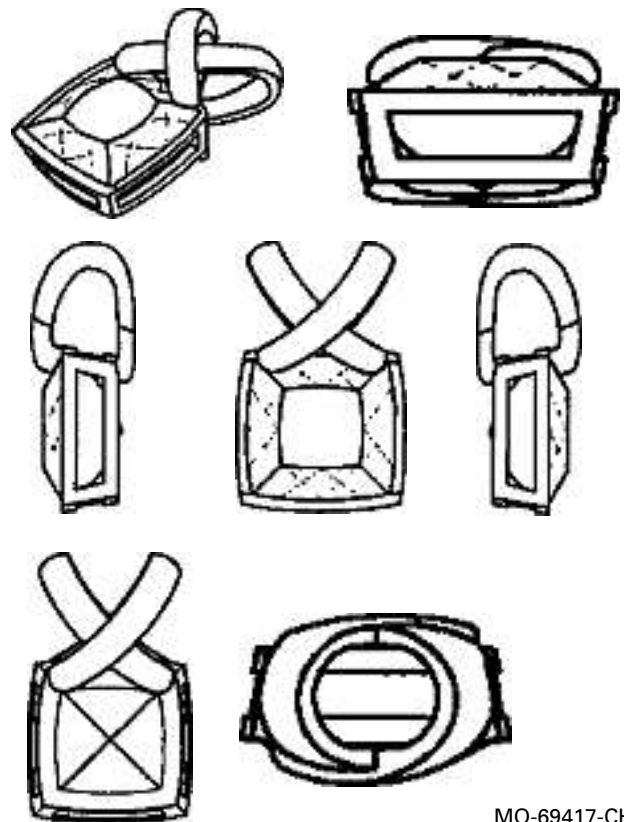
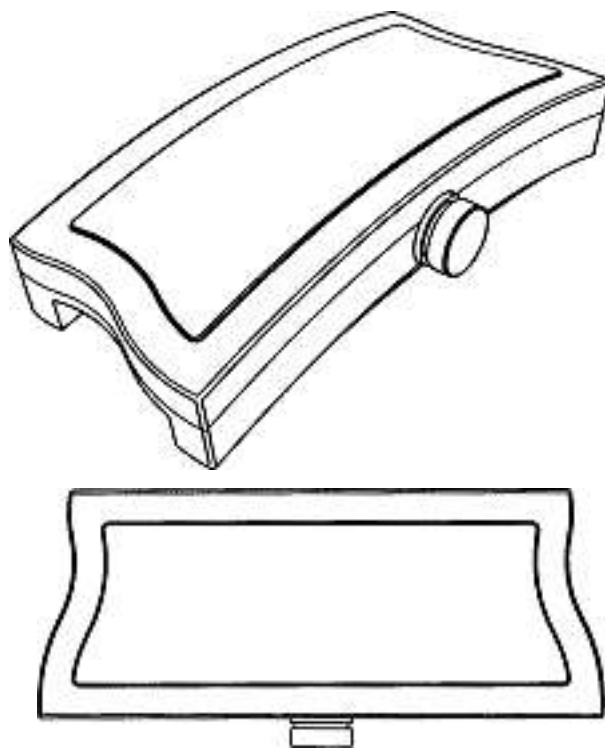

MO-69417-CH

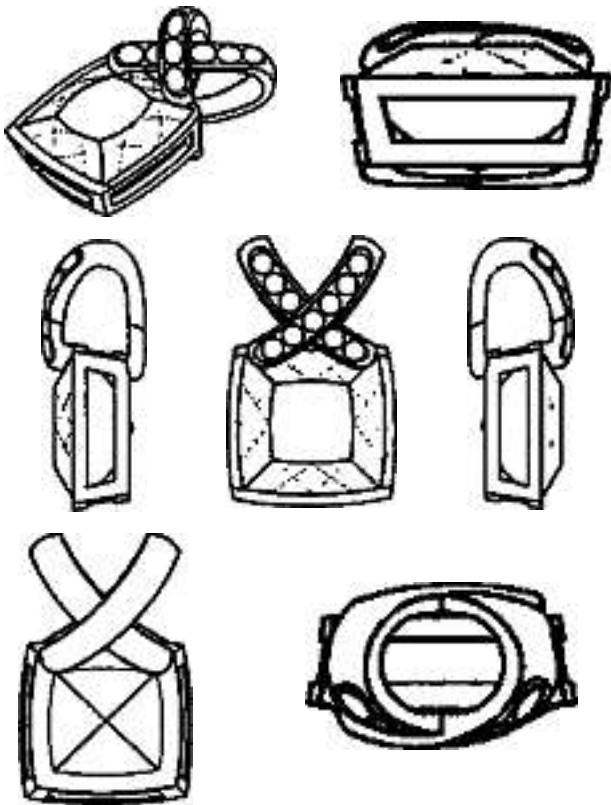

MO-69418-CH

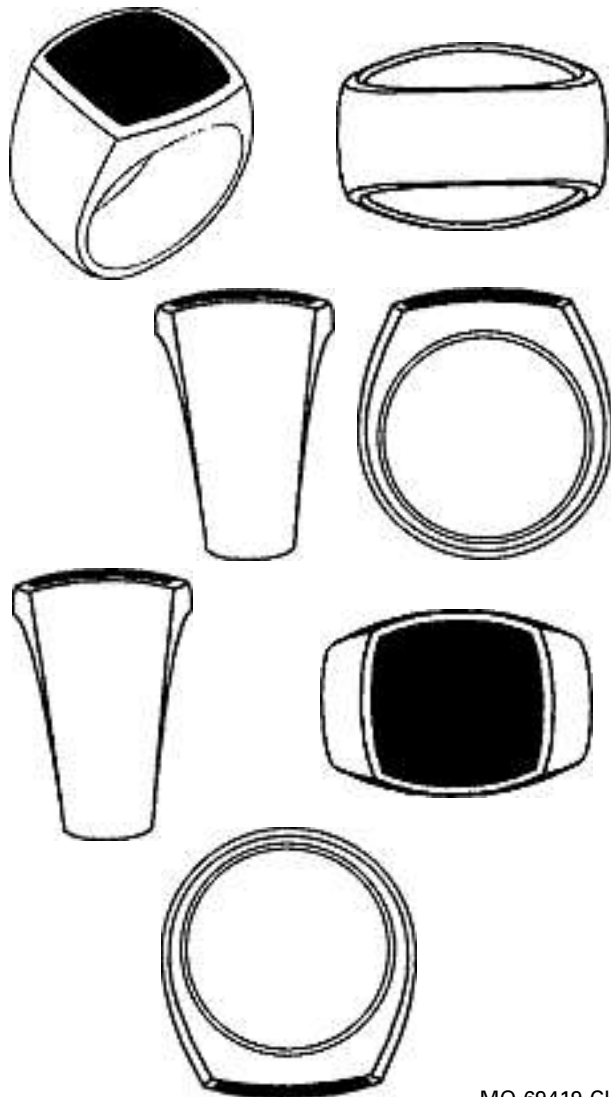

MO-69419-CH

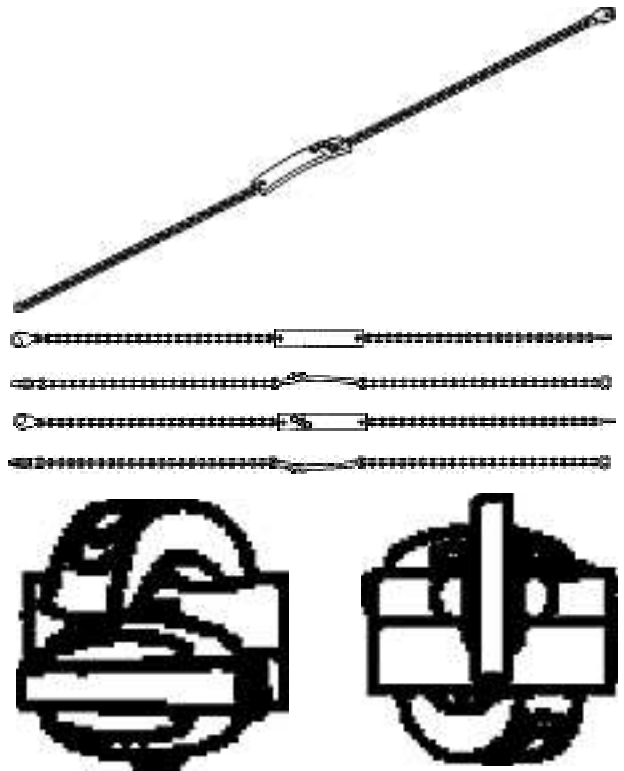

MO-69420-CH

Cl. 11-02 **130 496** 11.02.2004
 19 Designs – Vasen und Blumengefäße
 Schlittler & Co. AG, Franzosenstrasse, 6423 Seewen SZ.
 Rechtsnachfolgerin der Designer Bruno Camenzind, Gersau;
 Ivona Krurkovska, Lodz und Angelika Dörfel, Hamburg



41025



41028



41029



41030



41031



41032



41033



41041



41042



41046



41105



41109



41111



41116



41114



48012



48013



48015



48016

Cl. 12-08 130 497 18.02.2004
 1 Design – Auto
 Honda Motor Co., Ltd, No. 1-1, 2-chome, Minami-aoyama,
 Minato-ku, Tokyo (JP). Rechtsnachfolgerin der Designer
 Motoaki Minowa, Wako; Toshihiko Shibuya, Wako;
 Katsuhito Nakamura, Wako und Masashi Shimada, Wako.
 Vertr.: E. Blum & Co., Zürich
 Prior.: Japan 22.08.2003



A-2004/1005

Cl. 12-08 130 498 18.02.2004
 1 Design – Auto
 Honda Motor Co., Ltd, No. 1-1, 2-chome, Minami-aoyama,
 Minato-ku, Tokyo (JP). Rechtsnachfolgerin der Designer
 Motoaki Minowa, Wako; Toshihiko Shibuya, Wako;
 Katsuhito Nakamura, Wako und Masashi Shimada, Wako.
 Vertr.: E. Blum & Co., Zürich
 Prior.: Japan 22.08.2003





A-2004/1006

Cl. 12-16 **130 499** 18.02.2004
2 Designs – Bremszubehör
Beat Huber, Lenggasse 4, 3860 Meiringen

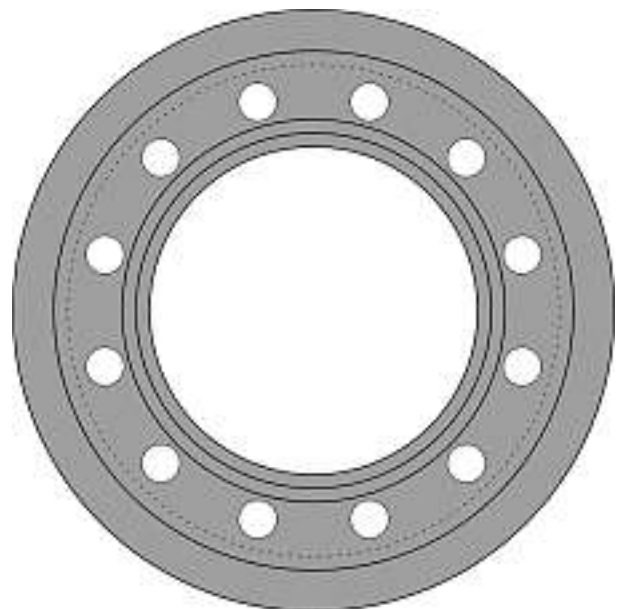

BTR001



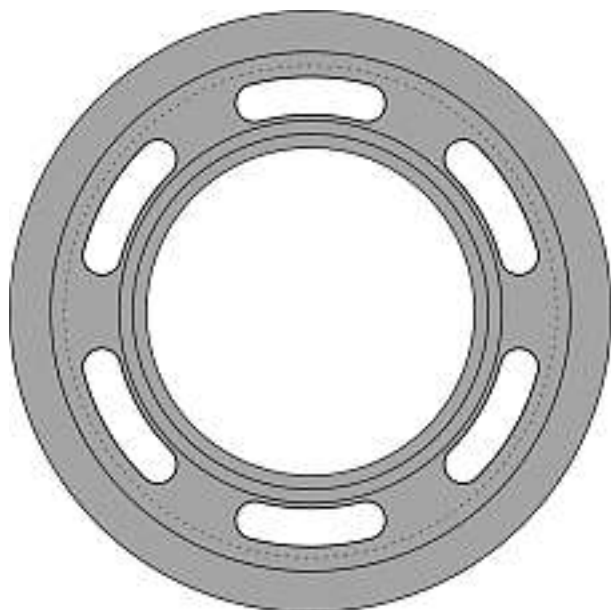
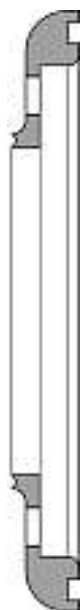

BTO002

Cl. 14-03 130 500 10.02.2004
 1 design – récepteur de radio
 British Sky Broadcasting Limited, Grant Way, Isleworth,
 Middx (GB). Ayant cause du designer Jonathan Knight,
 Londres.
 Mand.: Kirker & Cie S.A., Genève – Thônex
 Prior.: EM 10.12.2003

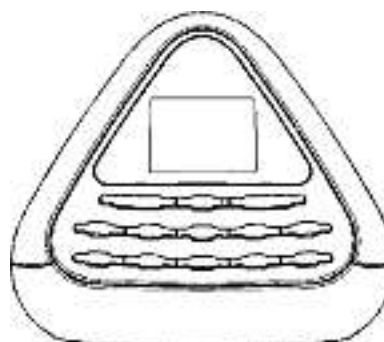

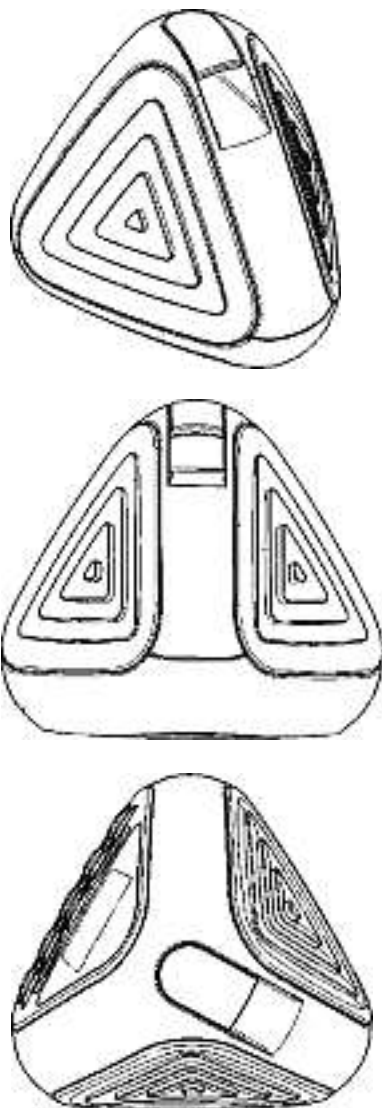

MPM/cl/308986-CH

Cl. 15-06 **130 501** 14.04.2004
 2 Designs – Maschinenverkleidung
 Trützschler GmbH & Co. KG, Duvenstrasse 82-92,
 Mönchengladbach (DE). Rechtsnachfolgerin der Designer
 Rino Bossy, Wülfrath und Armin Leder, Mönchengladbach.
 Vertr.: A. Braun, Braun, Héritier, Eschmann AG, Basel
 Prior.: Deutschland 18.10.2003

1 (siehe Farbteil Heftmitte)

2 (siehe Farbteil Heftmitte)

Cl. 15-06 **130 502** 14.04.2004
 2 Designs – Maschinenverkleidung
 Trützschler GmbH & Co. KG, Duvenstrasse 82-92,
 Mönchengladbach (DE). Rechtsnachfolgerin der Designer
 Rino Bossy, Wülfrath und Armin Leder, Mönchengladbach.
 Vertr.: A. Braun, Braun, Héritier, Eschmann AG, Basel
 Prior.: Deutschland 18.10.2003

1 (siehe Farbteil Heftmitte)

2 (siehe Farbteil Heftmitte)

Cl. 21-01 **130 503** 11.02.2004
 1 design – jeu de stratégie
 Jean-Charles Kowalski, Route des Roseires 2,
 1635 La Tour-de-Trême et Ecole d'architecture et design
 Athenaeum, Avenue Mont-d'Or 3, 1007 Lausanne. Ayant
 cause du designer Jean-Charles Kowalski, La Tour-de-Trême.
 Mand.: Jean-Charles Kowalski, La Tour-de-Trême

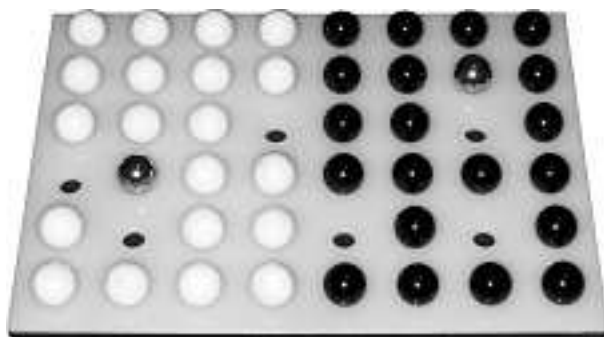

limail

Cl. 21-01 **130 504** 11.03.2004
 1 Design – Marionettenfigur
 Zugerbergbahn AG, Postfach 4864, 6304 Zug. Rechtsnach-
 folgerin der Designerin Käthi Leutwyler, Hausen a.A.

Zugiblubbi (siehe Farbteil Heftmitte)

Cl. 21-04 **130 505** 10.02.2004
 1 Design – Sonnenzelt
 Christophe Gyr, Postfach 1034, 6341 Baar und
 Roland Fischer, Zürcherstrasse 70, 8142 Uitikon.
 Vertr.: Dr. A. Rosenkranz, Spiez



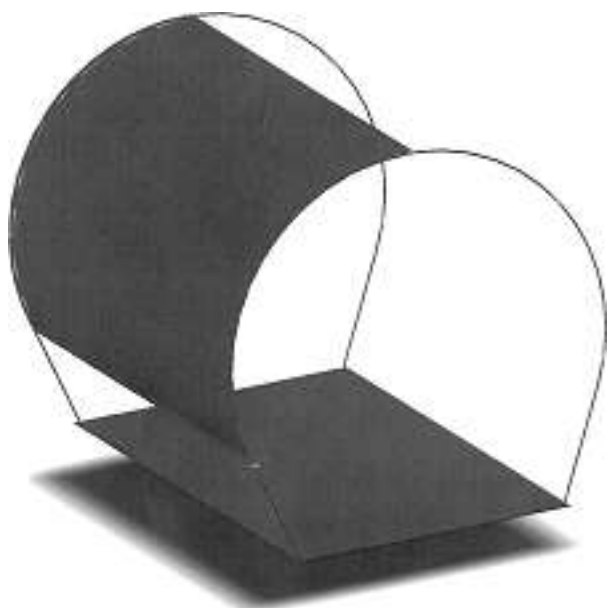

1480

Cl. 23-03 **130 506** 17.02.2004
 1 Design – Ofen
 Henk Sikken, Seemattstrasse 1, 6330 Cham

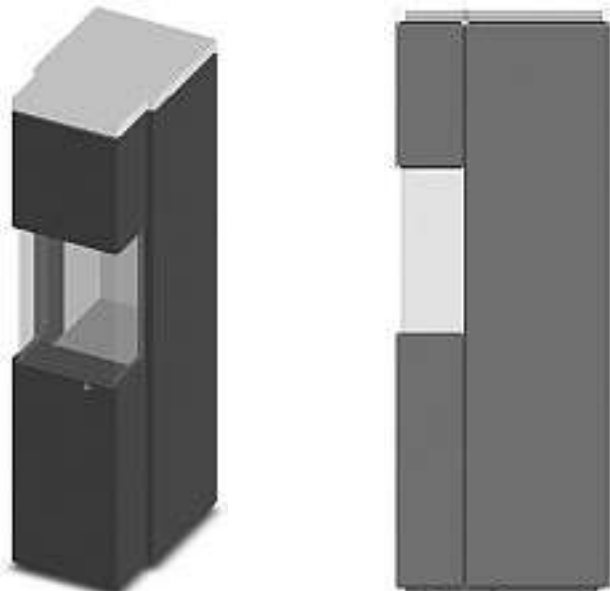

20041

Cl. 23-03 **130 507** 18.02.2004
 1 Design – Ofen
 Henk Sikken, Seemattstrasse 1, 6330 Cham.
 Rechtsnachfolger des Designers Martijn Wildekamp, Arnhem



20042

Cl. 23-03 **130 508** 19.04.2004
 3 Designs – Feuerstellen, Cheminées
 Henk Sikken, Seemattstrasse 1, 6330 Cham

- 1 (siehe Farbteil Heftmitte)
- 2 (siehe Farbteil Heftmitte)
- 3 (siehe Farbteil Heftmitte)

Cl. 25-02 **130 509** 22.03.2004
 3 Designs – Türe
 EKU AG, Wilerstrasse 90, 8370 Sirnach. Rechtsnachfolgerin
 des Designers Michael Koch, Biberist.
 Vertr.: Hans Rudolf Gachnang, Frauenfeld

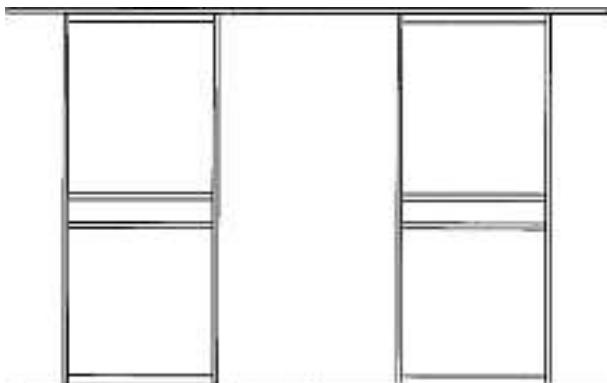

1

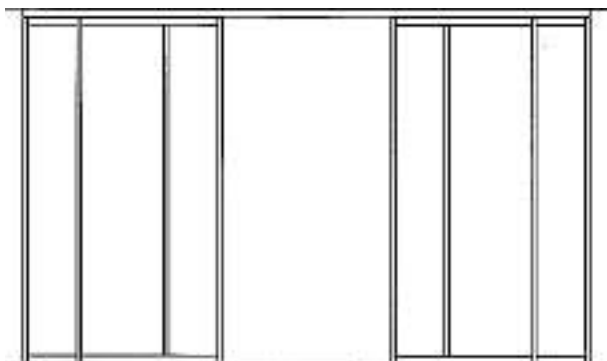

2

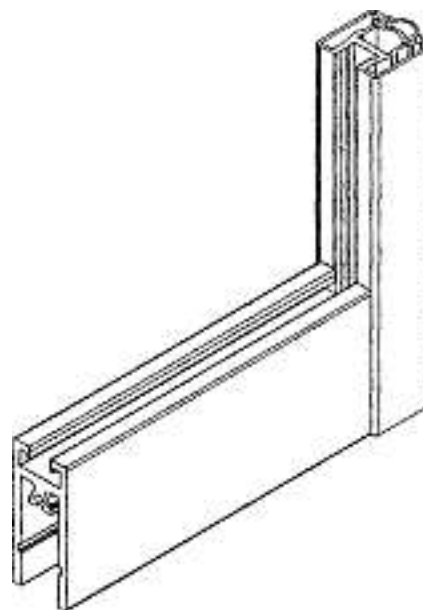
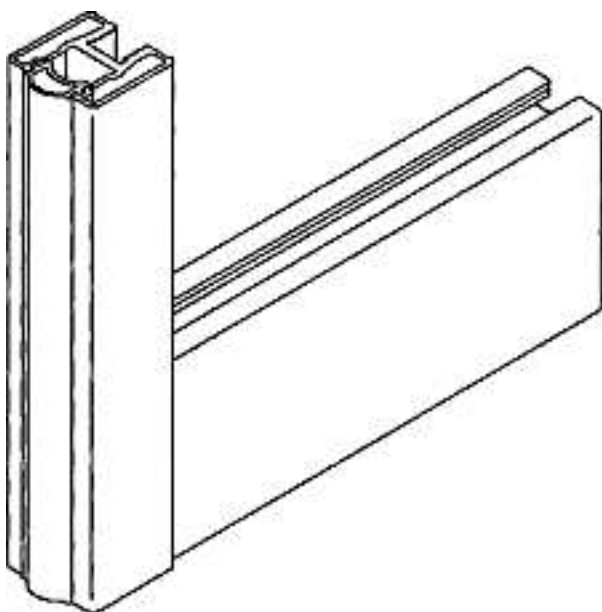

3

Cl. 26-05 **130 510** 21.01.2004
 1 Design – Pendelleuchte
 Neue Werkstatt GmbH, Oberer Deutweg 1, 8400 Winterthur.
 Rechtsnachfolgerin der Designer Andreas Giupponi,
 Zürich; Christoph Dietlicher, Zürich und Thomas Drack,
 Winterthur

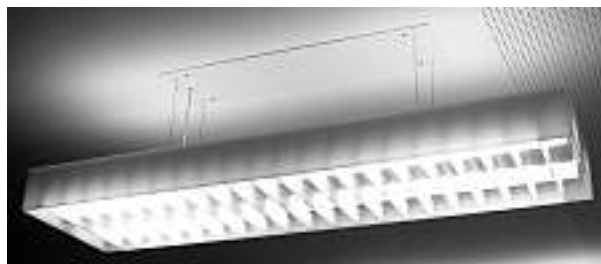

Le31 Max

Cl. 26-06 **130 511** 18.02.2004
 2 Designs – Front- und Hecklampe für Automobile
 Honda Motor Co., Ltd, No. 1-1, 2-chome, Minami-aoyama,
 Minato-ku, Tokyo (JP). Rechtsnachfolgerin der Designer
 Eri Nakai, Wako und Hideto Kubota, Wako.
 Vertr.: E. Blum & Co., Zürich
 Prior.: Japan 22.08.2003, 22.08.2003

A-2004/1004a (siehe Farbteil Heftmitte)

A-2004/1004b (siehe Farbteil Heftmitte)

Cl. 28-01 **130 512** 11.03.2004
 5 Designs – Kapseln und Tabletten
 Novartis AG, Lichtstrasse 35, 4056 Basel. Rechtsnach-
 folgerin der Designer Jean-Daniel Bonny, Füllinsdorf;
 Stefan Hirsch, Lörrach; Oskar Kalb, Lörrach und
 Peter Pietzonka, Maisprach.
 Vertr.: Novartis AG, Corporate Intellectual Property, Basel
 Prior.: EM 16.09.2003

4-33435A/DES-1 (siehe Farbteil Heftmitte)

4-33435A/DES-2 (siehe Farbteil Heftmitte)

4-33435A/DES-3 (siehe Farbteil Heftmitte)

4-33435A/DES-4 (siehe Farbteil Heftmitte)

4-33435A/DES-5 (siehe Farbteil Heftmitte)

Cl. 28-03 130 513 17.03.2004
 1 design – serre-tête
 Emmanuelle de Riedmatten, rue du Bourg de Plaît 10,
 1071 Chexbres

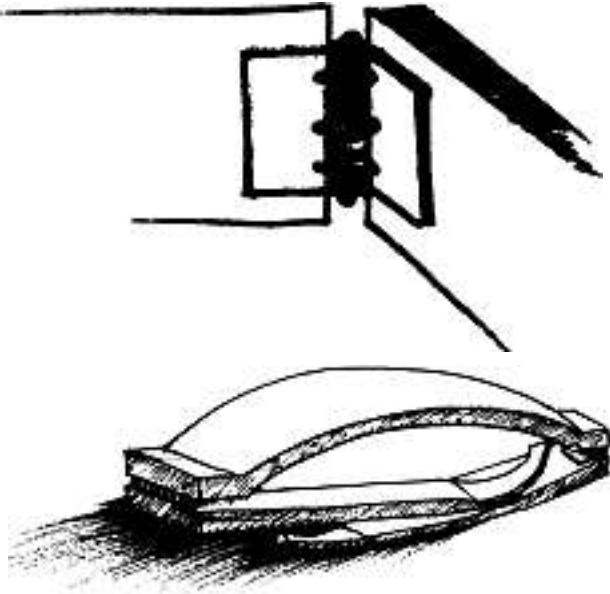

326954

Cl. 99-00 130 514 12.02.2004
 2 Designs – Urnen
 mass-massenware schär & co, Schwandenholzstrasse 186A,
 8046 Zürich. Rechtsnachfolgerin des Designers
 Thomas Schär, Zürich



cosmiccolours / jembele



mokkyu

**Verlängerungen
 Prolongations
 Prolongazioni**

117 339 Cl. 8-08 1 design

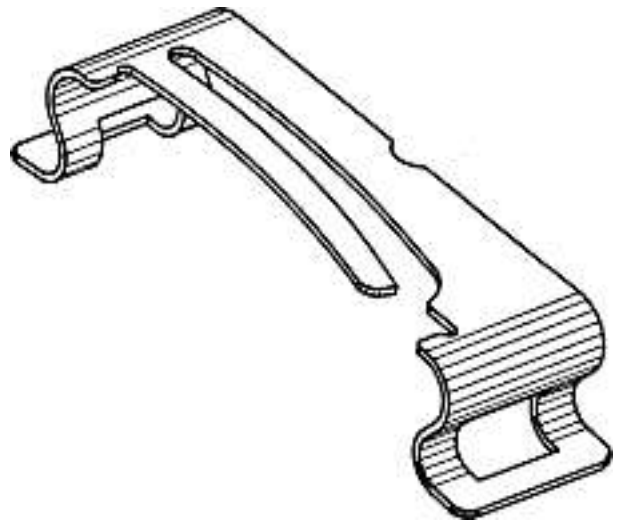

1

121 301	Cl.	12-11	1 Design
121 434	Cl.	22-01	1 design
121 461	Cl.	7-05	2 designs
121 509	Cl.	11-01	5 Designs
125 983	Cl.	6-01	3 Designs
126 066	Cl.	9-03	1 Design
126 114	Cl.	12-15	1 Design
126 115	Cl.	12-15	1 Design
126 121	Cl.	16-06	2 Designs
126 238	Cl.	11-01	1 Design

**Mutationen
 Modifications
 Modificazioni**

128 669

Übertragung an: Elisabeth Griess, Haldenrain 6, 6006 Luzern

Löschungen
Radiations
Radiazioni

116 951	Cl.	7-02	1 design
116 965	Cl.	15-07	1 Design
116 970	Cl.	26-02	1 Design
116 986	Cl.	10-01	1 design
120 779	Cl.	20-02	1 Design
120 790	Cl.	7-02	1 Design
120 792	Cl.	9-01	2 Designs
120 800	Cl.	10-07	1 Design
120 810	Cl.	20-02	2 Designs
120 816	Cl.	24-02	2 Designs
120 817	Cl.	2-02	103 Designs
125 422	Cl.	6-03	2 Designs
125 424	Cl.	8-01	1 Design
125 430	Cl.	11-02	1 Design
125 442	Cl.	3-01	2 Designs
125 444	Cl.	6-01	1 design
125 448	Cl.	6-04	1 design
125 452	Cl.	9-03	1 design
125 453	Cl.	9-03	1 design
125 455	Cl.	9-05	1 design
125 456	Cl.	10-02	1 design
125 457	Cl.	11-01	7 Designs
125 458	Cl.	11-02	1 Design
125 459	Cl.	12-08	1 Design
125 460	Cl.	12-14	4 Designs
125 461	Cl.	12-16	7 Designs
125 471	Cl.	20-03	3 Designs
125 473	Cl.	21-01	10 designs
125 474	Cl.	21-01	6 designs
125 477	Cl.	23-01	1 design
125 498	Cl.	9-03	4 designs
125 585	Cl.	14-03	1 Design

Cl. 2-06

130 464

17.03.2004



57966 CH

Farbteil 1

Cl. 9-01

130 482

28.01.2004





D 4265



50896-CH-9-DB (2)

Cl. 9-05 130 489 25.03.2004



8420-CH-9-DM

Cl. 9-05 130 488 24.03.2004



50896-CH-9-DB (1)

Cl. 10-07 130 491 28.01.2004



1



2

Cl. 10-07

130 492

02.02.2004

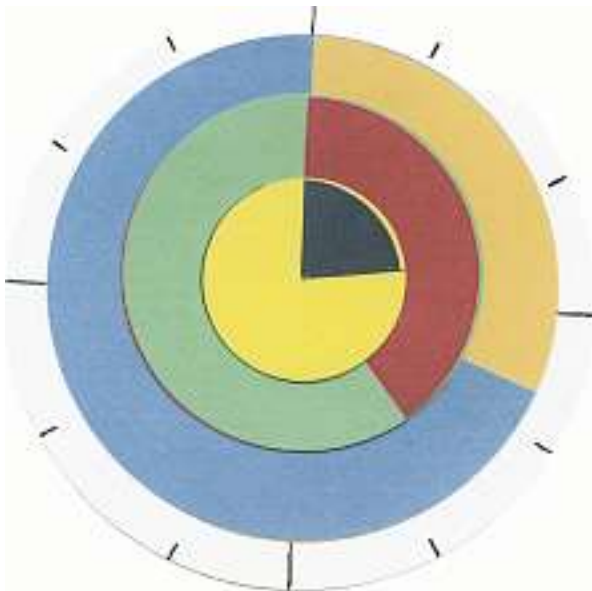

1

Cl. 15-06

130 501

14.04.2004



1

Farbteil 3

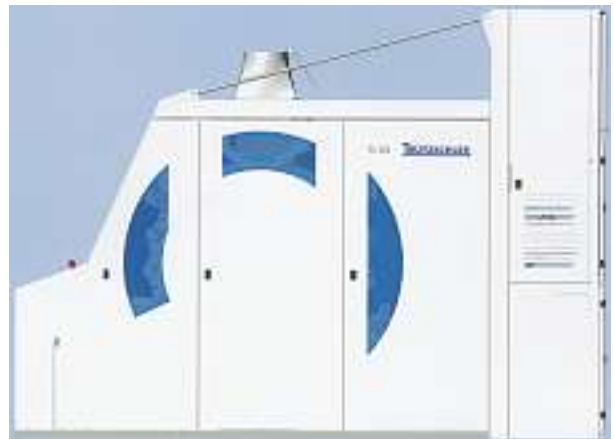



2

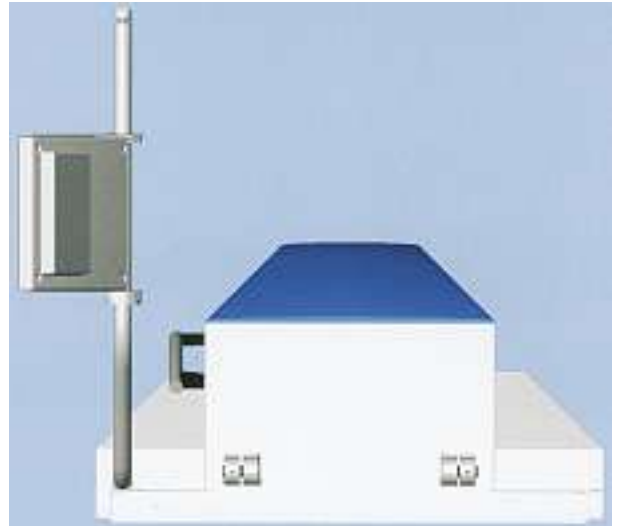

2

Cl. 15-06

130 502

14.04.2004



1



Cl. 21-01

130 504

11.03.2004



Zugiblubbi

Cl. 23-03

130 508

19.04.2004



1



2



3



Cl. 26-06

130 511

18.02.2004



A-2004/1004a





A-2004/1004b

Cl. 28-01

130 512

11.03.2004

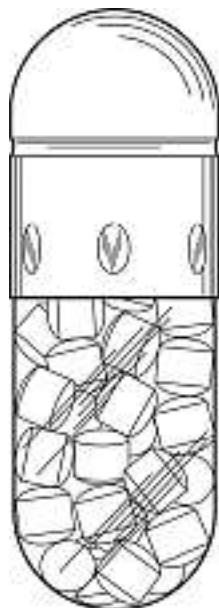

4-33435A/DES-1



4-33435A/DES-2

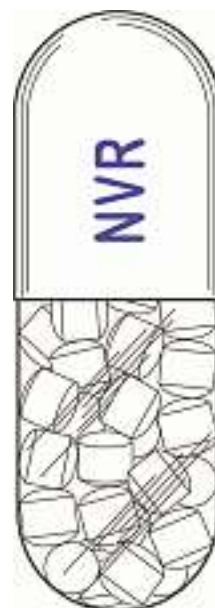

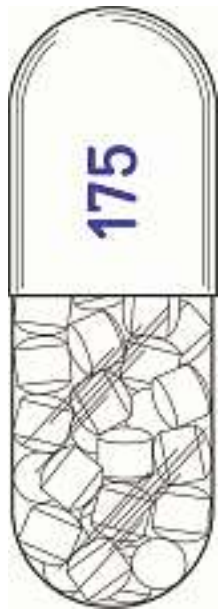

4-33435A/DES-3



4-33435A/DES-4

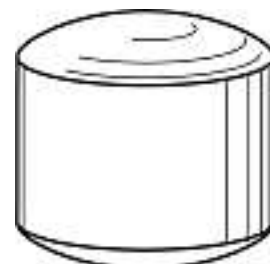
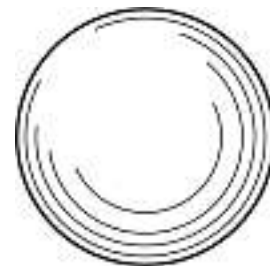
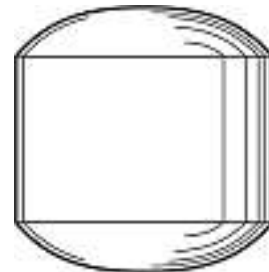

4-33435A/DES-5