

Nationale Hinterlegungen

In der folgenden Liste werden die beim Eidgenössischen Institut für Geistiges Eigentum hinterlegten Designs publiziert. Dabei sind der Reihe nach angegeben:

- internationale Klassenangaben
- Hinterlegungsnummer
- Hinterlegungsdatum
- Allenfalls Aufschub der Veröffentlichung
- Anzahl der hinterlegten Designs
- Bezeichnung
- Name und Wohnsitz des Hinterlegers oder der Hinterlegerin
- gegebenenfalls Name und Wohnsitz des Designers oder der Designerin
- Name und Geschäftssitz des allfälligen Vertreters oder der Vertreterin
- gegebenenfalls Prioritätsangaben
- gegebenenfalls Beschreibungstext
- Ordnungsnummer
- Reproduktion des Designs

Internationale Hinterlegungen

Die bei der Weltorganisation für geistiges Eigentum in Genf hinterlegten Muster und Modelle mit Benennung Schweiz geniessen den gleichen Schutz wie national hinterlegte Designs. Sie werden jeweils im Blatt «Bulletin des dessins et modèles internationaux» veröffentlicht. Dieses Publikationsorgan ist deshalb für eine vollständige Recherche unbedingt beizuziehen.

Topographien

Angaben über die vom Eidgenössischen Institut für Geistiges Eigentum eingetragenen Topographien von Halbleitererzeugnissen werden in folgender Anordnung aufgeführt:

- Eintragsnummer
- Anmeldedatum
- Bezeichnung
- Name und Wohnsitz des Anmelders oder der Anmelderin
- gegebenenfalls Name und Wohnsitz des Herstellers oder der Herstellerin
- Name und Geschäftssitz des oder der allfälligen Bevollmächtigten
- Datum und Ort einer allfälligen ersten geschäftlichen Verbreitung der Topographie

Dépôts nationaux

Les designs déposés à l'Institut Fédéral de la Propriété Intellectuelle sont publiés dans la liste qui suit. Les indications y relatives sont mentionnées dans cet ordre:

- indications des classes internationales
- numéro de dépôt
- date de dépôt
- le cas échéant, ajournement de la publication
- nombre des designs déposés
- désignation
- nom et domicile du/de la déposant/e
- le cas échéant, nom et domicile du/de la designer
- nom et domicile de l'éventuel/le mandataire
- le cas échéant, indication de priorité
- le cas échéant, description du design
- numéro attribué à chaque design
- reproduction du design

Dépôts internationaux

Les dessins et modèles déposés à l'Organisation Mondiale de la Propriété Intellectuelle à Genève qui désignent la Suisse jouissent de la même protection que les dépôts nationaux. Ils sont chaque fois publiés dans la feuille «Bulletin des dessins et modèles internationaux». Pour une recherche complète, il est indispensable de consulter ledit organe de publication.

Topographies

Les indications concernant les topographies des produits semi-conducteurs, enregistrées par l'Institut Fédéral de la Propriété Intellectuelle, sont énumérées dans l'ordre suivant:

- numéro d'enregistrement
- date de dépôt
- désignation
- nom et domicile du/de la déposant/e
- le cas échéant, nom et domicile du/de la producteur/trice
- nom et domicile de l'éventuel/le mandataire
- date et lieu d'une éventuelle première mise en circulation de la topographie

Depositi nazionali

Nella lista seguente vengono pubblicati i design depositati presso l'Istituto Federale della Proprietà Intellettuale. Sono menzionati nel seguente ordine:

- indicazioni delle classi internazionali
- numero di deposito
- data del deposito
- se del caso, indicazione che la pubblicazione è stata differita
- numero dei design depositati
- designazione
- nome e domicilio del depositante
- se del caso, nome e domicilio del designer
- nome e sede di un eventuale mandataro
- se del caso, indicazioni di priorità
- se del caso, descrizione del design
- numero d'ordine
- riproduzione del design

Depositi internazionali

I disegni e modelli depositati presso l'Organizzazione Mondiale della Proprietà Intellettuale a Ginevra con denominazione Svizzera godono della medesima protezione del deposito nazionale. Essi vengono pubblicati ogni volta nel foglio «Bulletin des dessins et modèles internationaux». Quest'organo di pubblicazione è da consultare se si vuole effettuare una ricerca completa.

Topografie

Le indicazioni concernenti le topografie di prodotti a semiconduttori depositati presso l'Istituto Federale della Proprietà Intellettuale sono menzionate nell'ordine seguente:

- numero di registrazione
- data del deposito
- designazione
- nome e domicilio del/la richiedente
- se del caso, nome e domicilio del/la produttore/trice
- nome e sede di un eventuale mandataro
- data e luogo di un'eventuale prima messa in circolazione della topografia

Hinterlegungen
Dépôts
Depositi

Cl. 01-01 130 699 05.05.2004
4 design – grissini
Depositante: Barilla Alimentare S.p.A., Via Mantova 166,
Parma, IT
Designer: Ernesto Buriani, Parma; Andrea Cavatorta, Parma;
Luigi Coscia, Parma; Marco Giovanetti, Parma
Mandatario: M. ZARDI & CO. S.A., 6900 Lugano
Priorità: EM, 07.11.2003

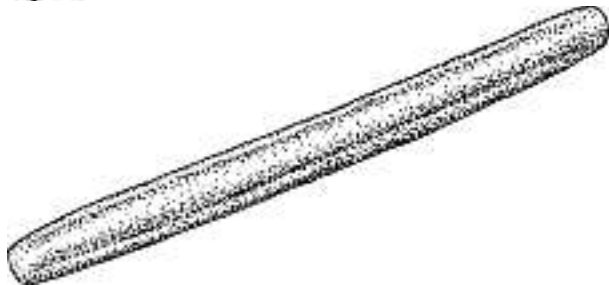
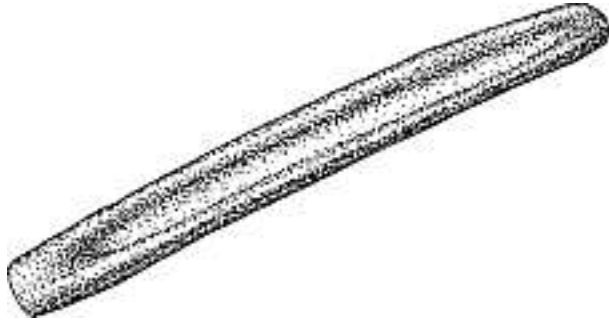

1

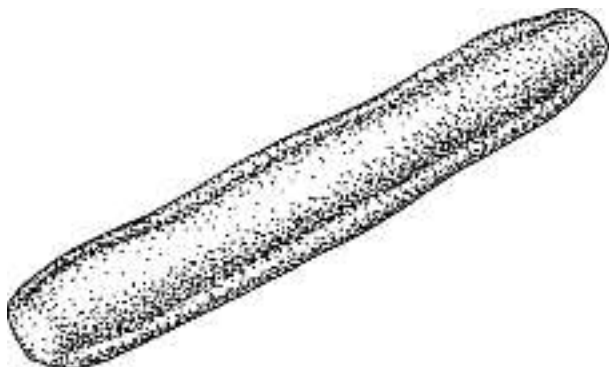
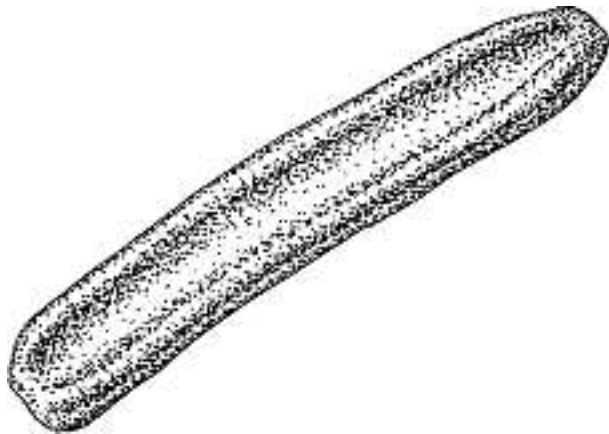

2

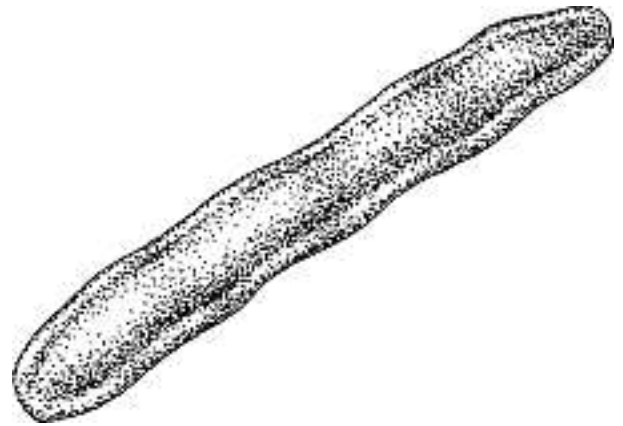
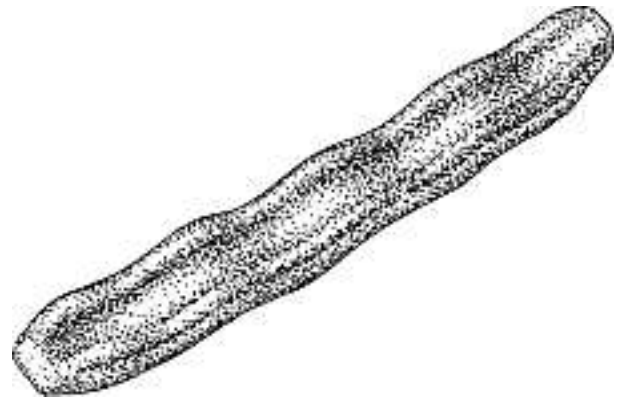

3

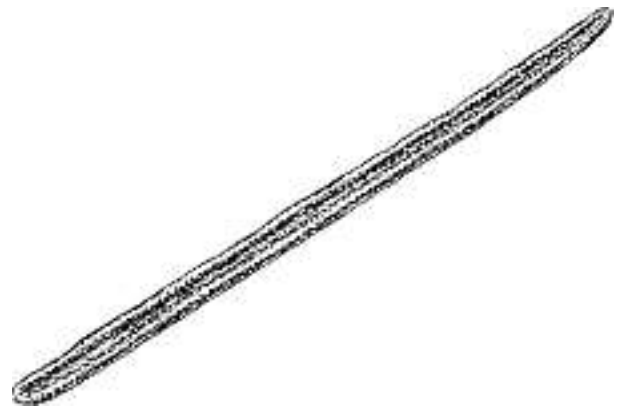

4

Cl. 02-03 130 700 15.04.2004
 21 design – bonnets
 Déposant: Eisbär Sportmoden GmbH, Hauptstrasse 15,
 4101 Feldkirchen, AT
 Designer: Susanna Wöss, Feldkirchen
 Mandataire: Cabinet Roland Nithardt, Conseils en Propriété
 Industrielle SA, 1400 Yverdon-les-Bains
 Priorité: AT, 12.11.2003; AT, 30.01.2004



1



2



3



4



5



6



7



8



9



10



11



12



13



14



15



16



17



18



19



20





21

Cl. 03-01 **130 701** 07.05.2004
3 design – valises
Déposant: PARAT-Werk Schönenbach GmbH & Co. KG,
Tenter Weg 1-3, Remscheid, DE
Designer: Heinrich Schönenbach, Remscheid
Mandataire: Moins & Savoye S. A., 1201 Genève
Priorité: EM, 11.11.2003





O001.121/1



O001.121/2





O001.121/3



Cl. 03-01 130 702 10.05.2004
2 Design – Taschen
Hinterleger: Christian Kirmann, Unterlindig, 6206 Neuenkirch



2

Cl. 03-01 130 703 14.05.2004
 1 Design – Rucksack-Tasche
 Hinterleger: Ineke Buchs, Länggassstrasse 77, 3012 Bern



tulu

Cl. 03-01 130 704 14.05.2004
 1 Design – Werkzeugkoffer
 Hinterleger: Hardware Industrial Manufacturing S.r.l.,
 Via dei Bravi, 6, 23868 Valmadrera, (Lecco), IT
 Designer: Andrea Colombo, Valmadrera
 Vertreter: Patentanwälte, Schaad, Balass, Menzl & Partner AG,
 8034 Zürich
 Priorität: EM, 18.12.2003

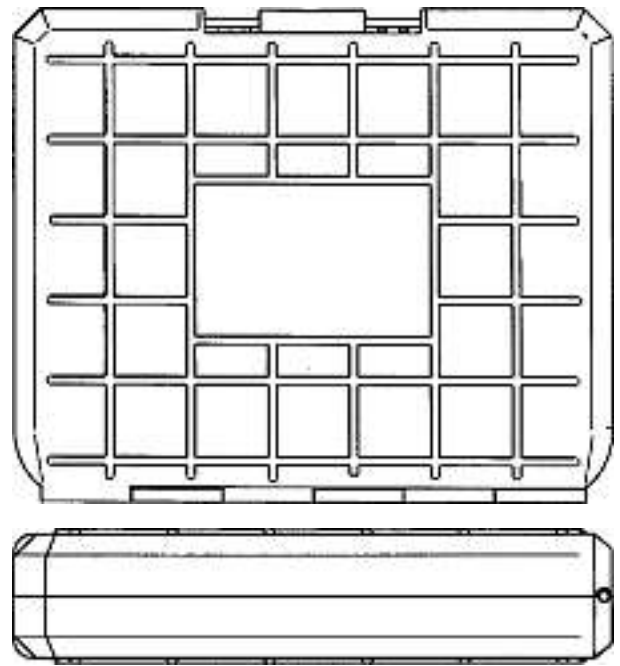
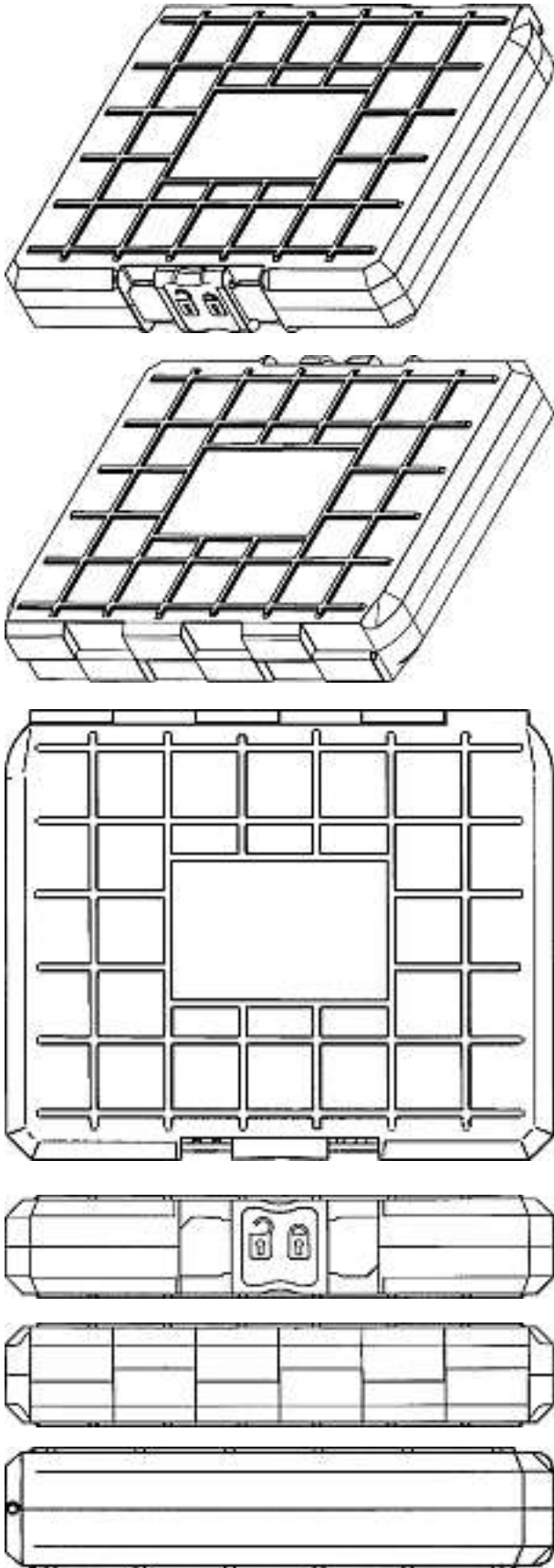

D 494 CH

Cl. 05-05 130 705 27.04.2004
 9 Design – Aufdrucke für Textilien
 Hinterleger: Maly + Wörfel GmbH, Behringstrasse 7,
 Herrenberg, DE
 Designer: Günter Wörfel, Aidlingen
 Vertreter: ABACUS Patentanwälte, Klocke Späth Barth,
 8134 Adliswil
 Priorität: DE, 05.11.2003

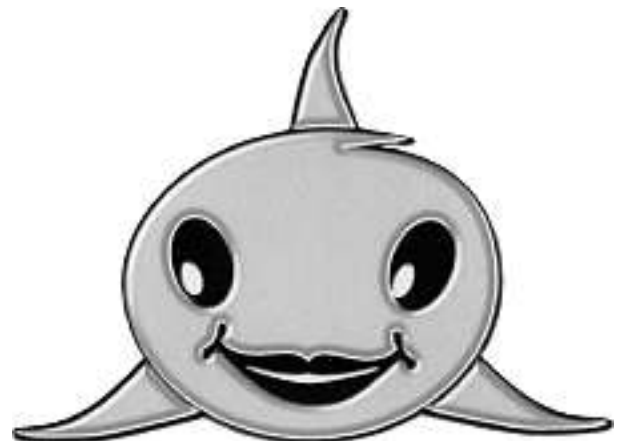

Fisch

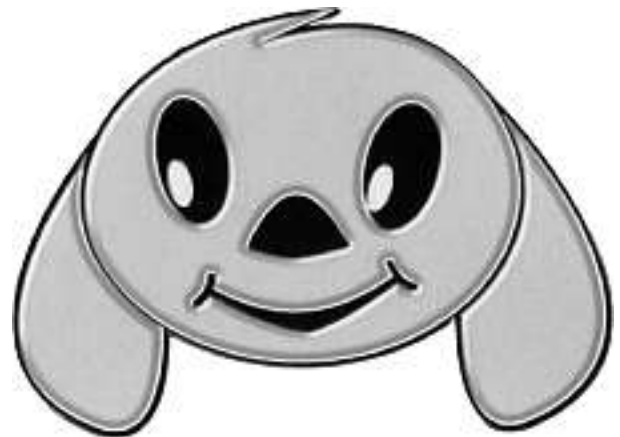

Hund

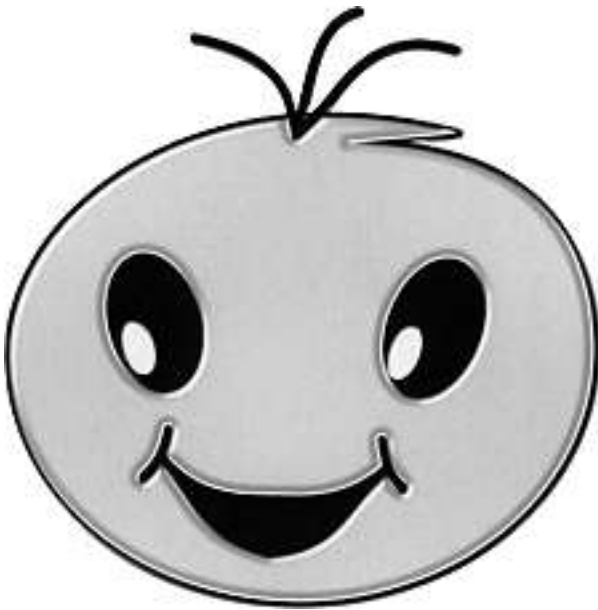

Junge



Mädchen

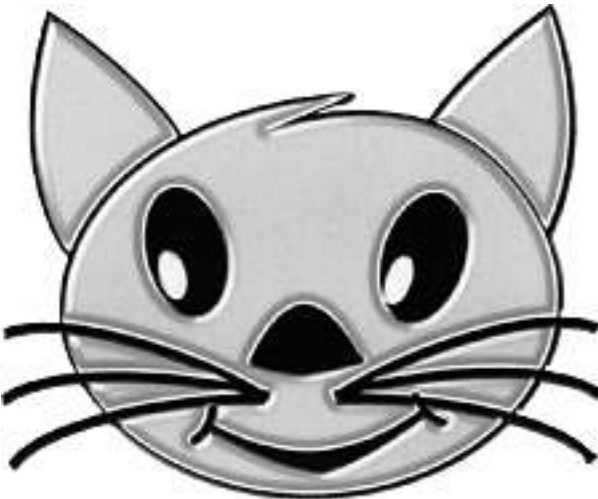

Katze

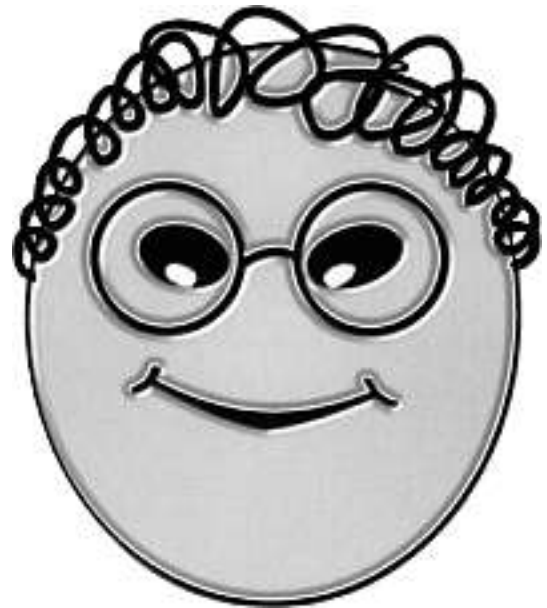

Oma



Mama



Opa



Papa

Cl. 06-01 130 706 30.04.2004

1 Design – Stuhl
Hinterleger: Vitra Patente AG, Klünenfeldstrasse 22,
4132 Muttenz
Designer: Maarten Van Severen, Gent
Vertreter: AXON Patent GmbH, 4147 Aesch





Cl. 06-01 130 707 10.05.2004
5 Design – Stühle
Hinterleger: Kokuyo Co., Ltd, 1-1, Oimazato Minami 6-chome,
Higashinari-ku/Osaka-shi/Osaka, JP
Designer: Yojiro Kinoshita, Osaka; Kenji Teshima, Osaka;
Fritz Frenkler, Frankfurt am Main
Vertreter: Bovard AG, 3000 Bern 25
Priorität: JP, 12.11.2003; JP, 12.11.2003; JP, 12.11.2003

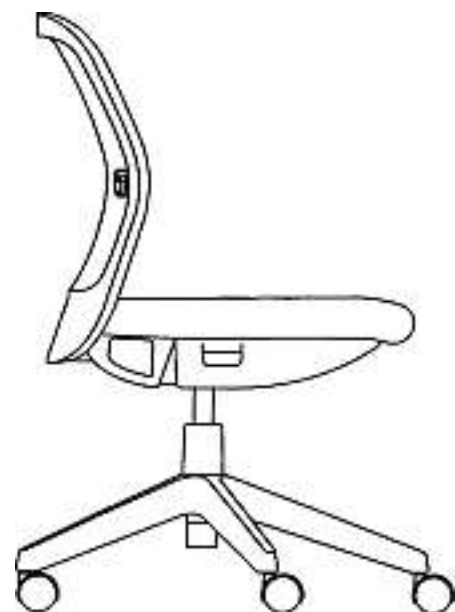
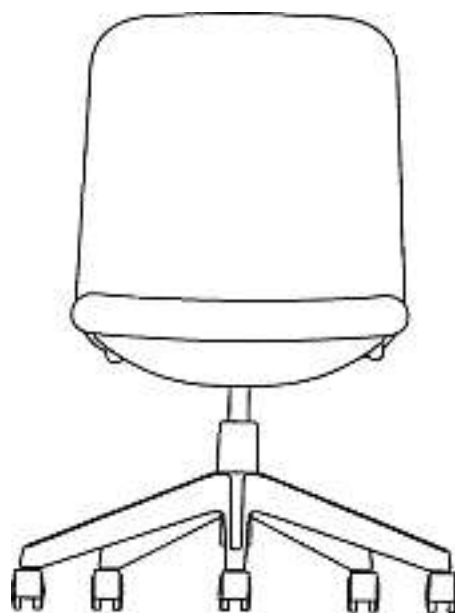

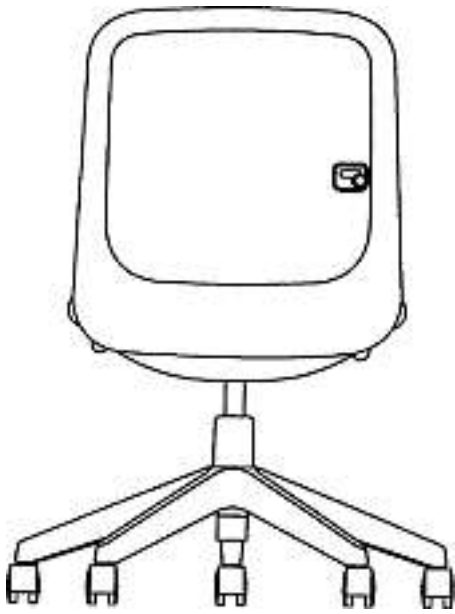

300388/1

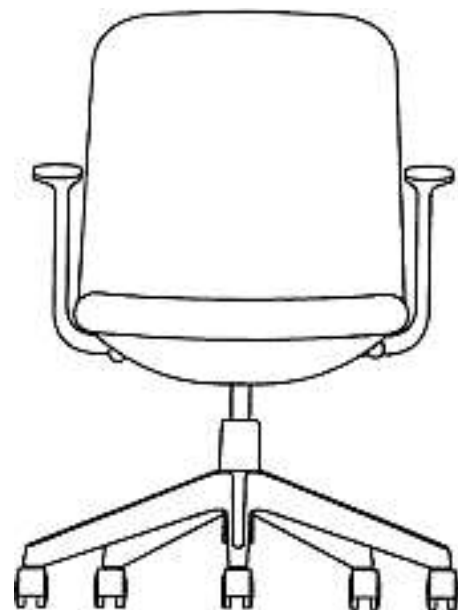
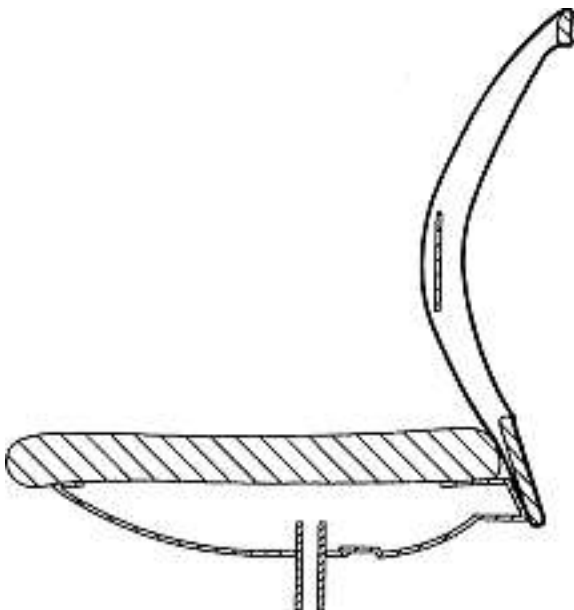

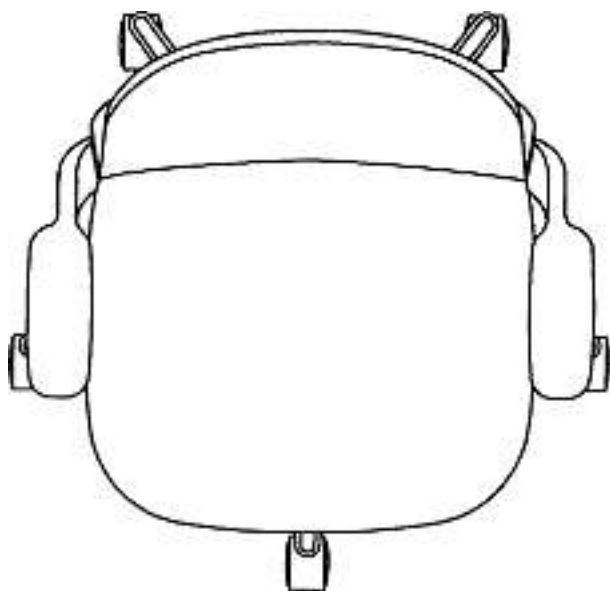
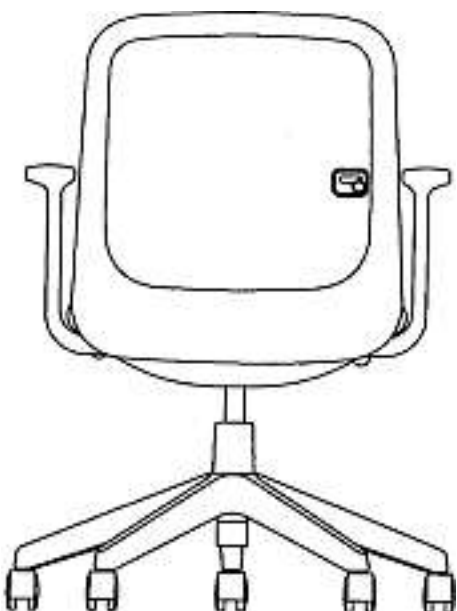
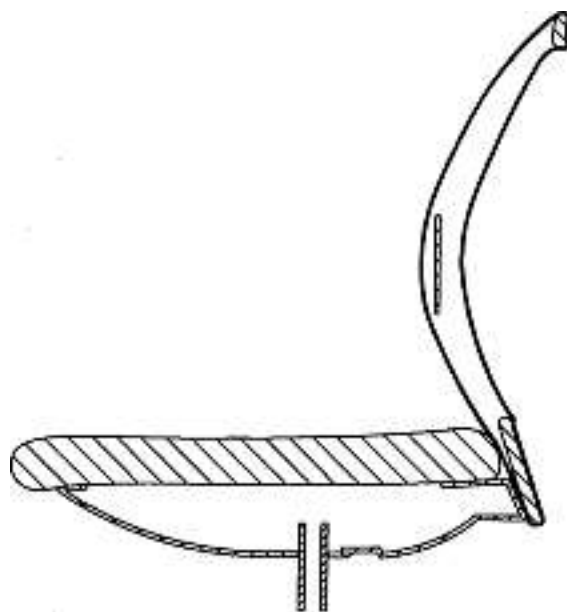

300388/2

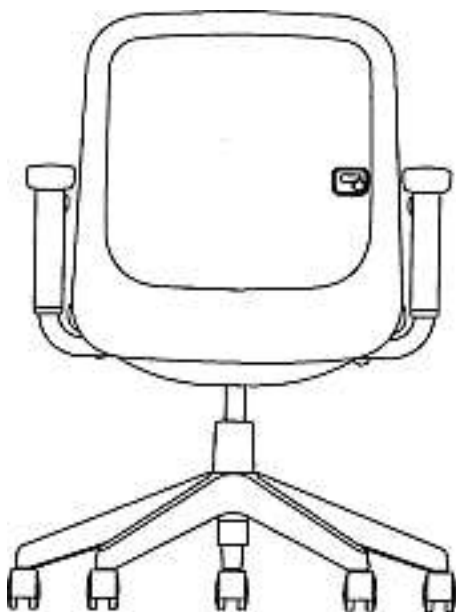
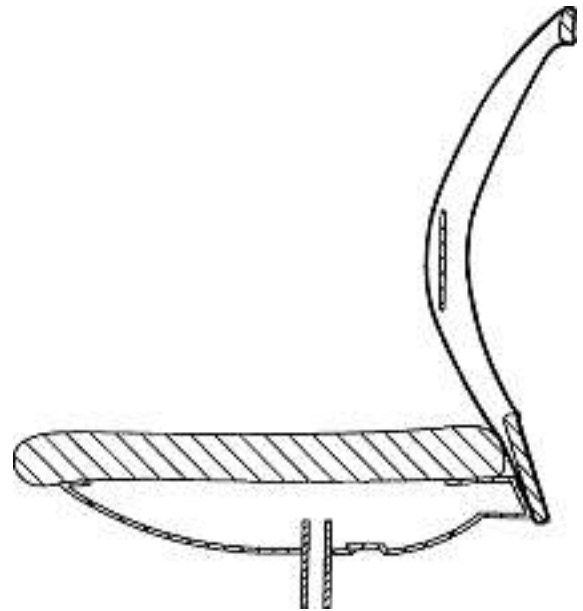
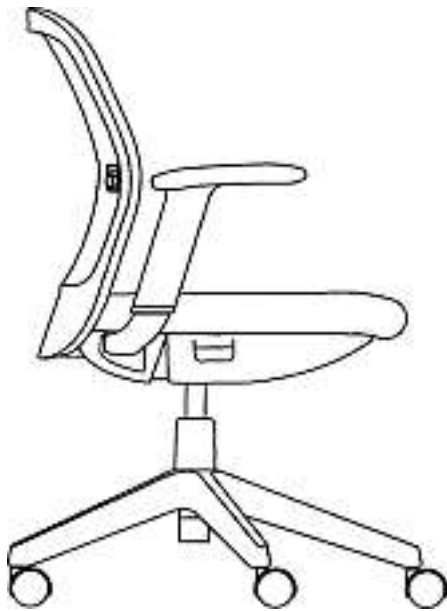
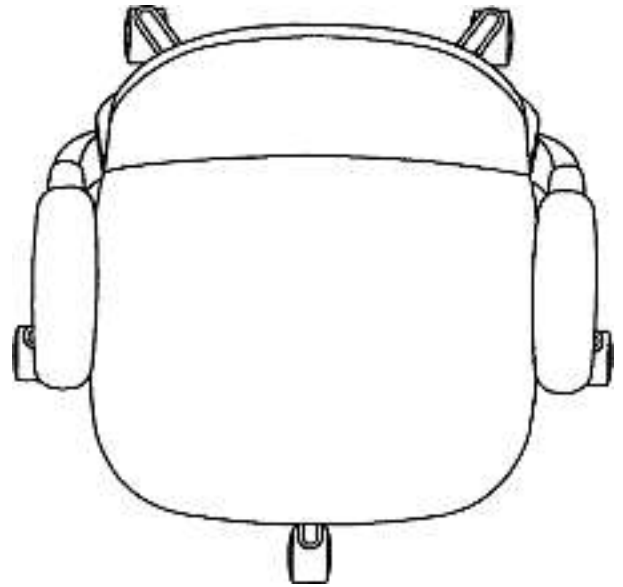
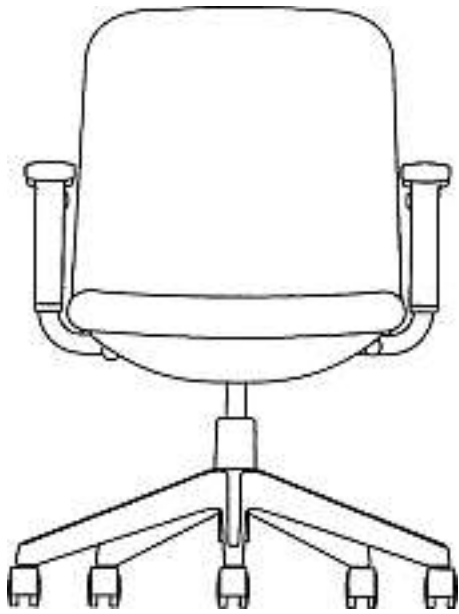



300388/3

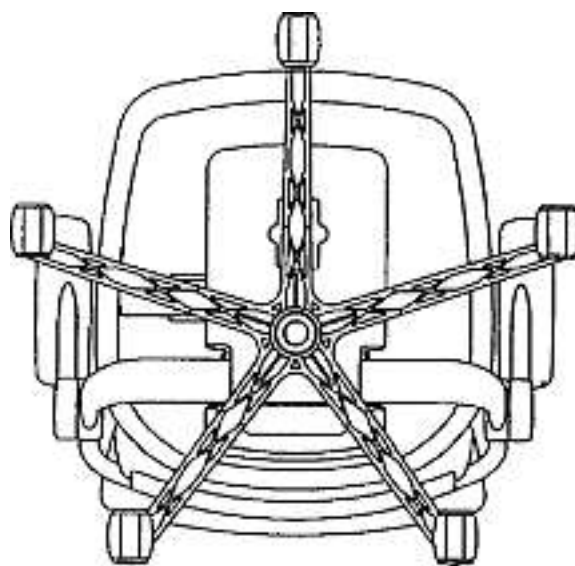
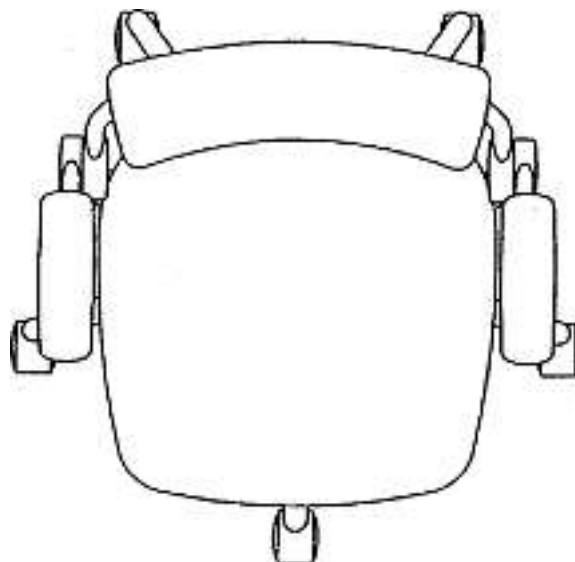
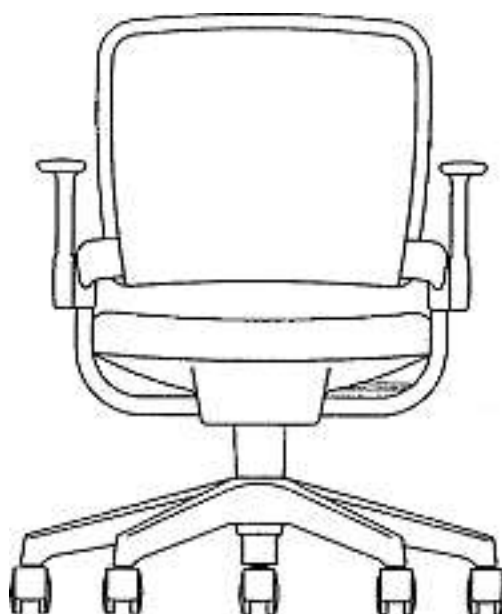



300388/4

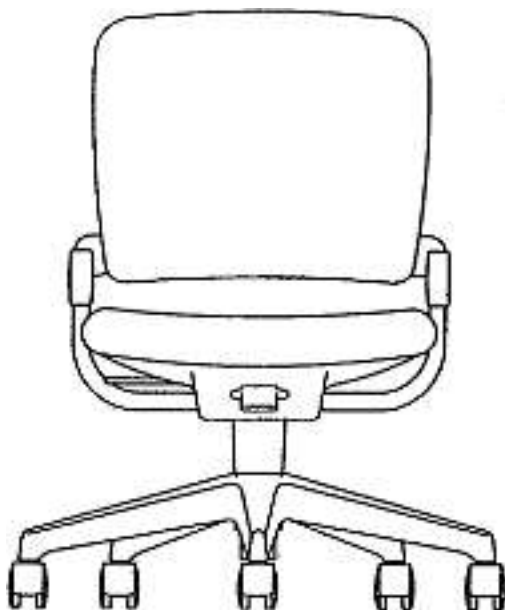

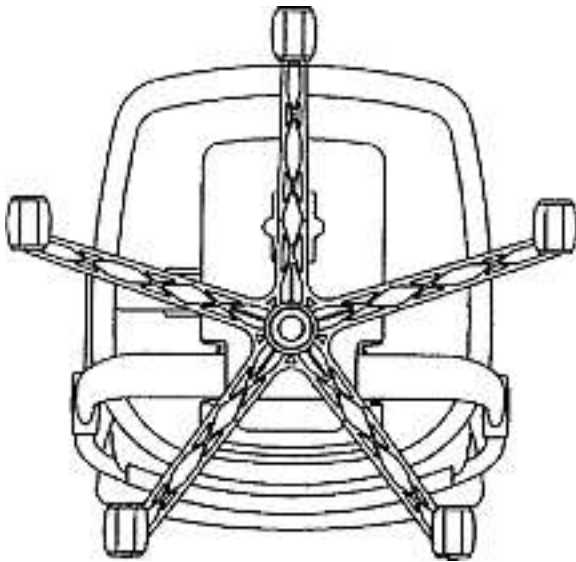

300388/5

Cl. 06-01, 06-03 **130 708** 12.05.2004
 2 Design – Tisch, Stuhl
 Hinterleger: Hansueli Hürlimann, Mattenhofstrasse 34,
 3007 Bern



19



20

Cl. 06-03 **130 710** 28.04.2004
 1 Design – Arbeitstisch
 Hinterleger: d.li Florin Baeriswyl, Schübelstrasse 17,
 8700 Küsnacht ZH
 Designer: Florin Baeriswyl, Küsnacht



LV 75

Cl. 06-04 **130 711** 28.04.2004
 1 Design – Regal
 Hinterleger: d.li Florin Baeriswyl, Schübelstrasse 17,
 8700 Küsnacht ZH
 Designer: Florin Baeriswyl, Küsnacht



LV 71

Cl. 06-04 **130 712** 28.04.2004
 1 Design – Bar Möbel
 Hinterleger: d.li Florin Baeriswyl, Schübelstrasse 17,
 8700 Küsnacht ZH
 Designer: Florin Baeriswyl, Küsnacht



LV 80

Cl. 07-01 **130 714** 30.04.2004
4 Design – Behälter für Nahrungsmittel
Hinterleger: Dil. S.r.l., S.S. Alba - Bra, 185,
12060 S. Vittoria d'Alba (Cuneo), IT
Designer: Massimo Di Lonardo, Moncalieri
Vertreter: Isler & Pedrazzini AG, 8023 Zürich
Priorität: IT, 03.11.2003

Cl. 06-06 **130 713** 27.04.2004
1 Design – Garderobe
Hinterleger: Mathias Bernhard, Schwarztorstrasse 124,
3007 Bern

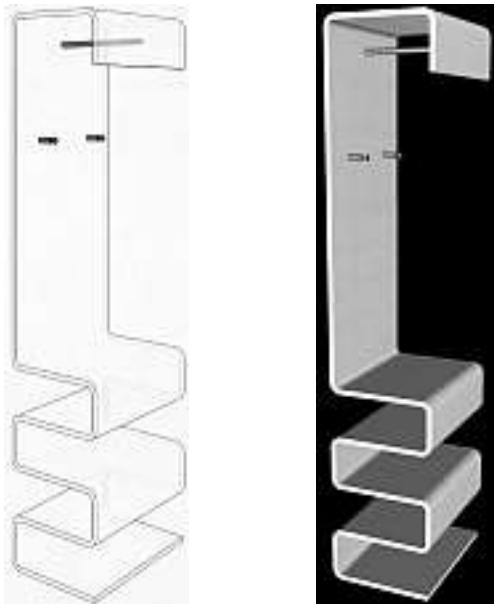



1



2

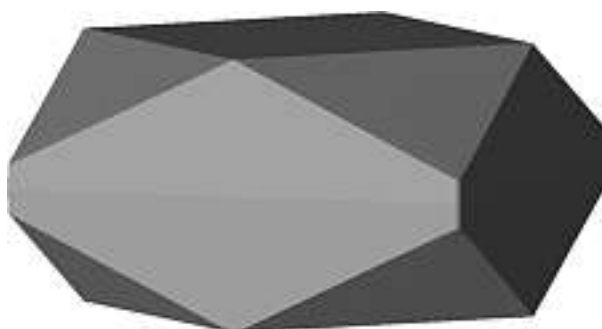
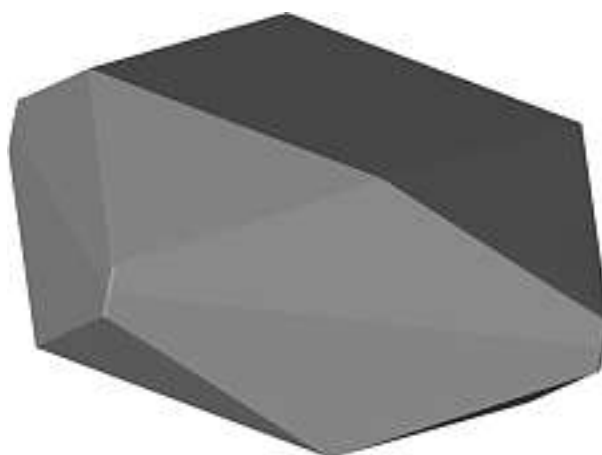

3

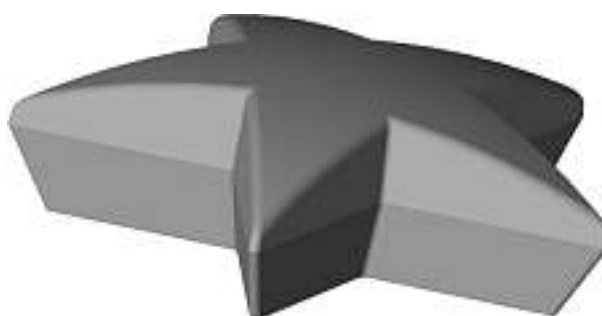



4

Cl. 07-01 **130 715** 13.05.2004
 2 Design – Schale für Lebensmittel
 Hinterleger: SEALPAC GmbH, An der Kolckwiese 10, Oldenburg, DE
 Designer: Stefan Dangel, Kutzenhausen
 Vertreter: Patentanwälte, Schaad, Balass, Menzl & Partner AG, 8034 Zürich
 Priorität: EM, 30.03.2004

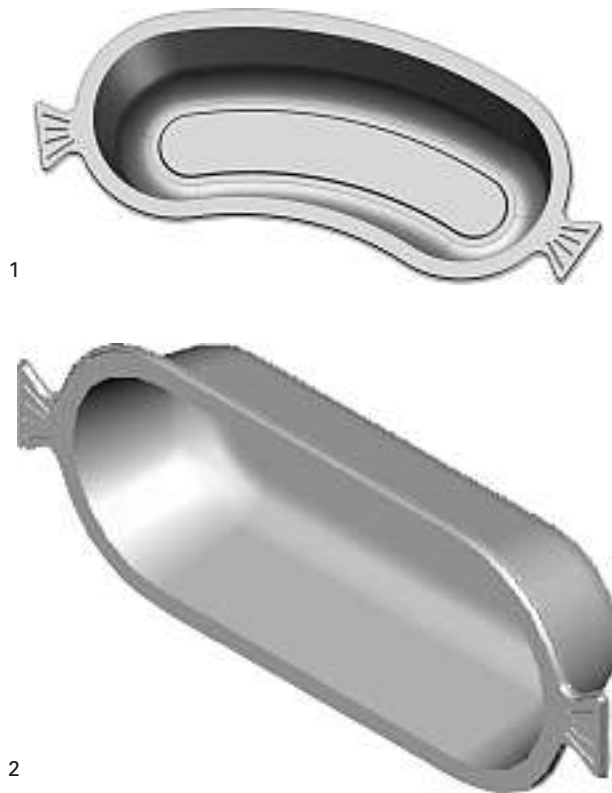

1

2



Cl. 08-06 **130 716** 26.04.2004
 1 Design – Tür- und Fenstergriff
 Hinterleger: Hoppe AG, Jaufenstrasse 16, St. Martin i.P., IT
 Designer: Alessandro Terzariol, Klausen; Mario Varesco, Bozen; Günther Kuhn, Meran
 Vertreter: PA Aldo Römpler, 9410 Heiden
 Priorität: EM, 05.11.2003



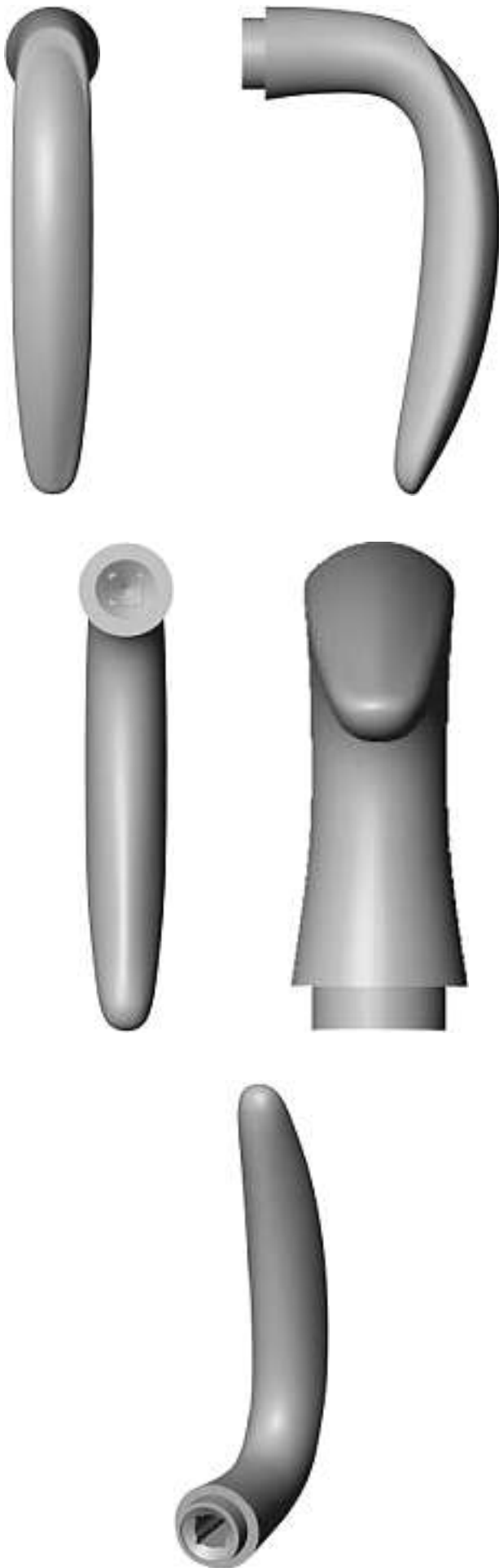

1

Cl. 09-01 130 717 30.04.2004
12 Design – Behälter
Hinterleger: Nussbaum Matzingen AG, Frauenfelderstrasse 67,
9548 Matzingen
Designer: Andreas Germann, Scherzingen
Vertreter: Frei Patentanwaltsbüro, 8029 Zürich



1a



1b



2a



2b



3a



3b



6a



6b



4a



4b



5a



5b



7a



7b

Cl. 09-01 130 718 14.05.2004
19 Design – Behälter
Hinterleger: Nussbaum Matzingen AG, Frauenfelderstrasse 67,
9548 Matzingen
Designer: Andreas Germann, Scherzingen
Vertreter: Frei Patentanwaltsbüro, 8029 Zürich



8a



8c



8b



9a



9b



10a



10b



11a



11b



12a



12b



13a



13b



14a



14b



15a



15b

Cl. 09-03 130 719 21.04.2004
4 Design – Verpackungsbemusterung
Hinterleger: Biophanie GmbH, Leymenstrasse 6,
4105 Biel-Benken BL
Designer: Marianne Martinelli, Biel-Benken

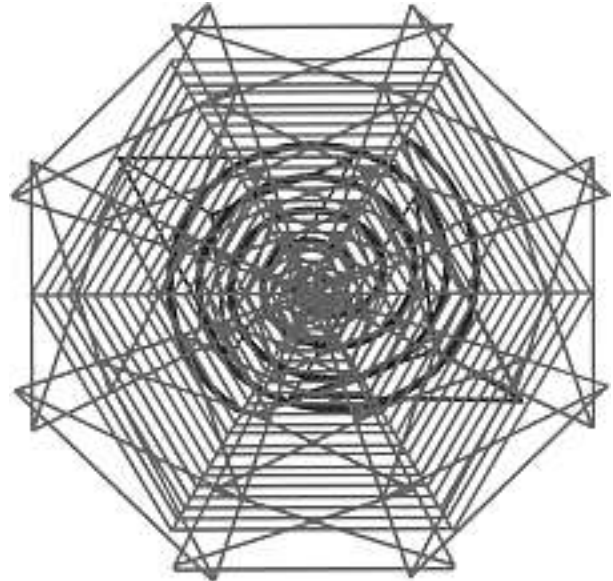

R6a

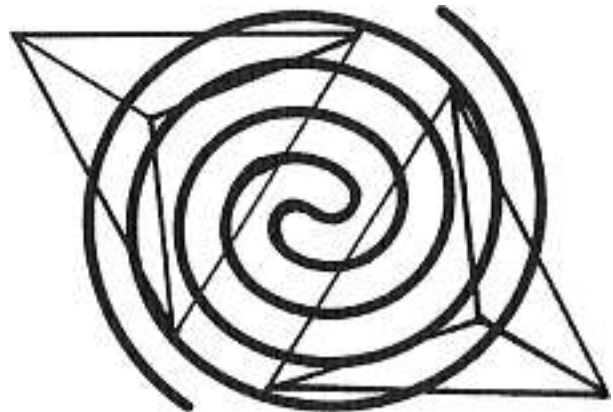

R6b

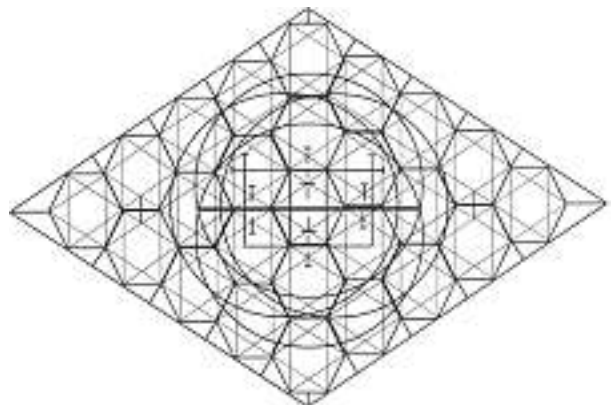

R6c

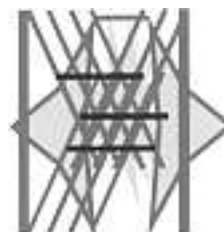

R6d

Cl. 10-02, 10-07 130 720 05.04.2004
24 design – montres, parties de montres
Déposant: Philippe Bonfanti, CCAS/SAAF, 10, rue Champront,
Besançon, FR
Mandataire: Etude Pierre Serge Heger, 1630 Bulle



P003B 01



P003B 02



P003B 05

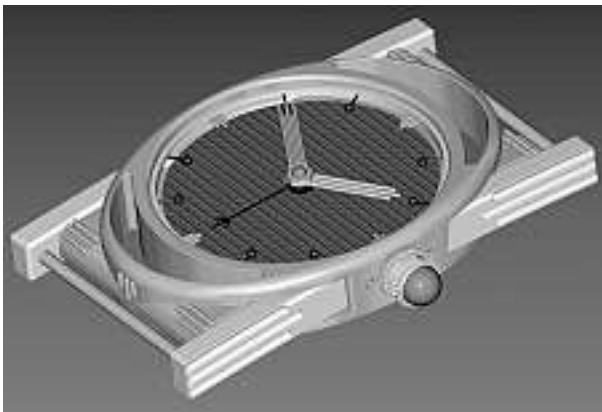

P003B 07



P003B 08

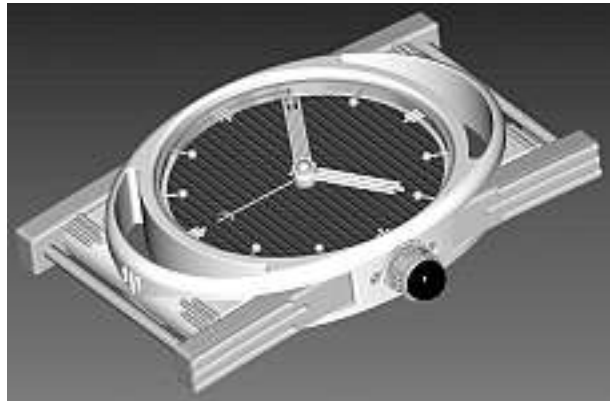

P003B 09



P004B 01





P005B 01



P011B 01



P011B 02



P006B 01



P006B 02



P011B 03



P012B 01



P007B 02



P008B 01



P013B 01



P013B 04



P015B 01



P019B 01



P020B 01



P021B 01

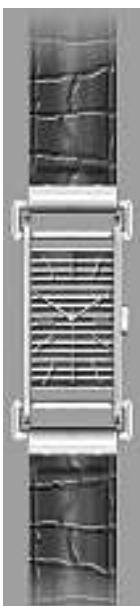

P021B 05



P022B 01

Cl. 10-02 130 721 22.04.2004
2 design – montres
Déposant: Idea Concept SA, Chemin des Barres 9,
2345 Les Breuleux
Designer: Nicolas Juillerat, Le Noirmont



01-2004



02-2004

Cl. 10-02 130 722 07.05.2004
 1 design – montre
 Déposant: MDM SA, Genève, 7, rue de la Fontaine,
 1204 Genève
 Designer: Carlo Crocco, Lugano
 Mandataire: INFOSUISSE Information Horlogère, et
 Industrielle, 2300 La Chaux-de-Fonds



Navratna 01

Cl. 10-02 130 723 11.05.2004
 9 design – montres-bracelets
 Déposant: Luxury Timepieces International SA,
 Ch. des Rochettes 2, 2016 Cortaillod
 Designer: Dino Modolo, La Chaux-de-Fonds
 Mandataire: Inteltech SA, 2001 Neuchâtel





158000/010191



158000/010291



158000/010391





158000/010491



158000/010591

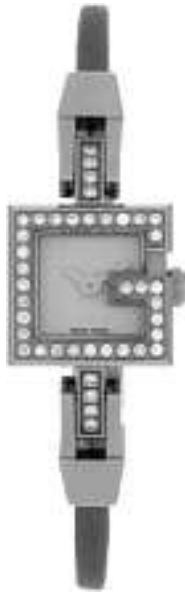

158000/010691





158000/010791



158000/010891



158000/010991

Cl. 10-04 **130 725** 14.05.2004

7 Design – Optoelektronische Sensoren, Anschlussmodul
 Hinterleger: SICK AG, Sebastian-Kneipp-Strasse 1,
 79183 Waldkirch, DE

Designer: Frank Detering, Stuttgart

Vertreter: patentanwälte breiter + wiedmer ag,
 8413 Neftenbach

Priorität: EM, 10.12.2003

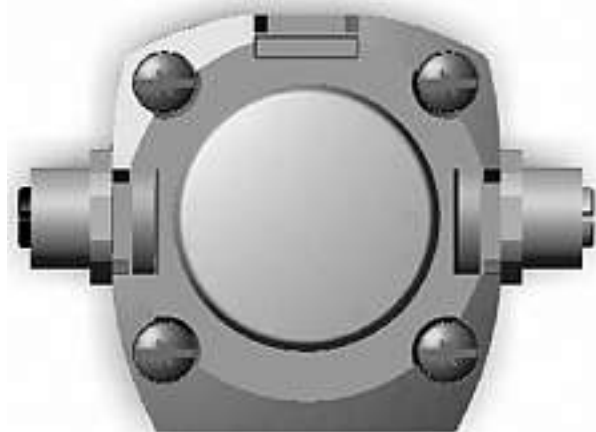

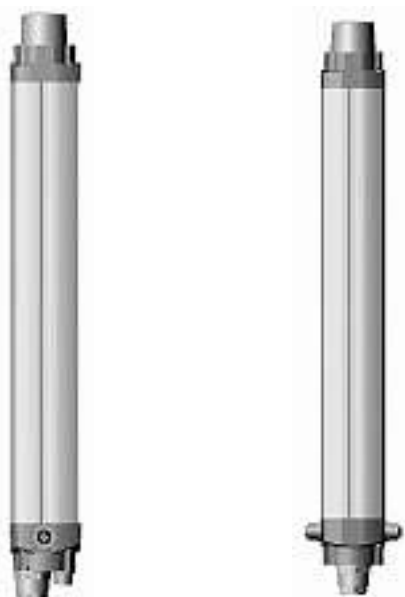
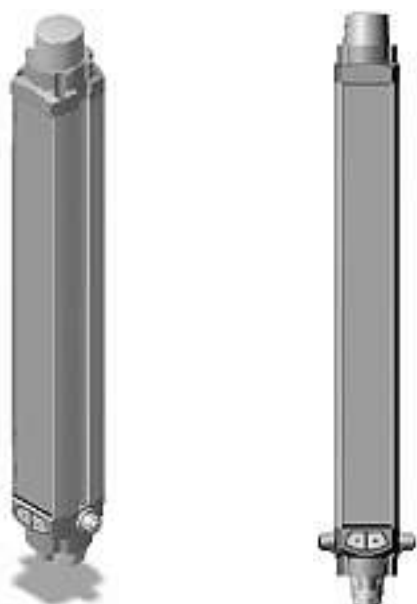

1



2





5



6



3

7



4

Cl. 10-07 **130 726** 08.05.2004
1 design – boucle pour bracelet
Déposant: Paul Junod LAB SA, 107, rue d'Aarberg,
2502 Bienne
Designer: Paul Junod, Bienne



001

Cl. 11-02 130 727 14.05.2004
 1 Design – Ziergegenstand
 Hinterleger: Josef A. Huber, Erachfeldstrasse 8, 8180 Bülach

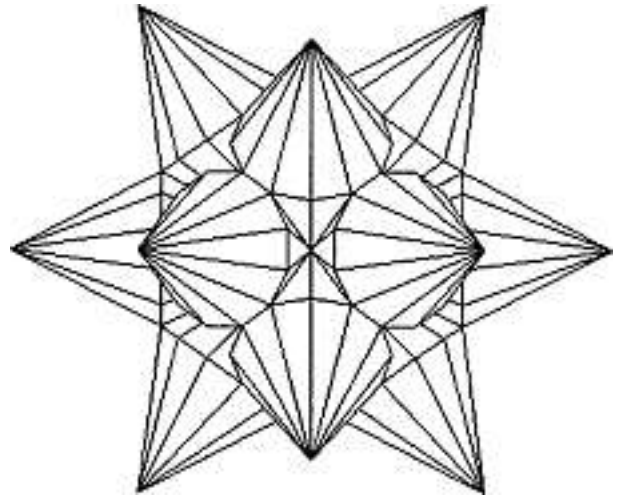

14star

Cl. 12-14 130 728 29.04.2004

1 Design – Schlitten
 Hinterleger: Thomas Allmendinger, Bruggwiesenstr. 7, 8152 Glattbrugg

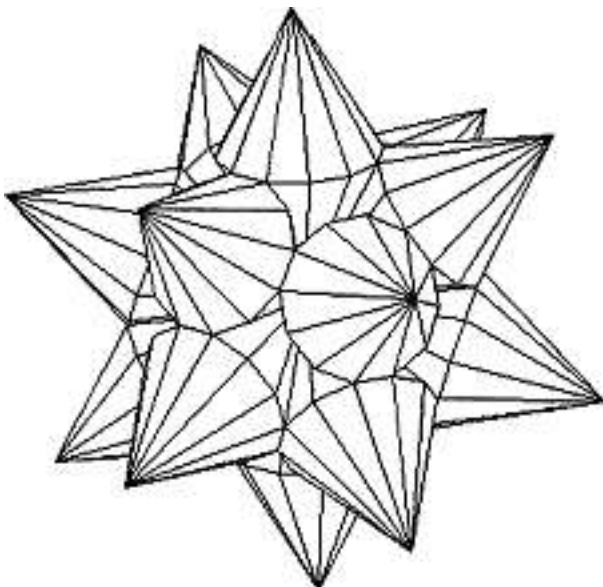
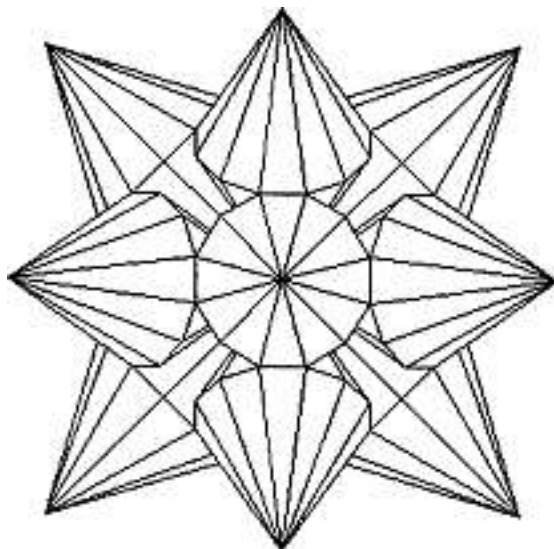



S-04

Cl. 13-03 130 729 04.05.2004
 2 Design – Kabelklammer
 Hinterleger: Easy Products S.L., Calle Casino n° 2,
 San Miguel de Abona / Tenerife, ES
 Designer: Joan Triola i Fort, San Miguel de Abona
 Vertreter: patentanwälte breiter + wiedmer ag,
 8413 Neftenbach
 Priorität: ES, 15.04.2004

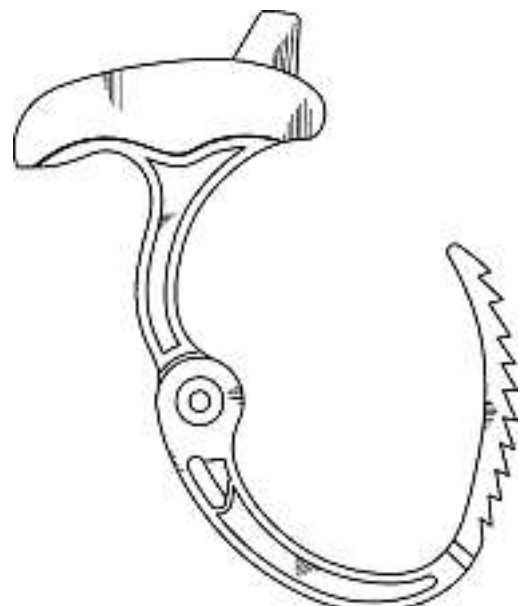
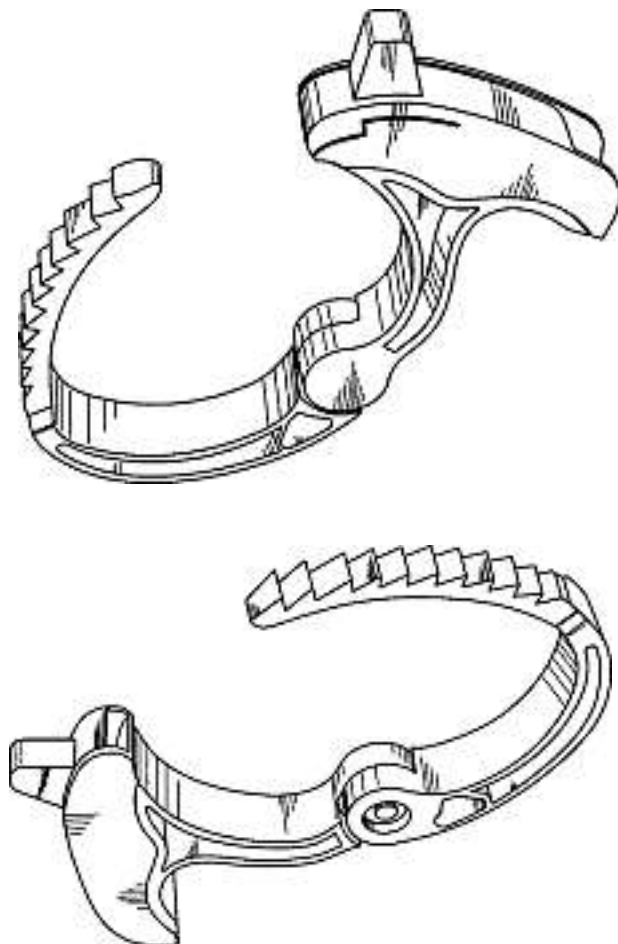
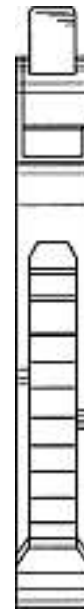
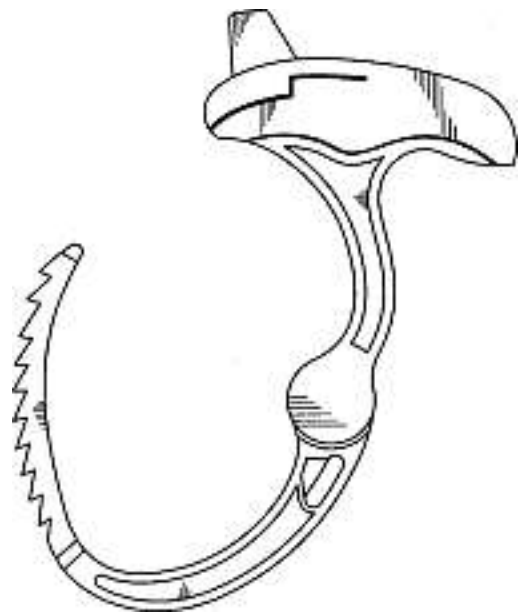

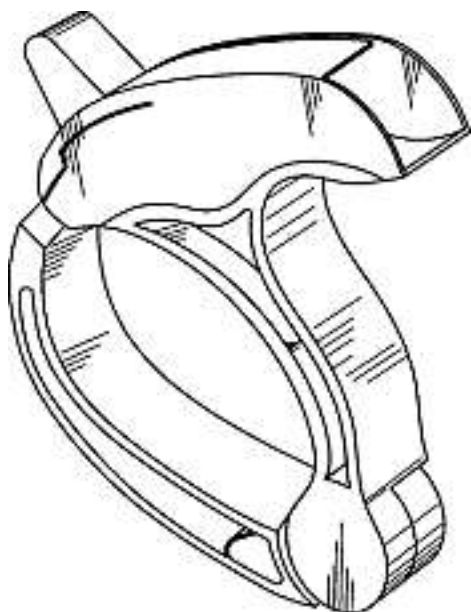
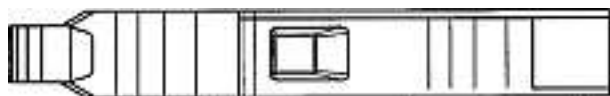
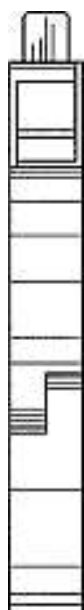

1

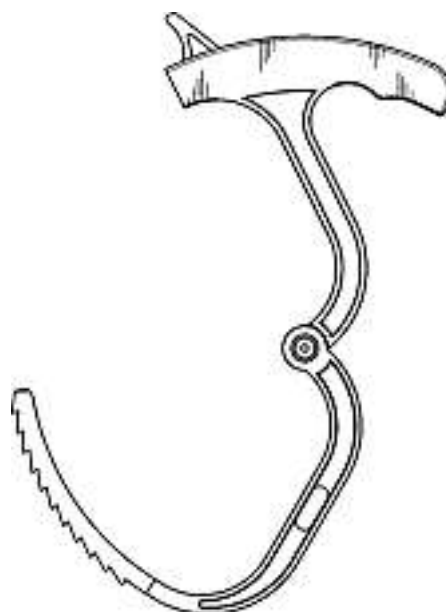
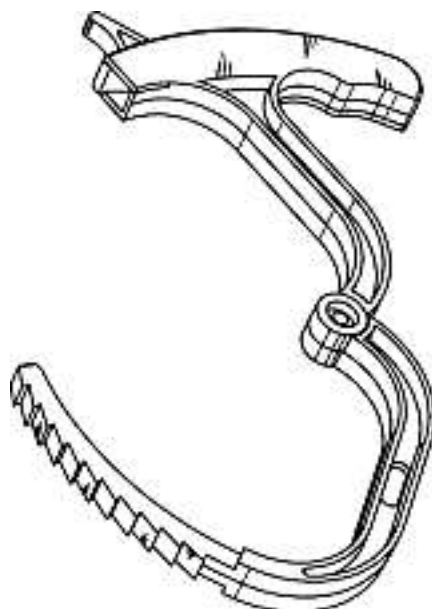
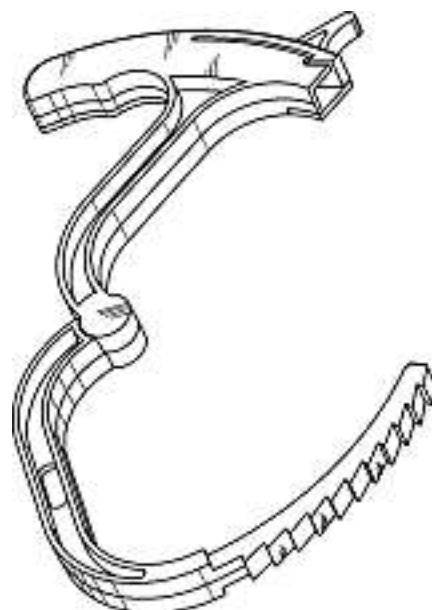
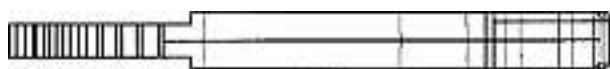

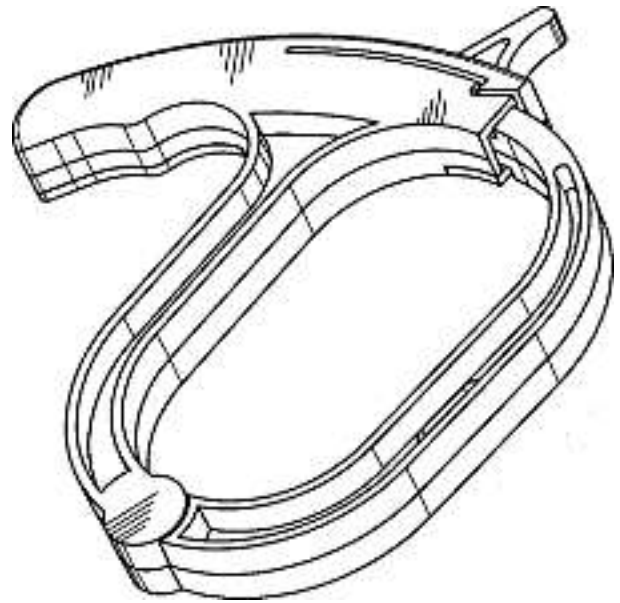
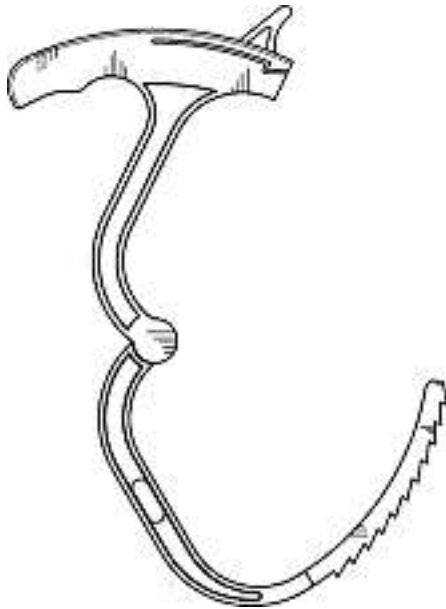

2

Cl. 13-03 130 730 04.05.2004
2 Design – Kabelkanal
Hinterleger: Easy Products S.L., Calle Casino n° 2,
San Miguel de Abona / Tenerife, ES
Designer: Joan Triola i Fort, San Miguel de Abona
Vertreter: patentanwälte breiter + wiedmer ag,
8413 Neftenbach
Priorität: ES, 15.04.2004

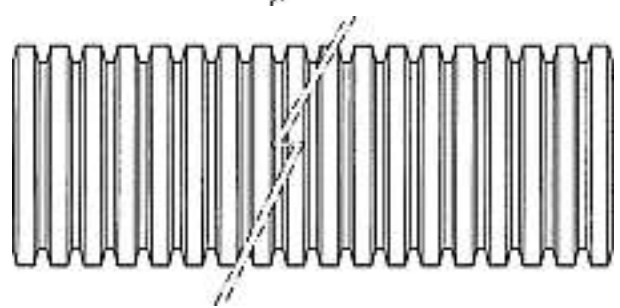
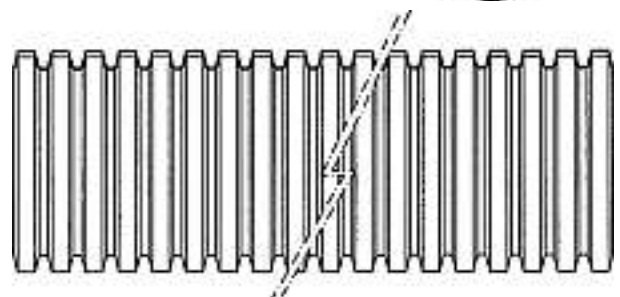
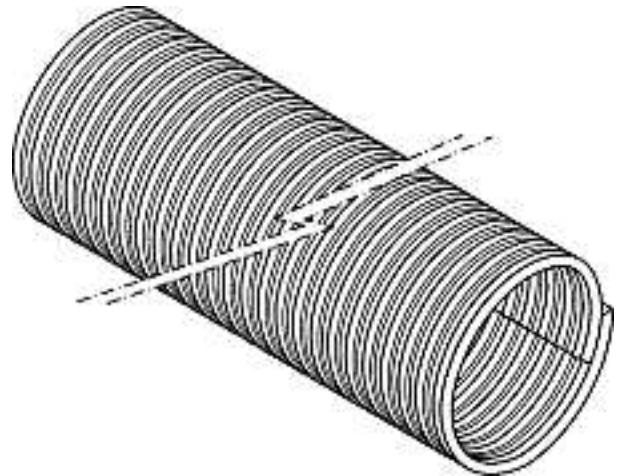

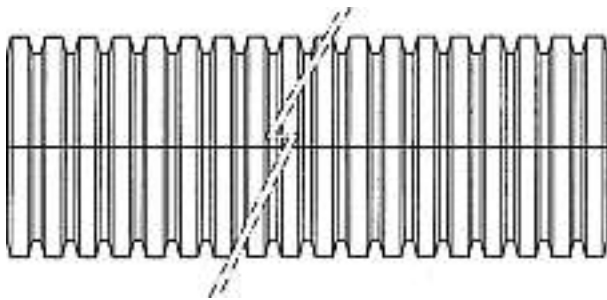
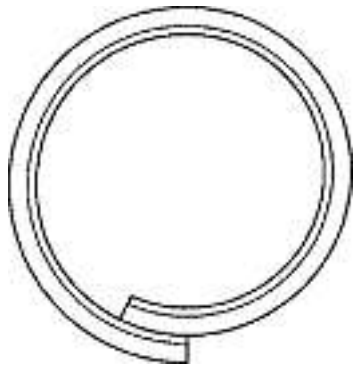
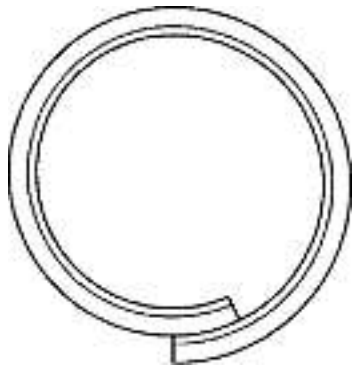

1

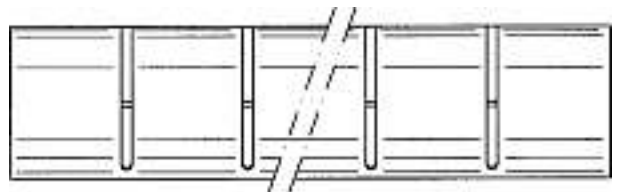
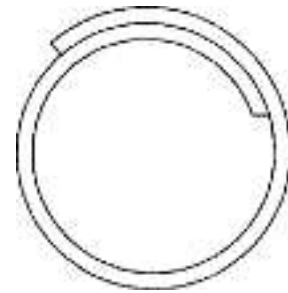
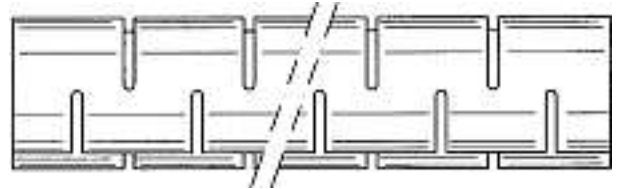
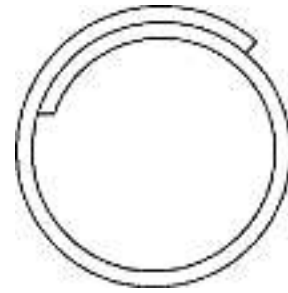
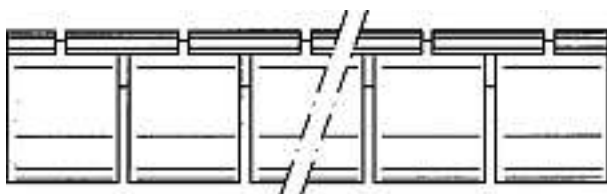
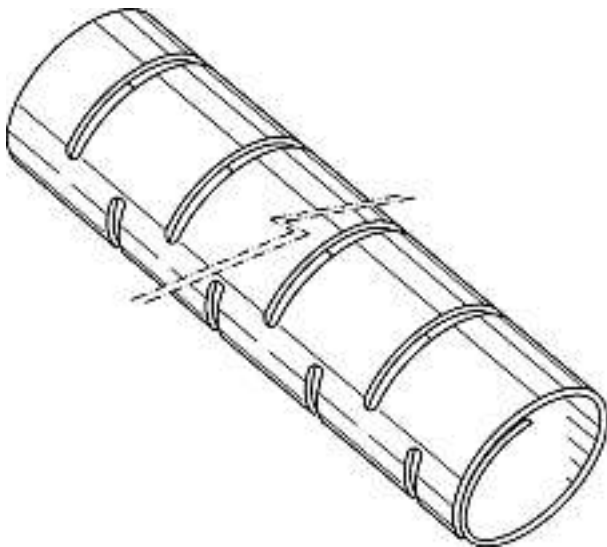

2

Cl. 13-03 130 731 04.05.2004

1 Design – Kabelführung
 Hinterleger: Easy Products S.L., Calle Casino n° 2,
 San Miguel de Abona / Tenerife, ES
 Designer: Joan Triola i Fort, San Miguel de Abona
 Vertreter: patentanwälte breiter + wiedmer ag,
 8413 Neftenbach
 Priorität: ES, 15.04.2004

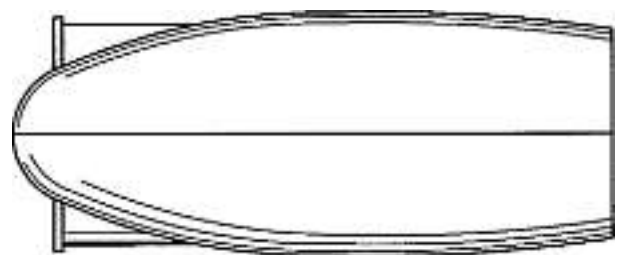

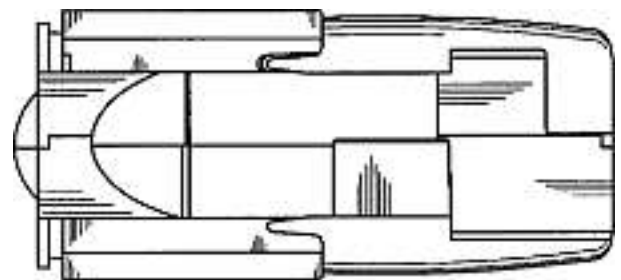
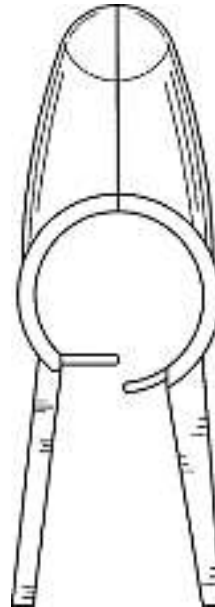
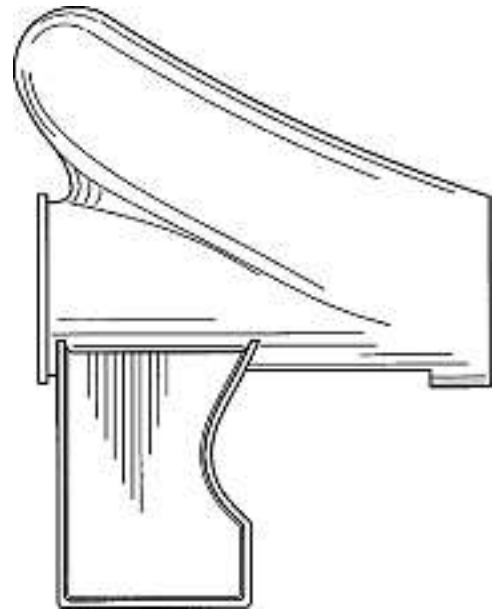
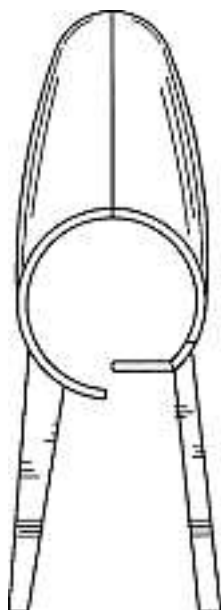
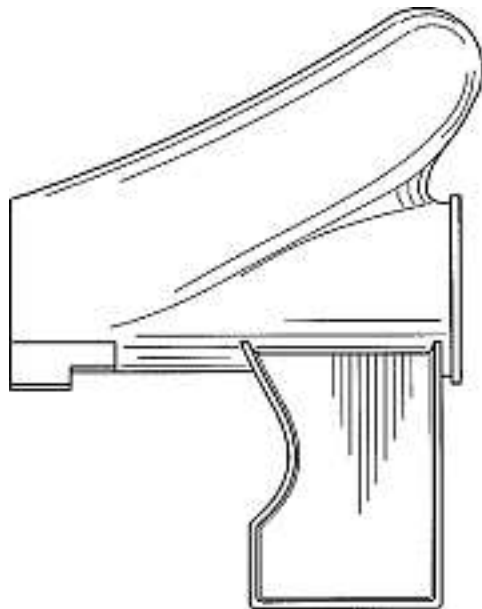
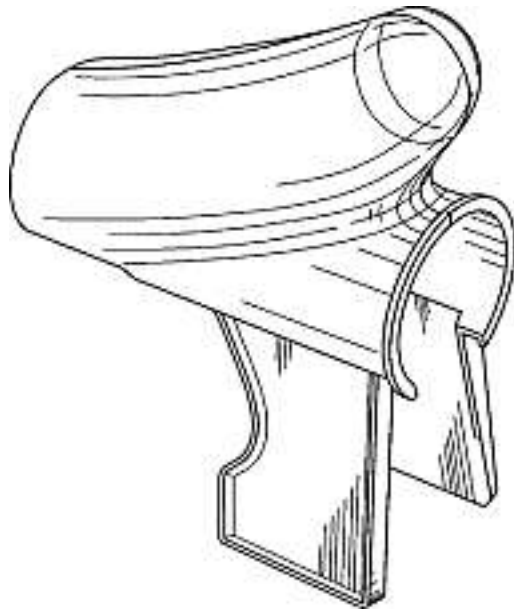

1

Cl. 15-02 **130 732** 29.04.2004
 1 Design – Pumpengehäuse
 Hinterleger: Vaillant GmbH, Berghauser Strasse 40,
 42859 Remscheid, DE
 Designer: Frank Salg, Remscheid
 Vertreter: Vaillant GmbH, 8953 Dietikon
 Priorität: DE, 08.12.2003



MR 277 CH

Cl. 15-09 **130 733** 16.05.2004
 1 Design – Einscheibenmaschine
 Hinterleger: Läpp-Technik A. W. Stähli AG, Sägestrasse 10,
 2542 Pieterlen
 Designer: Bernhard Stähli, Evilard

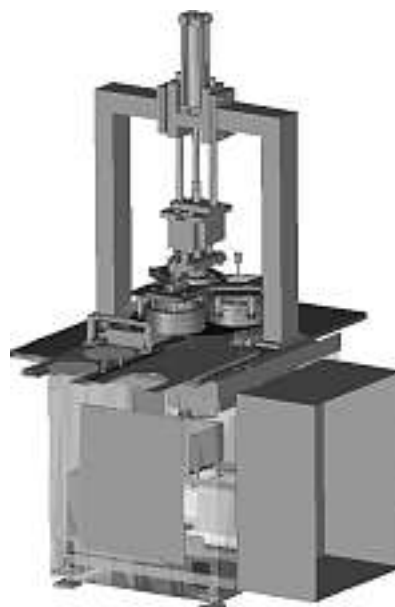
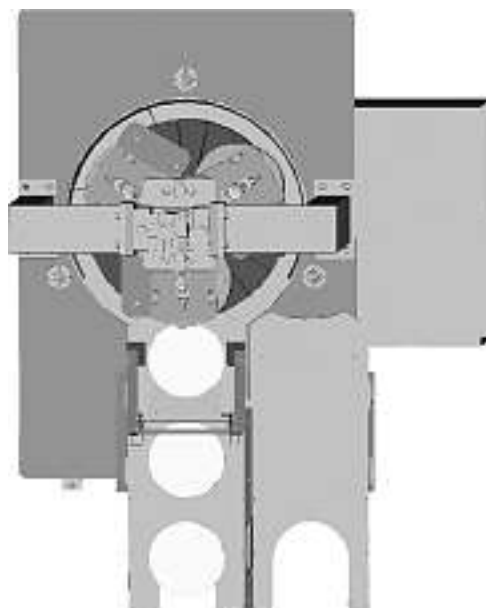

FLM505

Cl. 19-01 **130 734** 29.04.2004
 2 design – cartes
 Déposant: Jacques-Charles Roger Collet, case postale 2,
 1219 Aire, et Chantima Thiagno, case postale 2, 1219 Aire
 Mandataire: Jacques-Charles Roger Collet, 1219 Aire

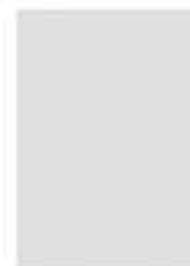

CC10

CP10

Cl. 19-08 130 735 27.04.2004
 1 Design – Werbemittel/Visitenkarte
 Hinterleger: Seedruck AG, Rietliaustrasse 2, Postfach 50,
 8804 Au ZH
 Designer: Jürg Eckert, Au ZH

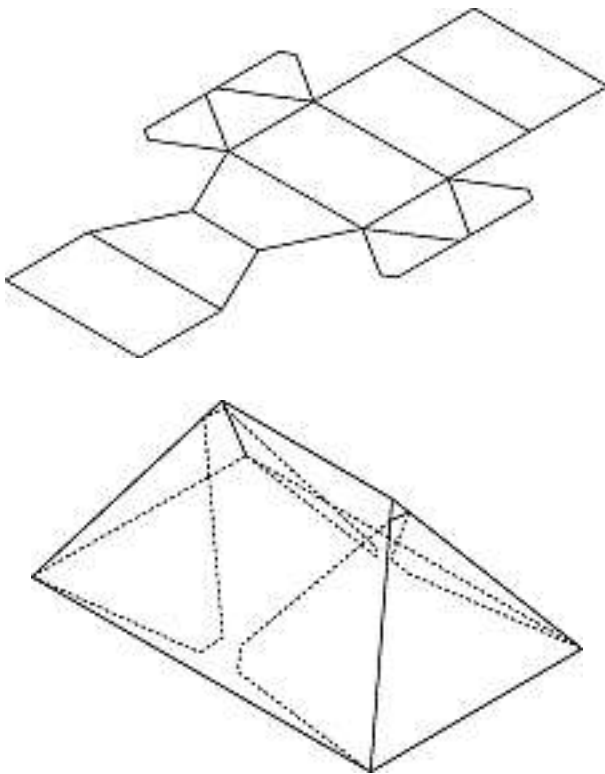

prisma card system

Cl. 19-08 130 736 06.05.2004
 1 Design – Notenblatt
 Hinterleger: Robert Klaus, Badenerstrasse 5a, 5442 Fislisbach



Royal Partitur

Cl. 20-02 130 737 30.04.2004
 1 Design – Verkaufstheke
 Hinterleger: A. Hiestand Holding AG, Industriestrasse 15,
 5242 Lupfig
 Designer: Michael Schai, Schlieren
 Vertreter: Wild Schnyder AG, 8032 Zürich



1

Cl. 20-02 130 738 05.05.2004
 8 Design – Präsentations- und Verkaufständer
 Hinterleger: Visplay International AG, Klünenfeldstrasse 22,
 4132 Muttenz
 Designer: Karsten K. Krebs, Hannover
 Vertreter: AXON Patent GmbH, 4147 Aesch



1



4



2



5



3



6

7



8

Cl. 20-03 **130 739** 05.05.2004
 1 Design – Stele
 Hinterleger: ISELI DESIGN & Partner AG,
 Weyermannsstrasse 28, 3008 Bern
 Designer: Lukas Wullimann, Bern; Martin Iseli, Bern

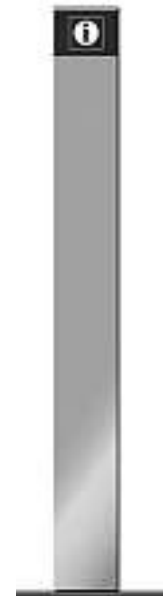
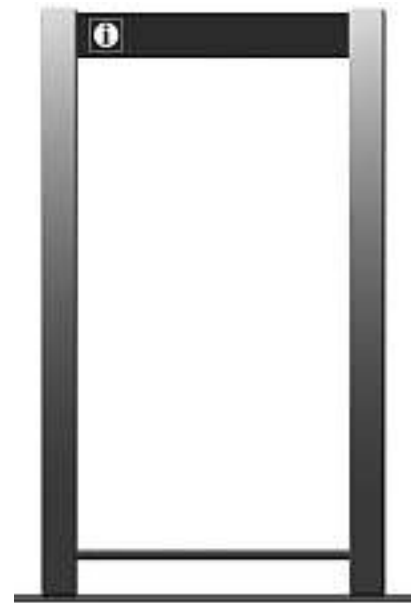

Stelenprinzip

Cl. 21-01 **130 740** 12.05.2004
 2 Design – Spiel und Teil davon
 Hinterleger: Rolf Rütter, Kirchstrasse 14, 3097 Liebefeld

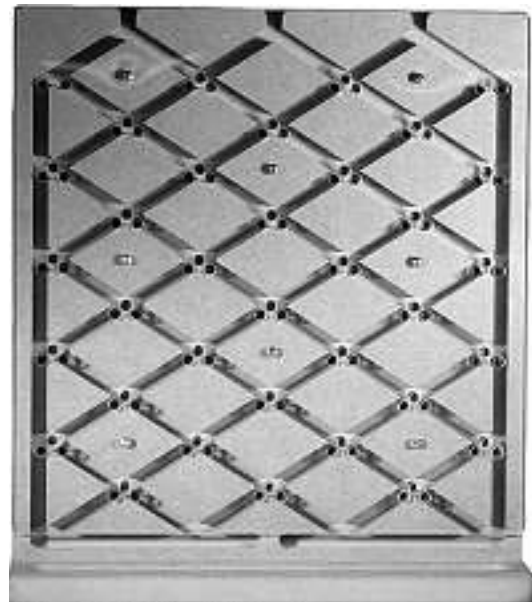



Stitchball 1

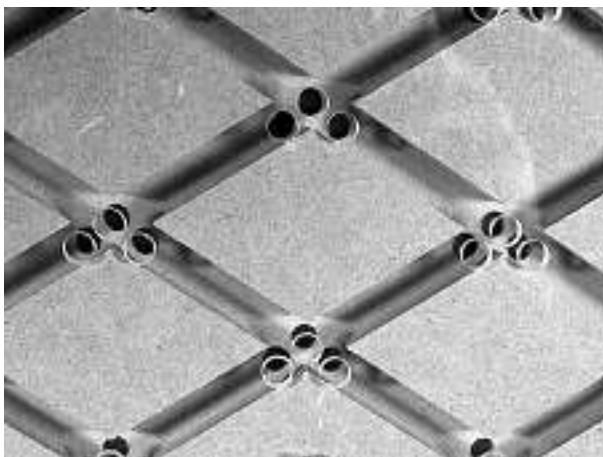

Stitchball 2

Cl. 23-02 **130 742** 23.04.2004
 1 design – colonne de douche
 Déposant: Drop S.r.l., Via Piemonte, 4,
 21040 Castronno (VA), IT
 Designer: Bruno Riva, Barasso
 Mandataire: SEDIN SA, 1207 Genève
 Priorité: EM, 12.11.2003



Cl. 23-01 **130 741** 27.04.2004
 1 Design – Sprinkler
 Hinterleger: Jomos Brandschutz GmbH, Gewerbestrasse 4,
 4450 Sissach
 Designer: Peter Kammer, Derendingen



ELO Spray-Sprinkler K160





2



3



4



5

CH/DP/022004

Cl. 23-02 **130 743** 11.05.2004
 10 Design – Lavabos, WCs, Bidets
 Hinterleger: Keramik Holding AG Laufen, Wahlenstrasse 46,
 4242 Laufen
 Designer: Peter Wirz, Luzern
 Vertreter: A. Braun, Braun, Héritier, Eschmann AG,
 Patentanwälte, 4051 Basel



1



6



7



8



9



10

Cl. 23-04 130 744 13.05.2004
 1 Design – Duftvignette
 Hinterleger: d.li Florin Baeriswyl, Schübelstrasse 17,
 8700 Küsnacht ZH
 Designer: Florin Baeriswyl, Küsnacht
 Vertreter: Keller & Partner, Patentanwälte AG, 3000 Bern 7

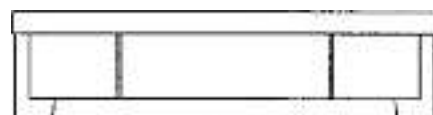
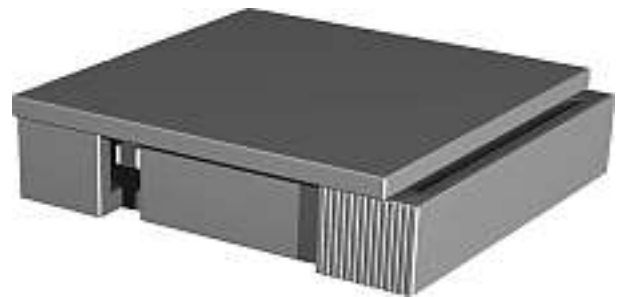

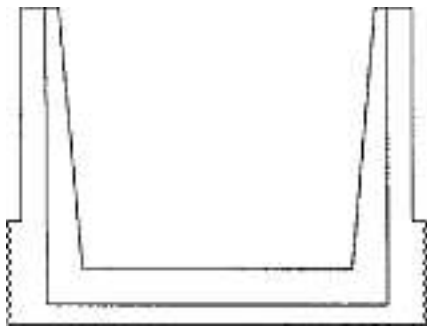
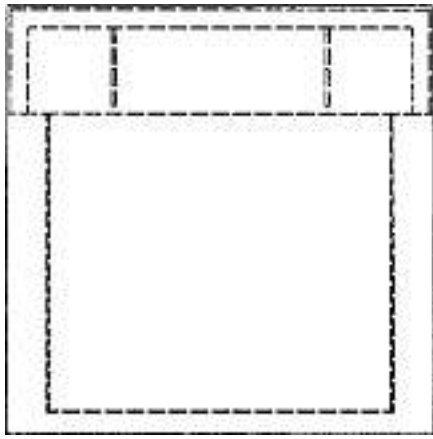

1

Cl. 25-01 **130 746** 06.05.2004
 3 Design – Bauprofile
 Hinterleger: Matrix Systems GmbH, Dorfstrasse 57,
 8103 Unterengstringen
 Designer: Edwin Huber, Andelfingen



Basicprofil 2



Umantis 2



Umantis 3

Cl. 25-02 **130 747** 23.04.2004
 1 Design – Türe
 Hinterleger: Giovanni Melillo, Wiesäcker 28, Hohentengen, DE
 Vertreter: Arie Wubben, 8942 Oberrieden
 Priorität: EM, 04.11.2003



1

Cl. 25-02 **130 748** 06.05.2004
 1 Design – Sichtschutzelement
 Hinterleger: Albin Heeb, Stockenstrasse 15, 9464 Lienz



Säule P 240

Cl. 25-03 130 749 05.05.2004
 1 Design – Haus
 Hinterleger: Mario Anderegg, Hauptstrasse 13, 8505 Pfy
 Designer: Peter Bunkus, Eschenz

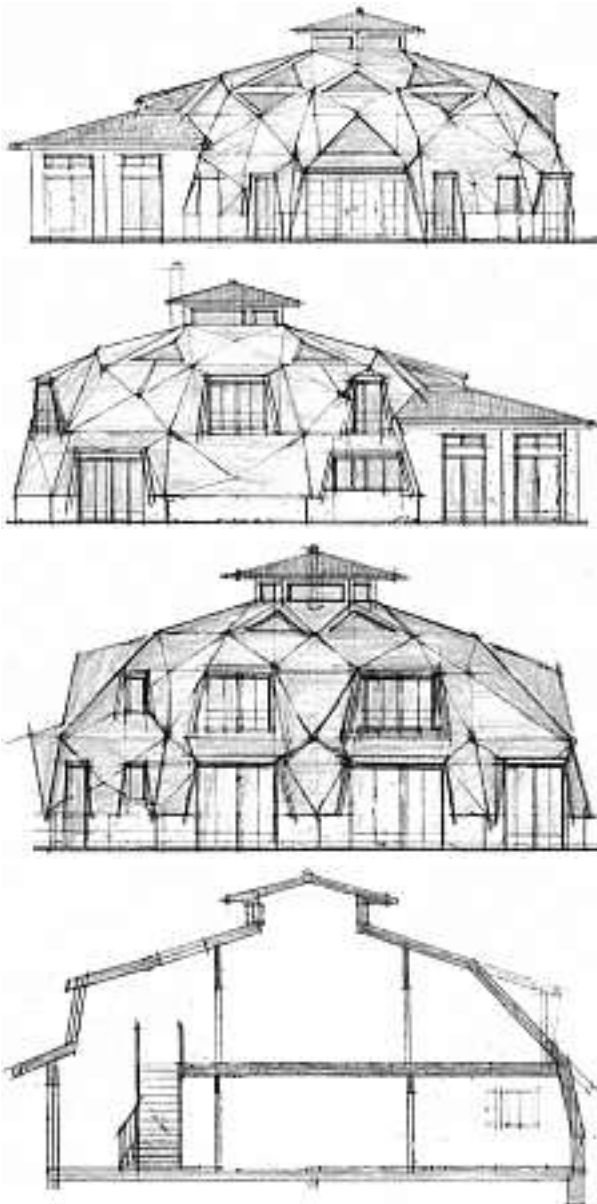

Feng Shui-Domehaus

Cl. 26-05 130 750 04.05.2004
 4 design – lampe
 Déposant: Orbis Design S.à.r.l., Rte de Cossonay 100,
 1008 Prilly
 Designer: Felix Rehsteiner, Pully



2004-1



2004-2



2004-3



2004-4

Cl. 26-05 130 751 07.05.2004
 1 Design – Lampe
 Hinterleger: Louis Poulsen Lighting A/S, Nyhavn 11,
 Kopenhagen, DK
 Designer: Louise Campell, Kopenhagen
 Vertreter: Isler & Pedrazzini AG, 8023 Zürich
 Priorität: DK, 16.04.2004

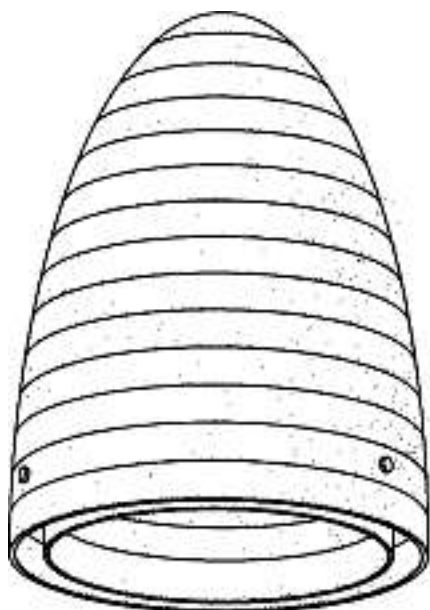
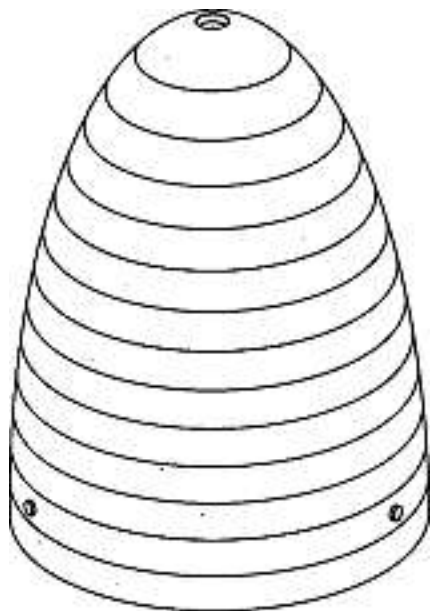
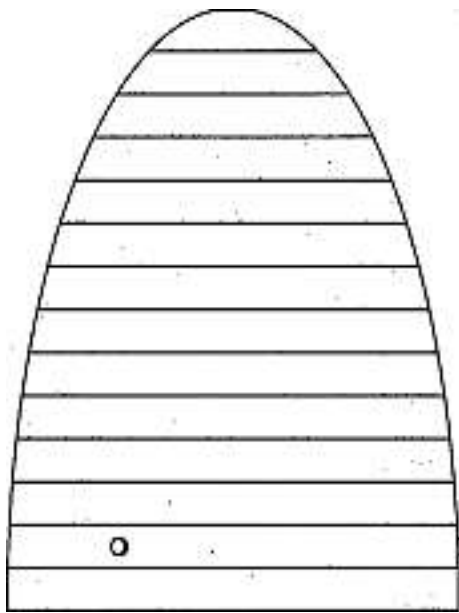

Cl. 26-05 130 752 11.05.2004
 1 Design – Leuchte
 Hinterleger: LRG Licht + Raum AG, Hinterer Schermen 44,
 3063 Ittigen
 Designer: Christian Deuber, Luzern



LLP.35

Cl. 27-99 130 753 08.05.2004
 1 Design – Zigarrenabschneider
 Hinterleger: Davidoff & Cie SA, 2, rue de Rive, 1200 Genève
 Designer: René Hollenstein, Oberwil
 Vertreter: Meisser & Partner, 7250 Klosters





452

Verlängerungen Prolongations Prolongazioni

117 702 Cl. 24-02 1 Design

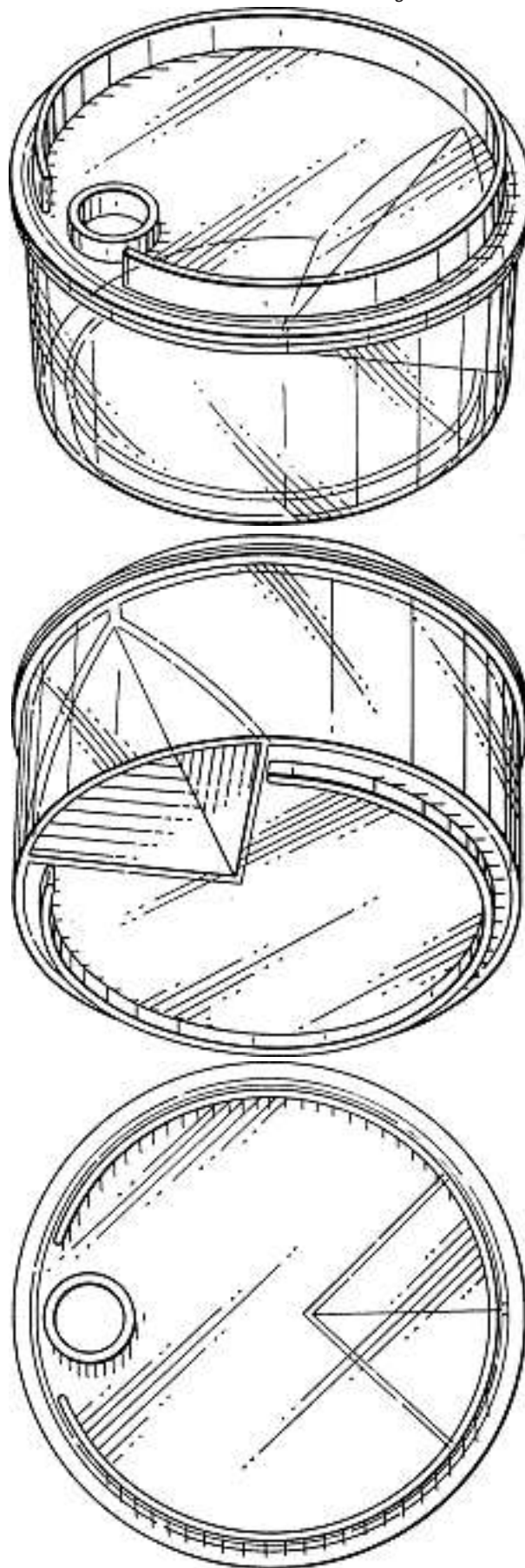

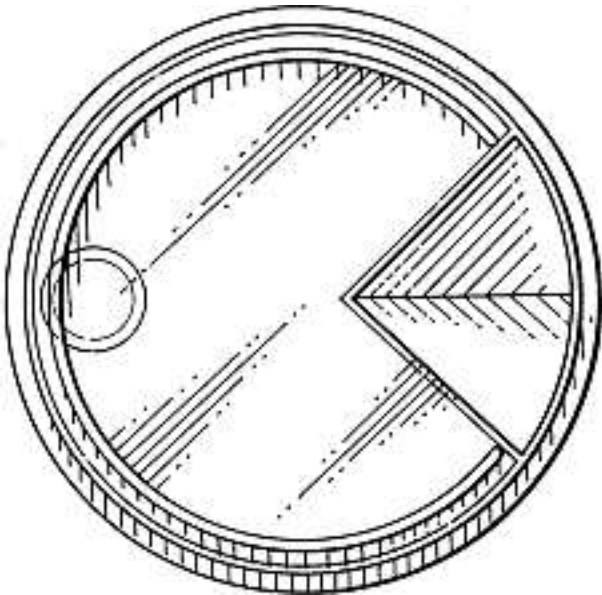

D.69/89

121 447	Cl.	06-01	1 Design
121 448	Cl.	06-01	1 Design
121 457	Cl.	07-01	1 Design
121 459	Cl.	07-04	1 Design
121 470	Cl.	09-03	1 Design
121 512	Cl.	12-15	1 design
121 533	Cl.	08-05	2 Design
121 544	Cl.	19-04	1 design
121 557	Cl.	07-01	2 Design
121 605	Cl.	08-05	1 design
121 612	Cl.	09-07	1 Design
121 627	Cl.	24-02	1 Design
121 670	Cl.	25-01	1 design
121 701	Cl.	24-04	1 Design
121 740	Cl.	24-04	2 Design
121 743	Cl.	25-02	2 Design
121 752	Cl.	02-03	3 Design
121 835	Cl.	01-04	1 Design
125 820	Cl.	20-02	1 Design
126 058	Cl.	03-01	1 Design
126 067	Cl.	09-03	1 Design
126 077	Cl.	19-04	1 Design
126 125	Cl.	20-02	1 Design
126 151	Cl.	07-07	3 Design
126 152	Cl.	07-07	1 Design
126 212	Cl.	25-01	1 design
126 235	Cl.	10-02	4 design
126 236	Cl.	10-05	3 design
126 260	Cl.	04-02	1 Design
126 272	Cl.	08-05	3 Design
126 290	Cl.	20-02	1 Design
126 341	Cl.	07-01	3 Design
126 430	Cl.	19-04	1 Design

117 744 Cl. 07-02 1 Design



114085

**Löschungen
Radiations
Radiazioni**

117 089	Cl.	13-03	1 Design
117 116	Cl.	10-07	1 design
121 003	Cl.	02-07	6 Design
121 006	Cl.	04-02	6 Design
121 014	Cl.	07-01	2 Design
121 016	Cl.	09-99	1 Design
121 070	Cl.	14-03	3 Design
121 074	Cl.	15-99	1 Design
121 115	Cl.	14-03	1 design
125 599	Cl.	19-08	60 Design
125 617	Cl.	15-05	3 Design
125 627	Cl.	06-01	4 Design
125 628	Cl.	06-04	64 Design
125 630	Cl.	06-03	1 Design
125 633	Cl.	06-04	2 Design
125 639	Cl.	07-03	9 design
125 643	Cl.	08-09	9 Design
125 644	Cl.	09-01	1 Design
125 645	Cl.	09-03	1 design
125 646	Cl.	09-03	1 design
125 647	Cl.	10-01	1 Design
125 648	Cl.	10-02	1 design
125 649	Cl.	10-02	1 Design
125 650	Cl.	10-03	1 Design
125 651	Cl.	11-02	1 Design
125 654	Cl.	23-02	3 Design
125 663	Cl.	03-01	1 Design
125 669	Cl.	07-99	6 Design
125 752	Cl.	06-09	1 design
125 795	Cl.	03-01	2 Design
125 817	Cl.	20-02	4 design