

Nationale Hinterlegungen

In der folgenden Liste werden die beim Eidgenössischen Institut für Geistiges Eigentum hinterlegten Designs publiziert. Dabei sind der Reihe nach angegeben:

- internationale Klassenangaben
- Hinterlegungsnummer
- Hinterlegungsdatum
- Allenfalls Aufschub der Veröffentlichung
- Anzahl der hinterlegten Designs
- Bezeichnung
- Name und Wohnsitz des Hinterlegers oder der Hinterlegerin
- gegebenenfalls Name und Wohnsitz des Designers oder der Designerin
- Name und Geschäftssitz des allfälligen Vertreters oder der Vertreterin
- gegebenenfalls Prioritätsangaben
- gegebenenfalls Beschreibungstext
- Ordnungsnummer
- Reproduktion des Designs

Internationale Hinterlegungen

Die bei der Weltorganisation für geistiges Eigentum in Genf hinterlegten Muster und Modelle mit Benennung Schweiz geniessen den gleichen Schutz wie national hinterlegte Designs. Sie werden jeweils im Blatt «Bulletin des dessins et modèles internationaux» veröffentlicht. Dieses Publikationsorgan ist deshalb für eine vollständige Recherche unbedingt beizuziehen.

Topographien

Angaben über die vom Eidgenössischen Institut für Geistiges Eigentum eingetragenen Topographien von Halbleitererzeugnissen werden in folgender Anordnung aufgeführt:

- Eintragsnummer
- Anmeldedatum
- Bezeichnung
- Name und Wohnsitz des Anmelders oder der Anmelderin
- gegebenenfalls Name und Wohnsitz des Herstellers oder der Herstellerin
- Name und Geschäftssitz des oder der allfälligen Bevollmächtigten
- Datum und Ort einer allfälligen ersten geschäftlichen Verbreitung der Topographie

Dépôts nationaux

Les designs déposés à l'Institut Fédéral de la Propriété Intellectuelle sont publiés dans la liste qui suit. Les indications y relatives sont mentionnées dans cet ordre:

- indications des classes internationales
- numéro de dépôt
- date de dépôt
- le cas échéant, ajournement de la publication
- nombre des designs déposés
- désignation
- nom et domicile du/de la déposant/e
- le cas échéant, nom et domicile du/de la designer
- nom et domicile de l'éventuel/le mandataire
- le cas échéant, indication de priorité
- le cas échéant, description du design
- numéro attribué à chaque design
- reproduction du design

Dépôts internationaux

Les dessins et modèles déposés à l'Organisation Mondiale de la Propriété Intellectuelle à Genève qui désignent la Suisse jouissent de la même protection que les dépôts nationaux. Ils sont chaque fois publiés dans la feuille «Bulletin des dessins et modèles internationaux». Pour une recherche complète, il est indispensable de consulter ledit organe de publication.

Topographies

Les indications concernant les topographies des produits semi-conducteurs, enregistrées par l'Institut Fédéral de la Propriété Intellectuelle, sont énumérées dans l'ordre suivant:

- numéro d'enregistrement
- date de dépôt
- désignation
- nom et domicile du/de la déposant/e
- le cas échéant, nom et domicile du/de la producteur/trice
- nom et domicile de l'éventuel/le mandataire
- date et lieu d'une éventuelle première mise en circulation de la topographie

Depositi nazionali

Nella lista seguente vengono pubblicati i design depositati presso l'Istituto Federale della Proprietà Intellettuale. Sono menzionati nel seguente ordine:

- indicazioni delle classi internazionali
- numero di deposito
- data del deposito
- se del caso, indicazione che la pubblicazione è stata differita
- numero dei design depositati
- designazione
- nome e domicilio del depositante
- se del caso, nome e domicilio del designer
- nome e sede di un eventuale mandataro
- se del caso, indicazioni di priorità
- se del caso, descrizione del design
- numero d'ordine
- riproduzione del design

Depositi internazionali

I disegni e modelli depositati presso l'Organizzazione Mondiale della Proprietà Intellettuale a Ginevra con denominazione Svizzera godono della medesima protezione del deposito nazionale. Essi vengono pubblicati ogni volta nel foglio «Bulletin des dessins et modèles internationaux». Quest'organo di pubblicazione è da consultare se si vuole effettuare una ricerca completa.

Topografie

Le indicazioni concernenti le topografie di prodotti a semiconduttori depositati presso l'Istituto Federale della Proprietà Intellettuale sono menzionate nell'ordine seguente:

- numero di registrazione
- data del deposito
- designazione
- nome e domicilio del/la richiedente
- se del caso, nome e domicilio del/la produttore/trice
- nome e sede di un eventuale mandataro
- data e luogo di un'eventuale prima messa in circolazione della topografia

Hinterlegungen
Dépôts
Depositi

Cl. 06-11 132 233 24.10.2005
1 Design – Teppich-Leuchte
Hinterleger: Noëlle Beck-von Wyl, Gotthardstrasse 31,
6300 Zug
Vertreter: Celea GmbH, 6300 Zug
Ende aufgeschobene Publikation:

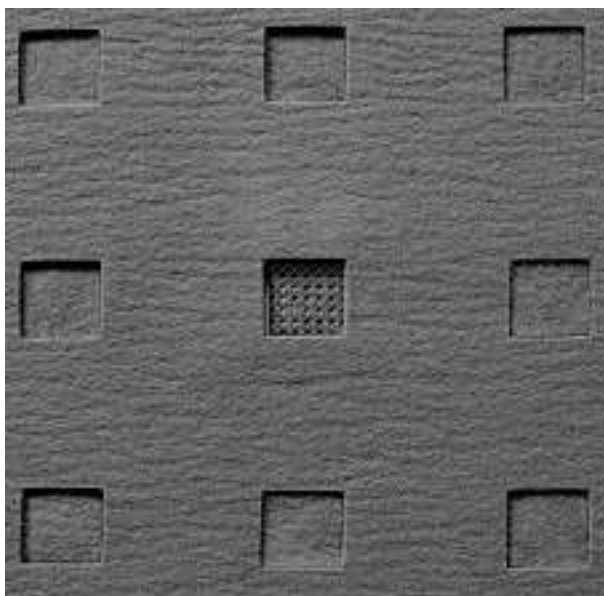

Aero LC_1

Cl. 10-07 132 245 31.10.2005
3 design – montres, bracelet pour montre
Déposant: Cyrille Marc Schmid, 359, rue de Bernex,
1233 Bernex
Fin de la période ajournement de la publication:





D-1





D-2



D-Bra

Cl. 06-01 132 278 19.10.2005
1 Design – Sessel
Hinterleger: Intertime AG, Polstermöbelfabrik, Brühlstrasse 21,
5304 Endingen
Designer: Louis Schneider, Lengnau
Ende aufgeschobene Publikation:



2616

Cl. 06-01 132 279 19.10.2005
 1 Design – Polstermöbel
 Hinterleger: Intertime AG, Polstermöbelfabrik, Brühlstrasse 21,
 5304 Endingen
 Designer: Louis Schneider, Lengnau
 Ende aufgeschobene Publikation:



2626

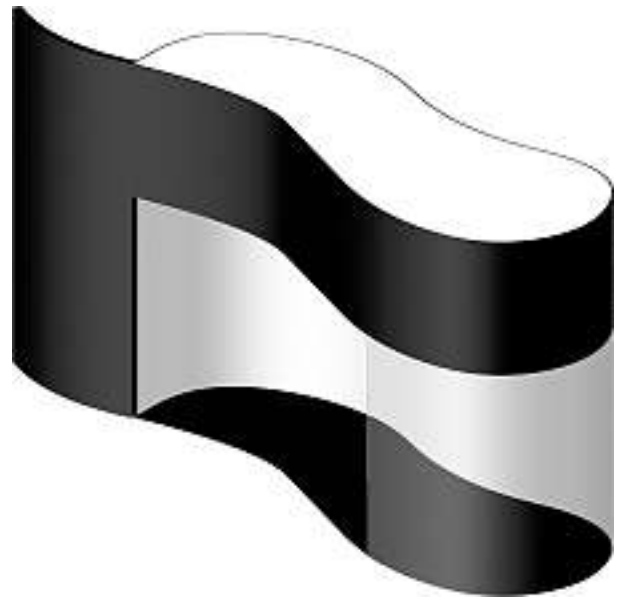

Cl. 25-03 132 374 31.10.2005
 2 Design – Wartehalle
 Hinterleger: Alfred Jörger, Trichtenhausenstrasse 120,
 8053 Zürich; Gaudenz Dobler, Glärnischstrasse 1,
 8020 Wädenswil
 Designer: Alfred Jörger, Zürich
 Vertreter: Alfred Jörger, 8053 Zürich
 Ende aufgeschobene Publikation:

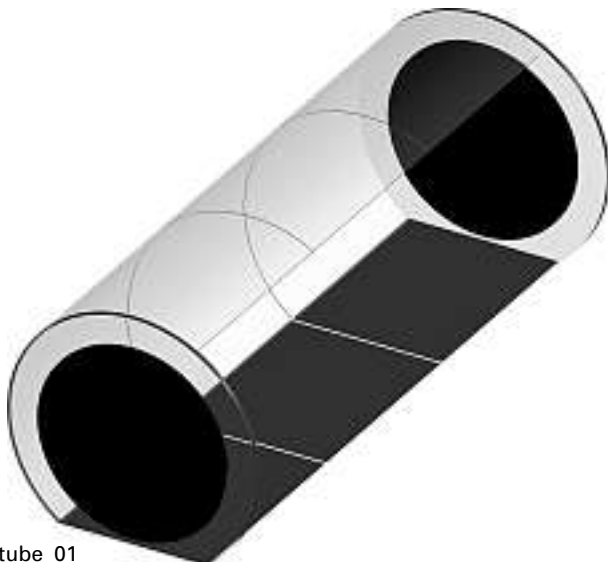

tube_01



ribbon_01

Cl. 31-00 132 448 28.11.2005
 2 Design – Kaffeemaschinen
 Hinterleger: Meyer-Hayoz Design Engineering AG,
 Jägerstrasse 2, 8406 Winterthur
 Designer: Wolfgang K. Meyer-Hayoz, Winterthur; Martin von
 Freeden, Zürich
 Vertreter: Advokatur Beutler Künzi Stutz, 3000 Bern 6
 Ende aufgeschobene Publikation:



1

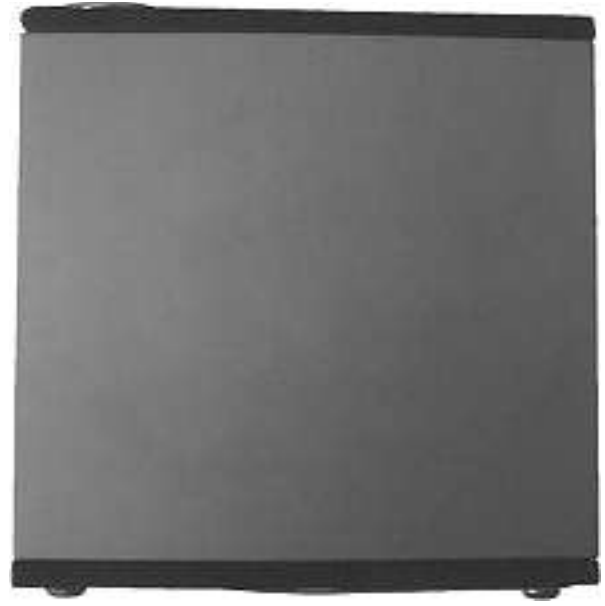

2

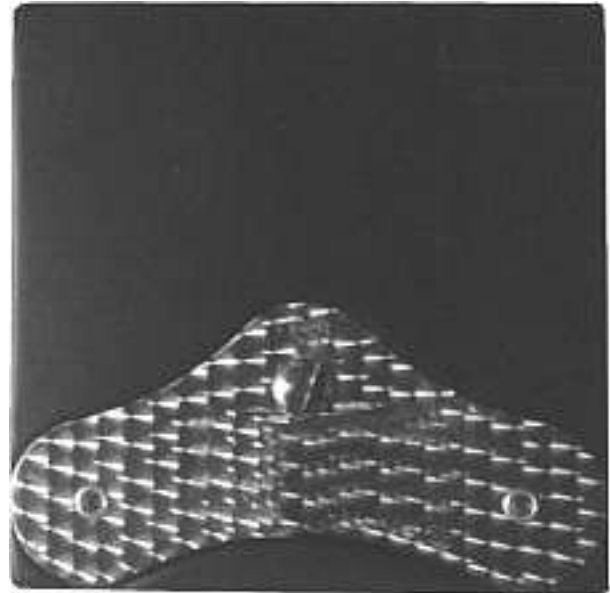

Cl. 03-01 133 136 20.09.2006
1 design – écran de montre
Déposant: Ideò Tempo SA, Rue du Lac 11, 1007 Lausanne
Designer: Philippe Subilia, Lausanne
Mandataire: Griffes Consulting S.A., 1206 Genève
Fin de la période ajournement de la publication:





0055-MO-0027-CH-CH-01



Cl. 02-02 **134 877** 03.03.2008
1 Design – Kleidungsstück
Hinterleger: CAMAS PR GmbH, St.Gallerstrasse 104b,
9032 Engelburg
Designer: Jörg Caluori, Engelburg

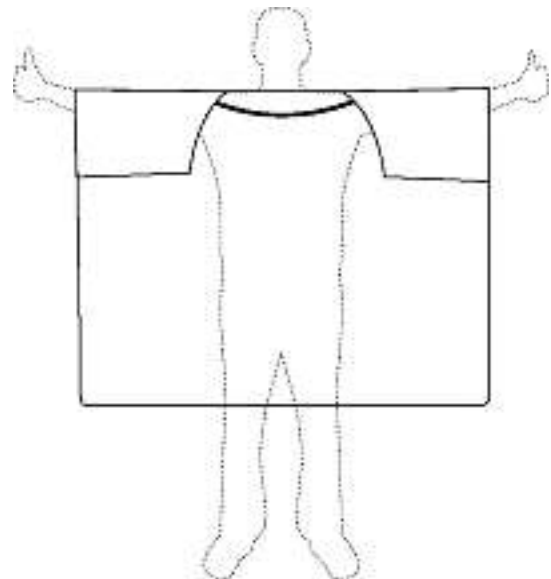

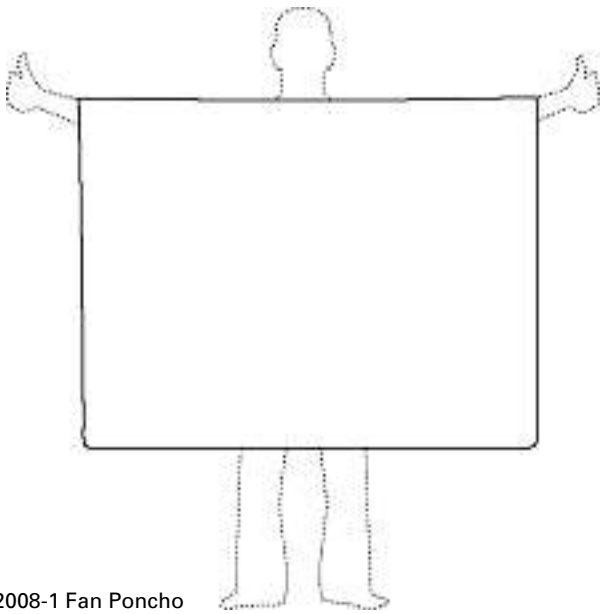

2008-1 Fan Poncho

Cl. 02-02 134 878 10.03.2008
2 Design - Mäntel
Hinterleger: Bettina Looser, Weinsteig 56, 8200 Schaffhausen





A





B

Cl. 02-02 **134 879** 12.03.2008
2 design – partie d'un vêtement
Déposant: ARCCO design Sàrl, Ch. de la Brume 2,
Case postale 3065, 1110 Morges 3
Designer: Yuk Piu Lau, Morges

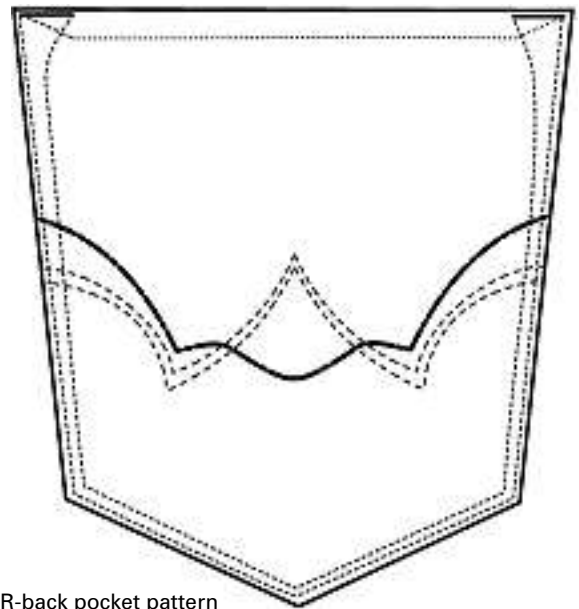

AR-back pocket pattern

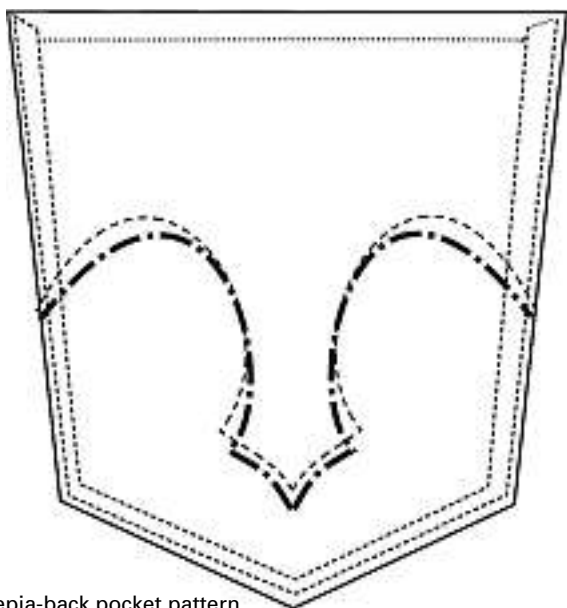

Sepia-back pocket pattern

Cl. 02-02 134 880 17.03.2008

2 Design – T-Shirt

Hinterleger: SAFP Swiss Association of Football Players, Bellerivestrasse 201, 8034 Zürich; Swiss Association of Icehockey Players (SAIP), Bellerivestrasse 201, 8034 Zürich
 Designer: Christian Paredes, Richterswil
 Vertreter: Froriep Renggli, Rechtsanwältin, 8034 Zürich



T-Shirt SAFP

Cl. 03-01 134 881 06.03.2008

2 Design – Taschen

Hinterleger: Pascal Juplé, Stegweidstrasse 2, 8496 Steg im Tösstal



T-Shirt saip



kurz



lang

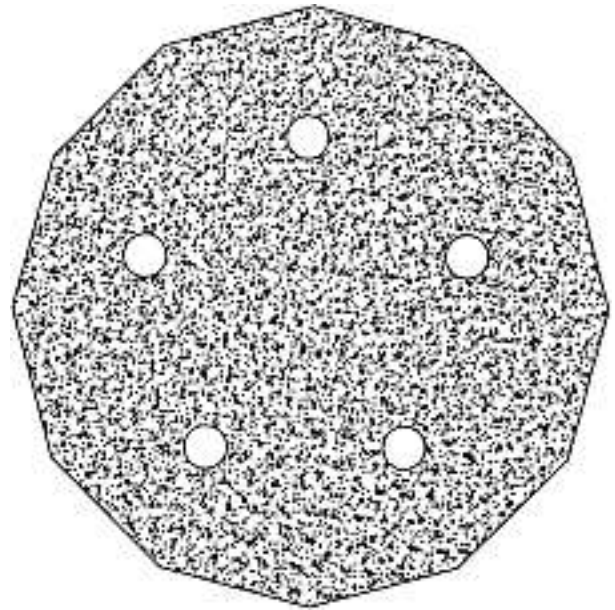

M13484-2

Cl. 05-06 **134 882** 20.03.2008
9 Design – Schleifpapier
Hinterleger: KWH MIRKA LTD, Pensalavägen 210,
66850 Jeppo, FI
Designer: Göran Höglund, Nykarleby
Vertreter: Isler & Pedrazzini AG, 8027 Zürich
Priorität: EM, 18.12.2007; EM, 18.12.2007; EM, 18.12.2007;
EM, 18.12.2007; EM, 18.12.2007; EM, 18.12.2007; EM,
18.12.2007; EM, 18.12.2007; EM, 18.12.2007

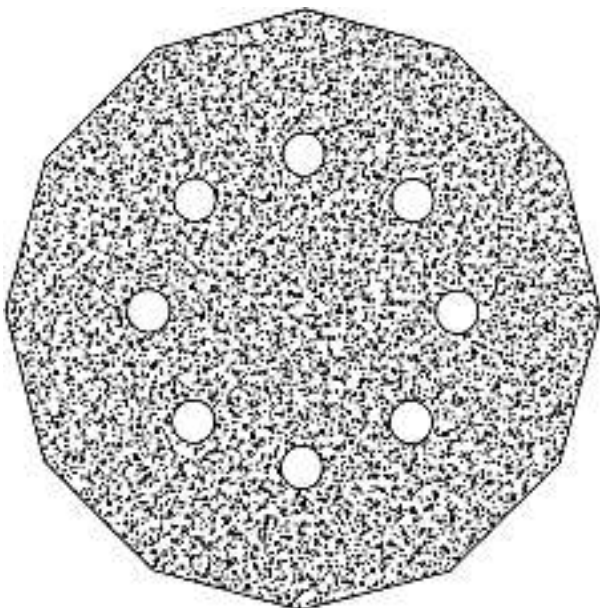

M13484-1

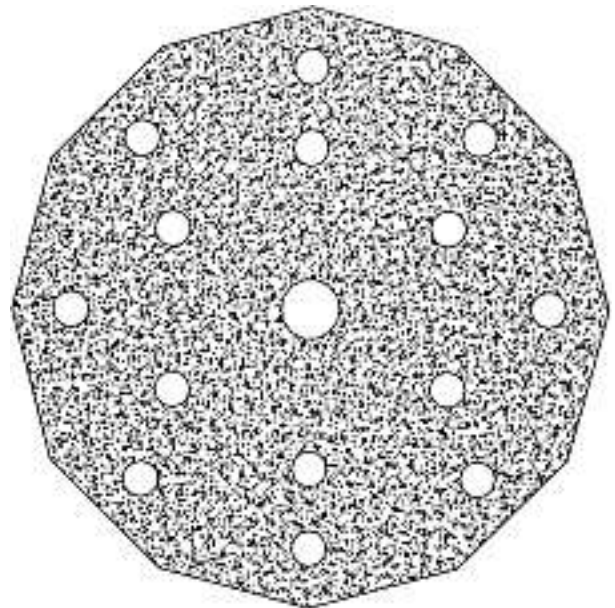

M13484-3

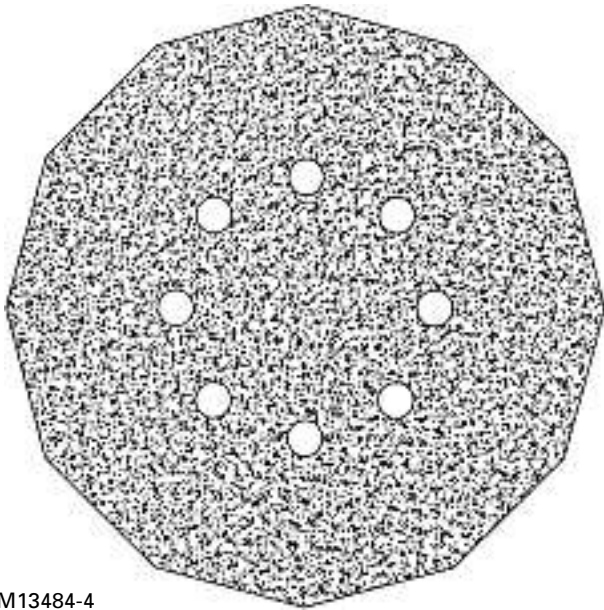

M13484-4

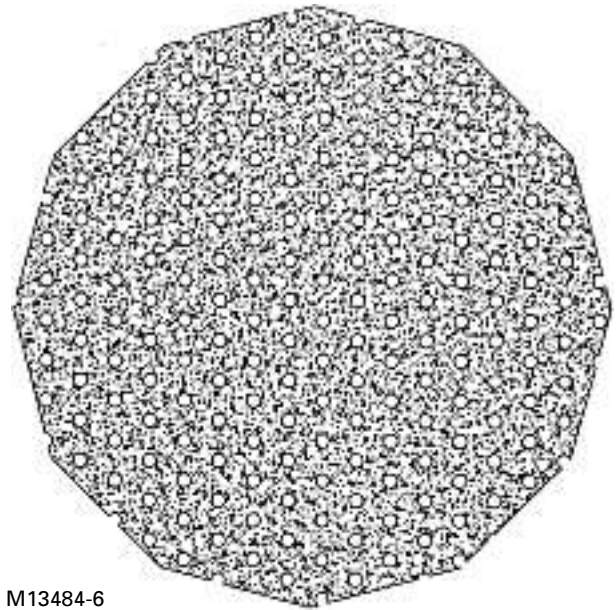

M13484-6

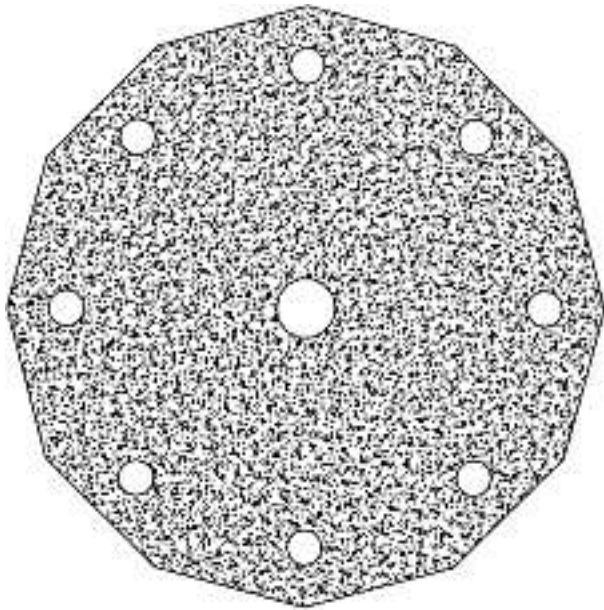

M13484-5

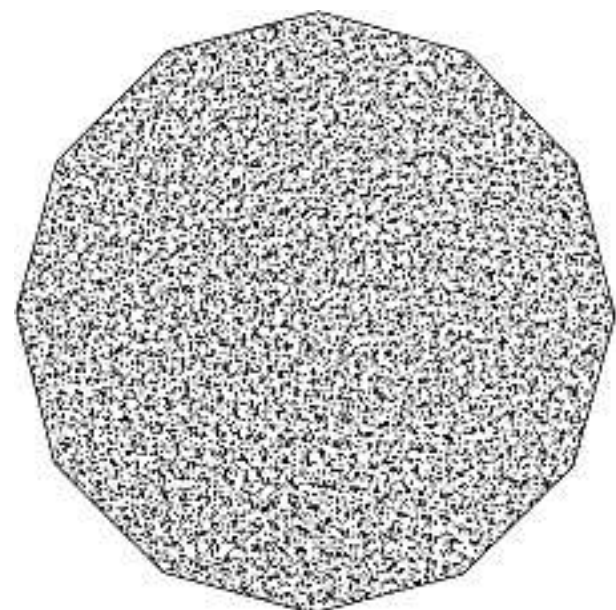

M13484-7

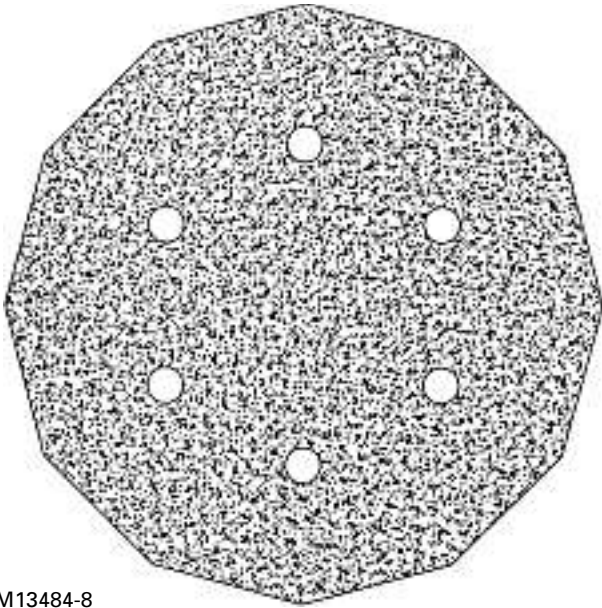

M13484-8

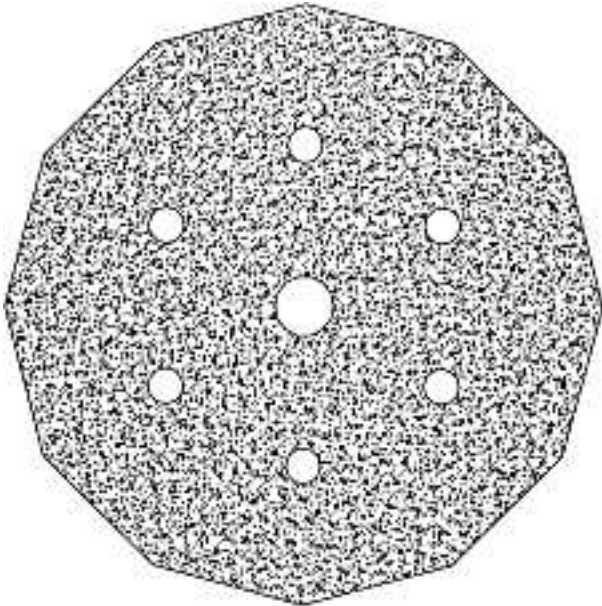

M13484-9

Cl. 06-01 134 883 21.01.2008
 2 Design – Kindersitz
 Hinterleger: RECARO GmbH & Co. KG, Stuttgarter Strasse 73,
 73230 Kirchheim unter Teck, DE
 Designer: Jürgen Schrödel, Schwarzenbrück
 Vertreter: Patentanwalt Dipl.-Ing. (Uni) Wolfgang Heisel,
 8570 Weinfeldern
 Priorität: EM, 06.08.2007







2

Cl. 06-01 134 884 13.03.2008

1 Design – Stuhl

Hinterleger: Vitra Patente AG, Klüfenfeldstrasse 22,
4132 Muttenz

Designer: Erwan Bouroullec, Paris; Ronan Bouroullec, Paris

Vertreter: AXON Patent GmbH, 4147 Aesch







1

Cl. 06-03 134 885 13.03.2008
2 Design - Tische
Hinterleger: Ekornes ASA, 6222 Ikorntnes, NO
Designer: Marianne Saelid, Ikorntnes; Jan Lade, Ikorntnes
Vertreter: Frei Patentanwaltsbüro AG, 8032 Zürich
Priorität: NO, 19.10.2007

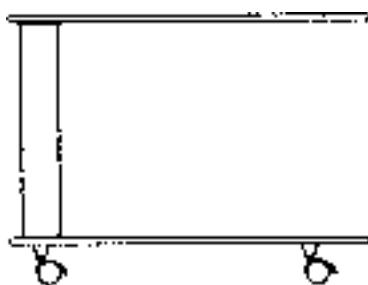
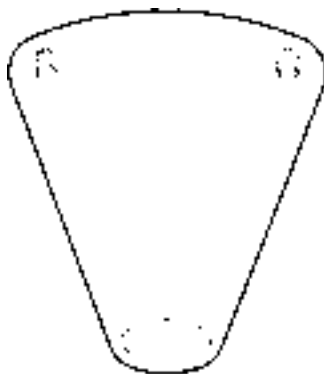
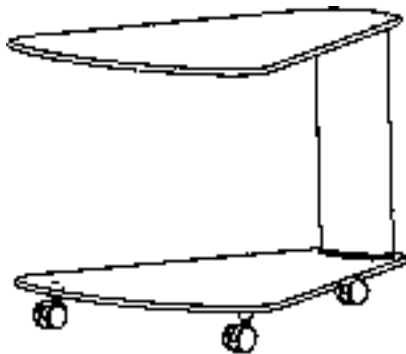
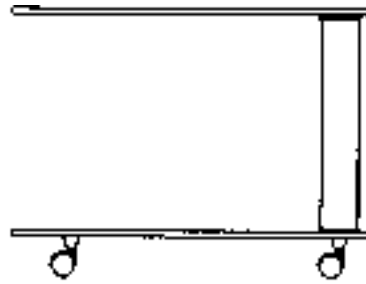
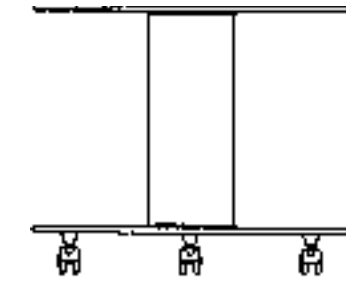

1

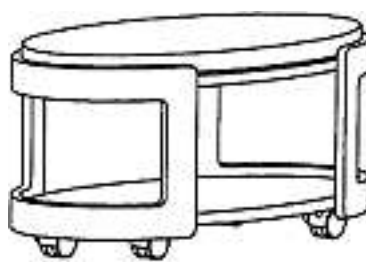
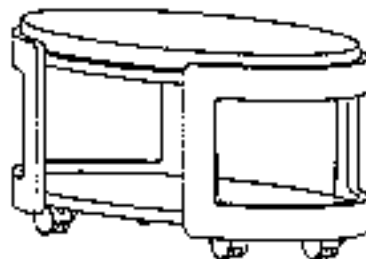
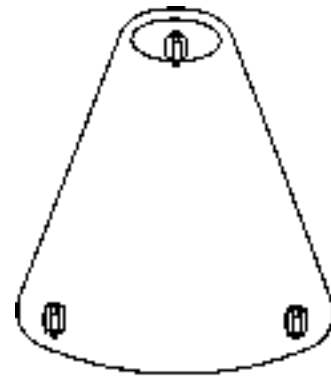

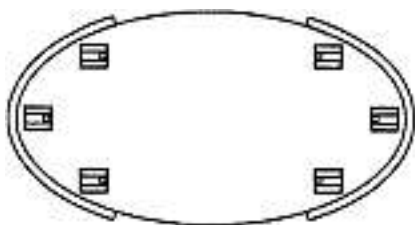
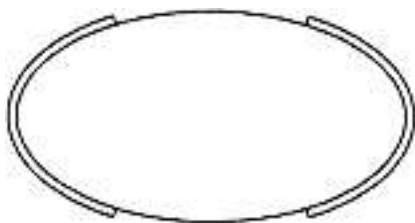
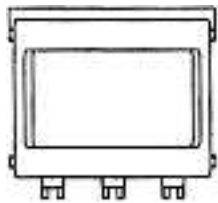
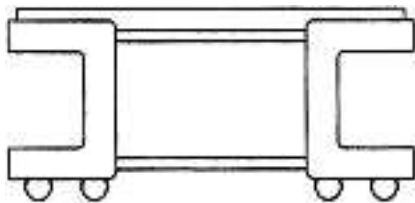
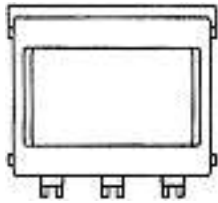
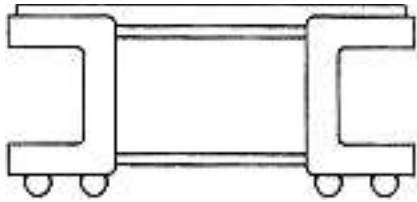

2

Cl. 06-04 **134 886** 25.02.2008
 1 Design – Unterhaltungselektronik-Möbel
 Hinterleger: Romeo Csaba Kallos, Ringstrasse 4,
 4414 Füllinsdorf

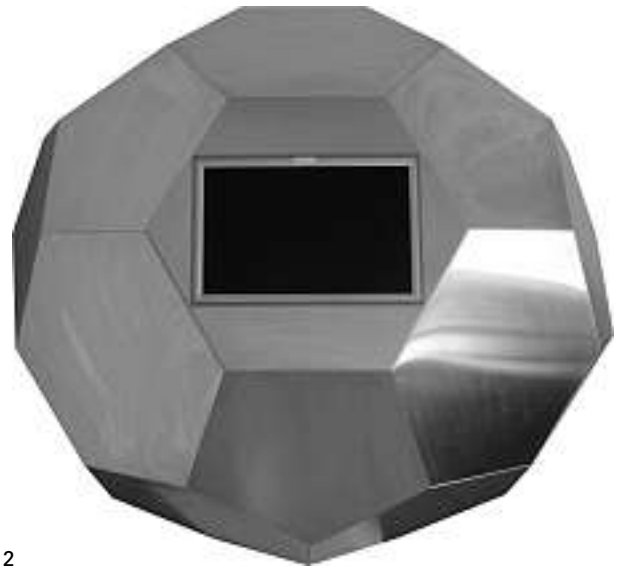

2

Cl. 06-04 **134 887** 17.03.2008
 1 Design – Regal
 Hinterleger: Harald Schaffer, Gempenweg 7, 4144 Arlesheim



MG2.000

Cl. 07-01 **134 889** 13.03.2008
 3 Design – Lebensmittel-Aufbewahrungs-Behälter
 Hinterleger: Korea Alphaline Co. Ltd., 435-5 Dunchon-dong,
 Kangdong-ku, Seoul 134-060, KR
 Designer: Soo Chang Wang, Seoul
 Vertreter: Patentbüro Paul Rosenich Aktiengesellschaft (PPR),
 Triesenberg (LI), Zweigniederlassung Buchs SG,
 9470 Buchs SG
 Priorität: KR, 21.09.2007

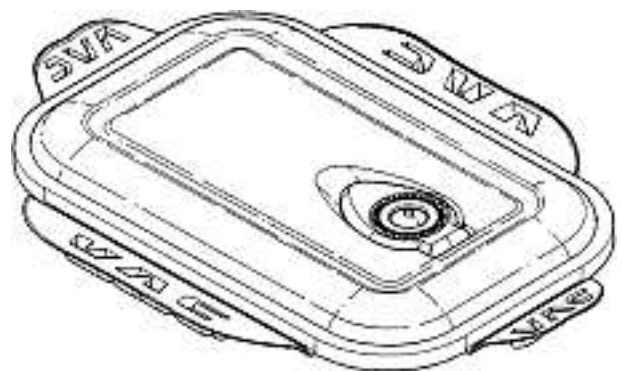
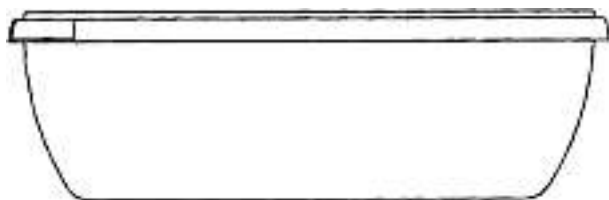
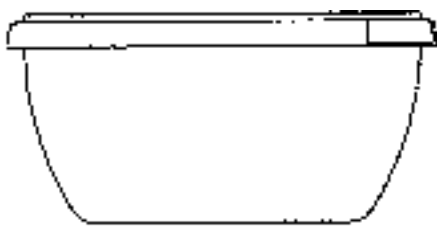
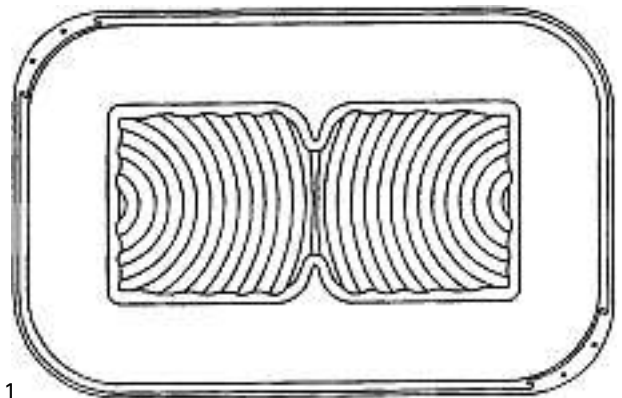
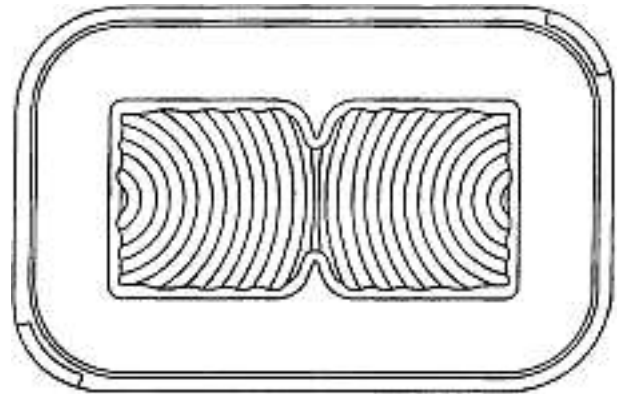
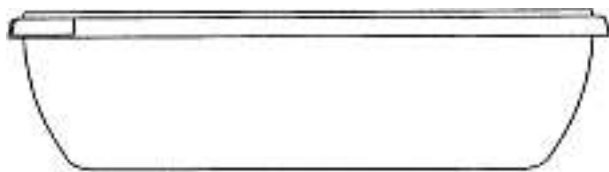
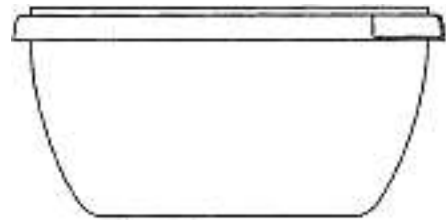
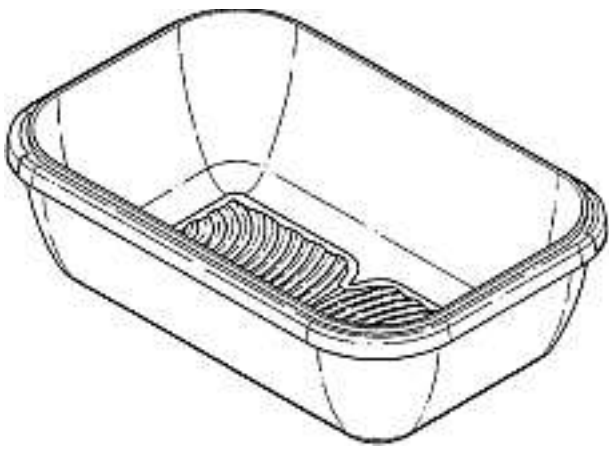

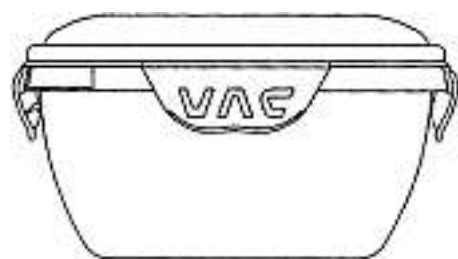
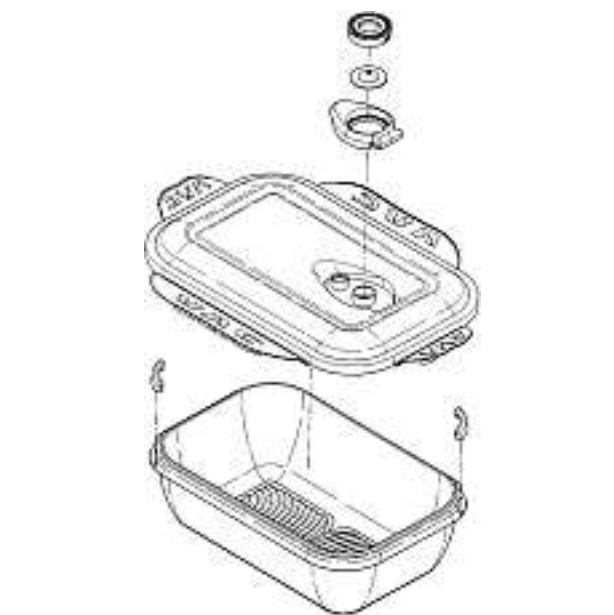
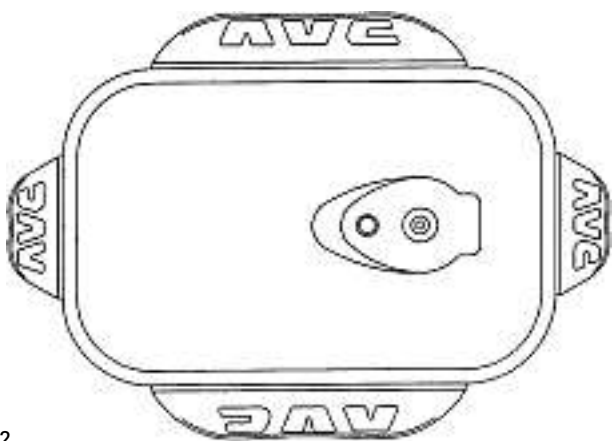
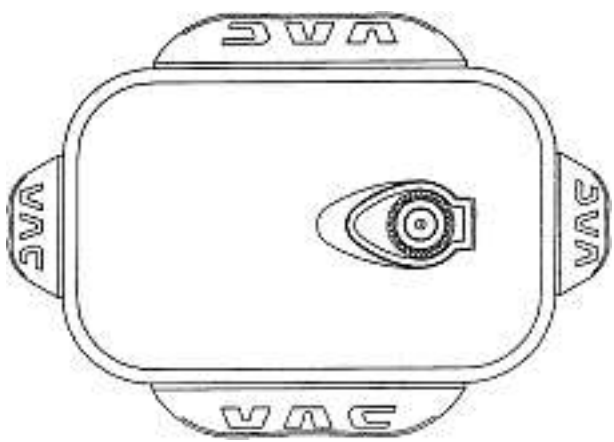
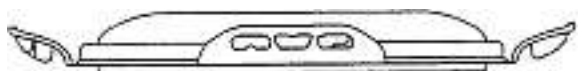

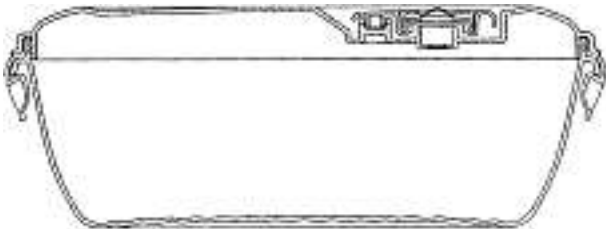
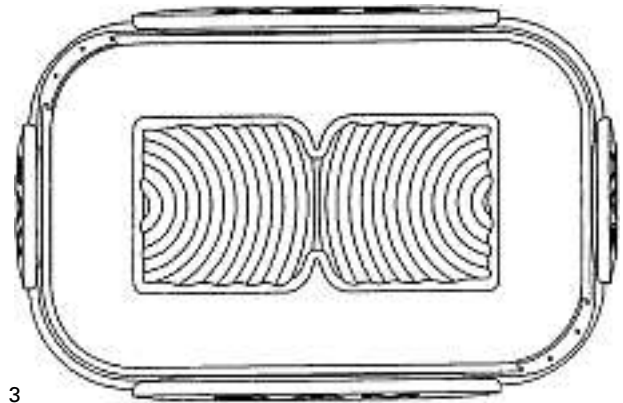
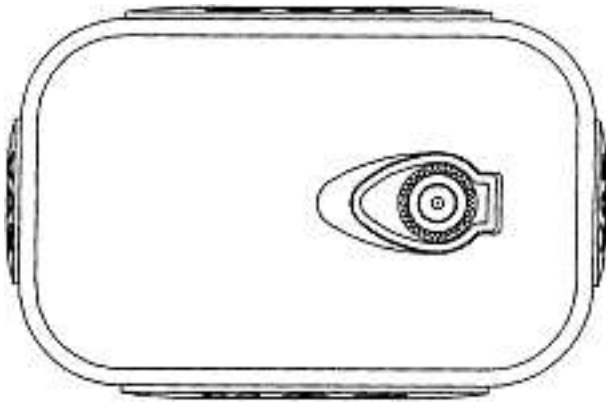

Cl. 07-02 134 890 13.03.2008
1 Design – Grillpfännchen
Hinterleger: Iglu of Switzerland AG, Hofackerstrasse 16,
4313 Möhlin
Designer: Kurt Zimmerli, Warth
Vertreter: Felber & Partner AG, 8034 Zürich

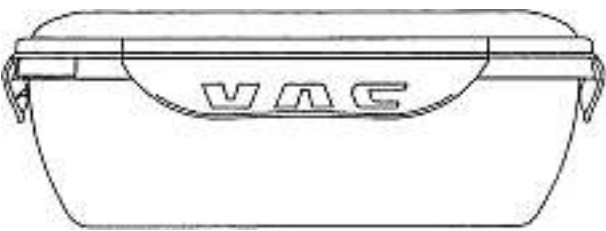



1

Cl. 08-06 **134 891** 07.03.2008
 2 Design – Möbelknöpfe
 Hinterleger: Ewa Louis, Schachenwald 801, 9063 Stein AR



CORPO 1

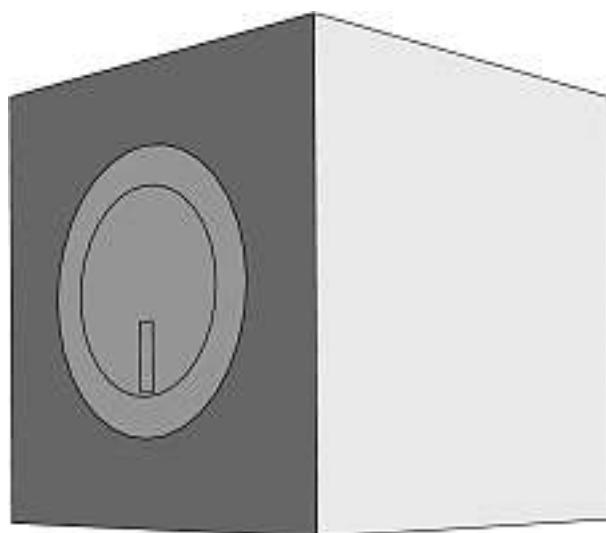

CORPO 2

Cl. 08-06 **134 892** 11.03.2008
 3 Design – Fenstergriff, Türgriff
 Hinterleger: Hoppe AG, Jaufenstrasse 16, St. Martin im
 Passeier, IT
 Designer: Alessandro Terzariol, Klausen; Mario Varesco,
 Bozen; Günther Kuhn, Bozen
 Vertreter: PA Aldo Römpler, 9410 Heiden
 Priorität: EM, 27.09.2007





TG 1768

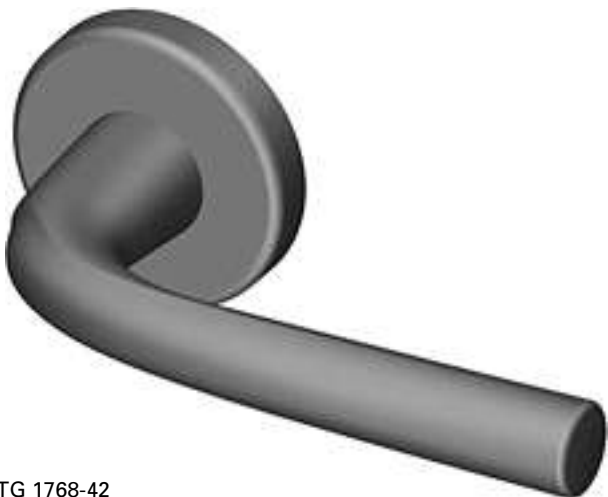

TG 1768-42



TG 0768/U23

Cl. 08-08 134 893 04.03.2008
1 Design – Montageplatte
Hinterleger: Jürg Nigg, Beckenhofstrasse 30, 8006 Zürich

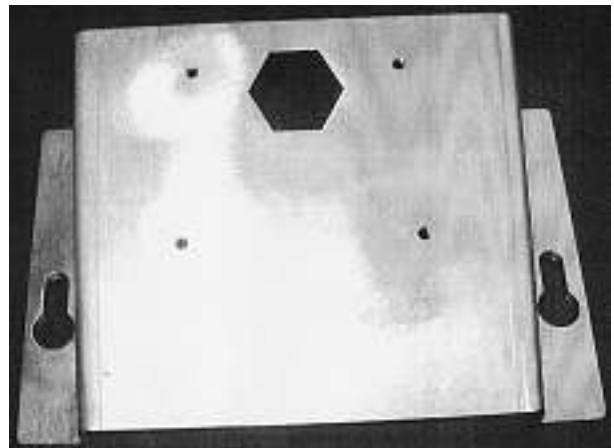
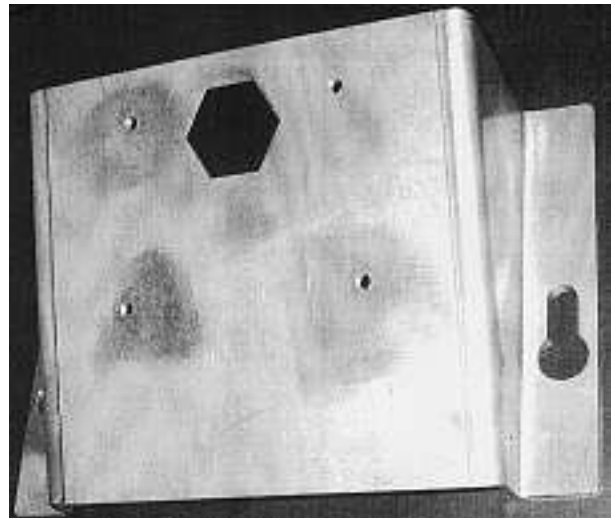

080304/1032

Cl. 09-03 **134 894** 06.03.2008
 1 design – élément décoratif pour emballages
 Déposant: Société des Produits Nestlé SA, 1800 Vevey
 Designer: Gregory Steiger, La Tour-de-Peilz
 Mandataire: Nestec S.A., 1800 Vevey

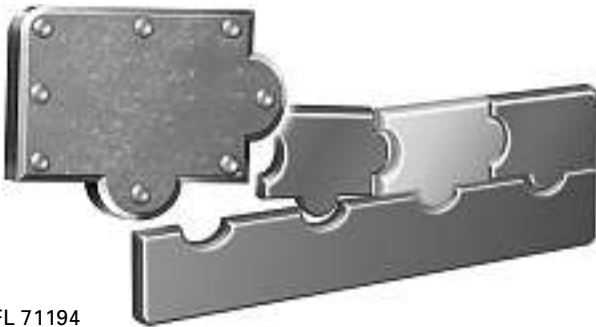

FL 71194



1

Cl. 09-03 **134 895** 10.03.2008
 2 Design – Schachtel für Papiertücher
 Hinterleger: Kimberly-Clark Limited, 1 Tower View, Kings Hill,
 West Malling, Kent ME19 4HA, GB
 Designer: Dennis Fryer, Ashford; Emma Leech, London;
 Marc Zander, Reigate
 Vertreter: BOHEST AG, 4003 Basel

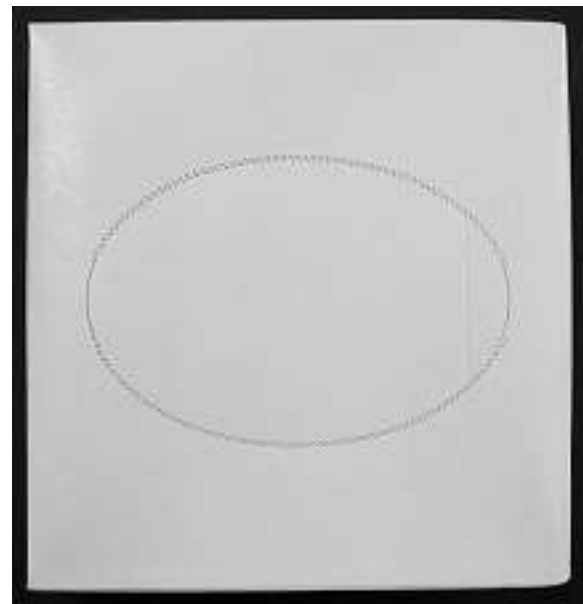
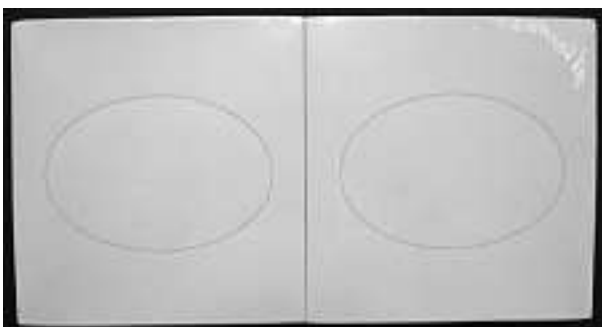



2

Cl. 09-09 **134 898** 04.03.2008
 2 Design – Abfallbehälter
 Hinterleger: Werner Zemp, Rehweg 2, 8044 Gockhausen

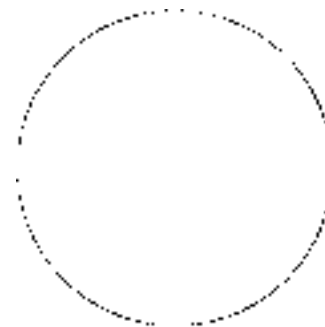
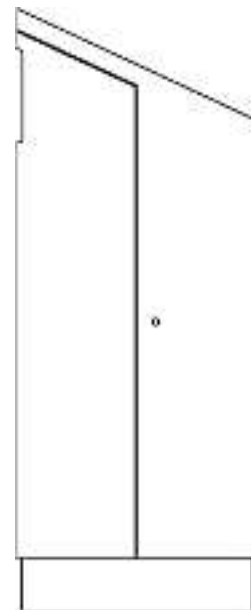

Cl. 09-03 **134 896** 17.03.2008
 1 Design – Verpackungsbemusterung
 Hinterleger: Martin W. Duppenhaller, c/o S. Wolf, Reinertstrasse 47, 4515 Oberdorf SO
 Designer: Adam David Buckner, Albuquerque



2 (Tray & Transport Design)

Cl. 09-03 **134 897** 17.03.2008
 1 Design – Verpackungsbemusterung
 Hinterleger: Martin W. Duppenhaller, c/o S. Wolf, Reinertstrasse 47, 4515 Oberdorf SO
 Designer: Adam David Buckner, Albuquerque



3 (Can Design)

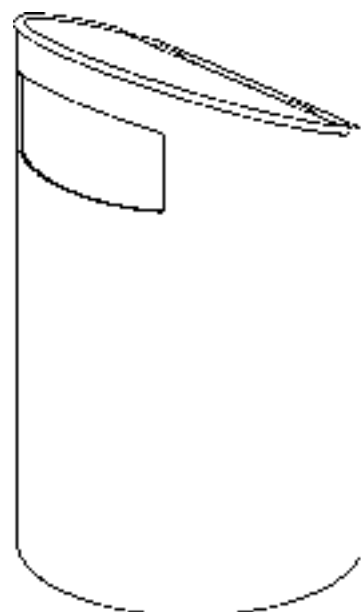
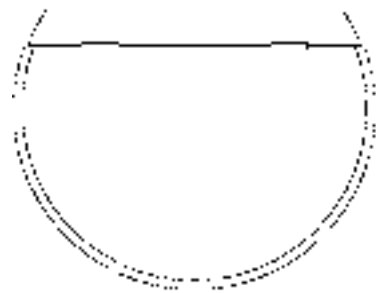
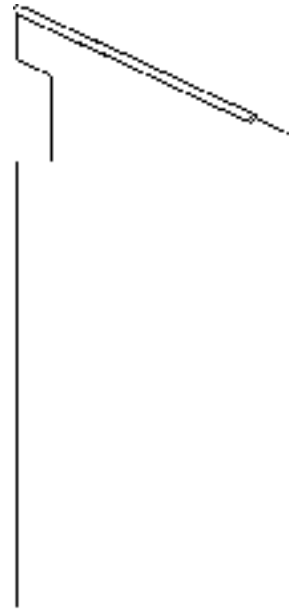
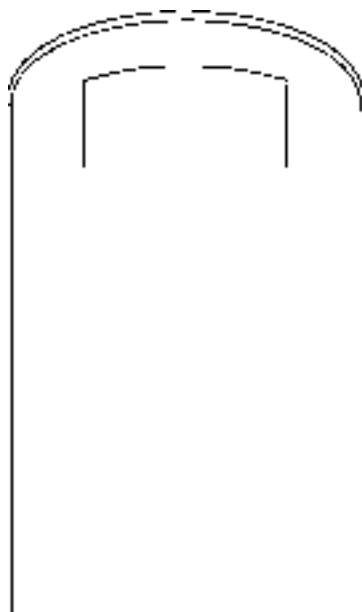
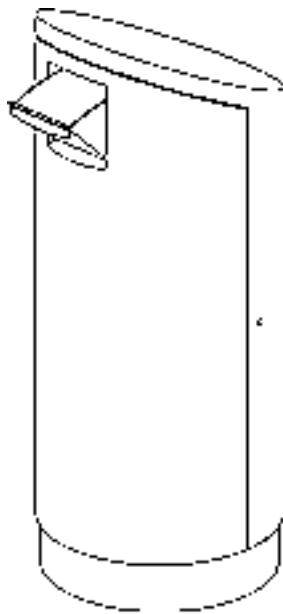
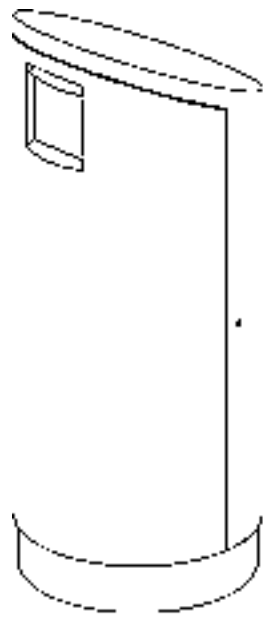

1

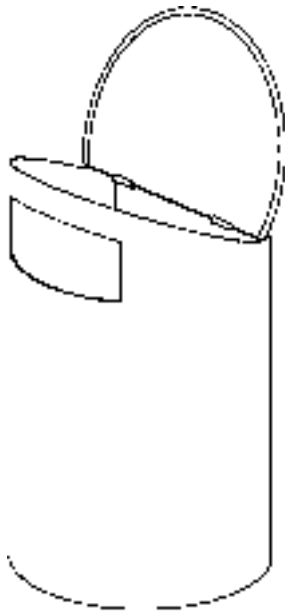

2

Cl. 09-09 **134 899** 05.03.2008
3 Design – Abfall-, Wertstoffsammelvorrichtung
Hinterleger: Pöttinger Entsorgungstechnik GmbH & Co. KG,
Industriestrasse 30, 4710 Grieskirchen, AT
Designer: Johann Erler, Pram; Johann Zehetner, Pollham;
Martin Baldinger, Peuerbach
Vertreter: Bovard AG, 3000 Bern 25

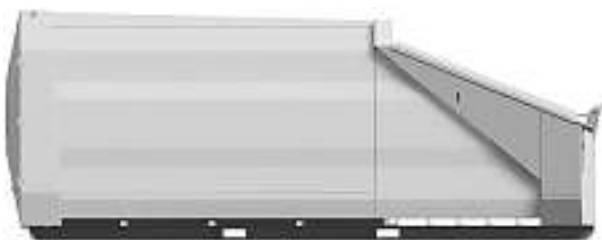
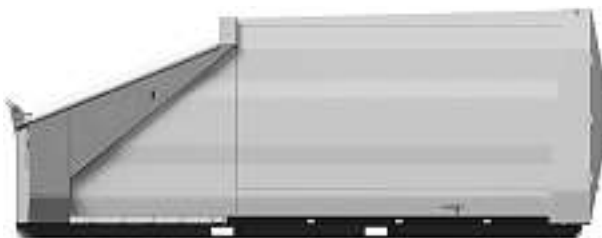

1

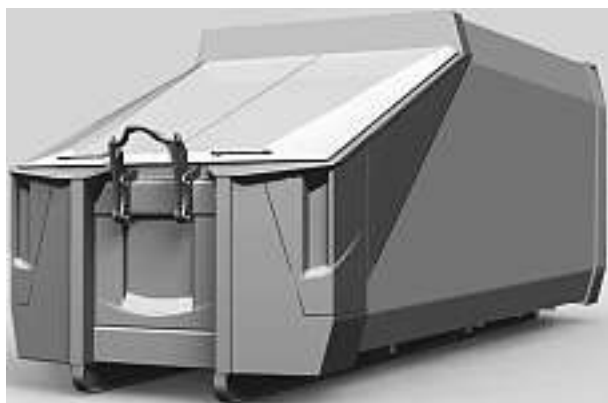

2



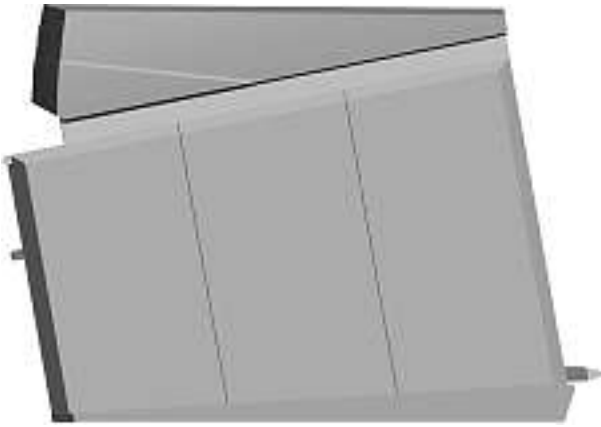

3

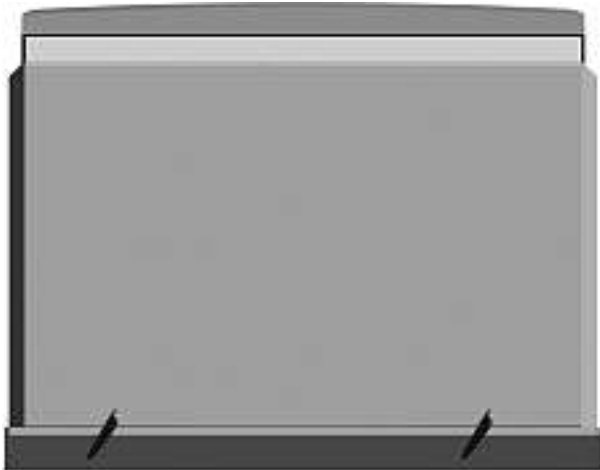

Cl. 10-02, 10-07 **134 900** 12.03.2008
 6 Design – Uhren
 Hinterleger: Invicta Watch Company of America, Inc.,
 a Florida Corporation, 3069 Taft Street, Hollywood,
 Florida 33021, US
 Designer: Eyal Lalo, Hollywood
 Vertreter: Troesch Scheidegger Werner AG, Patent- und
 Markenanwälte, 8126 Zumikon

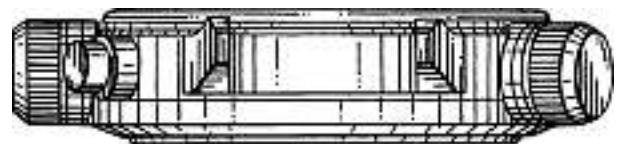
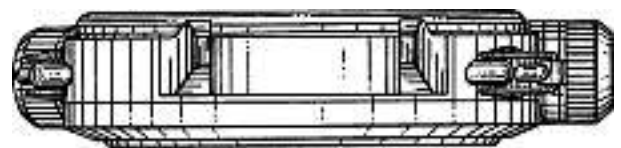
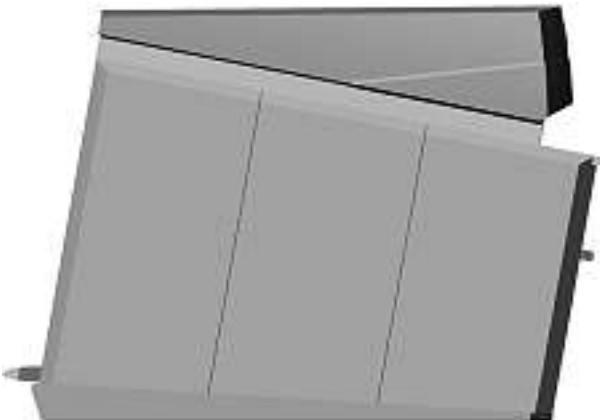

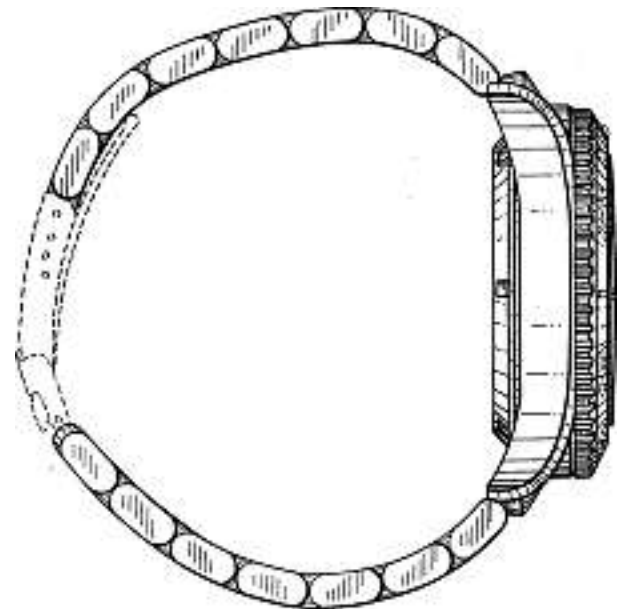
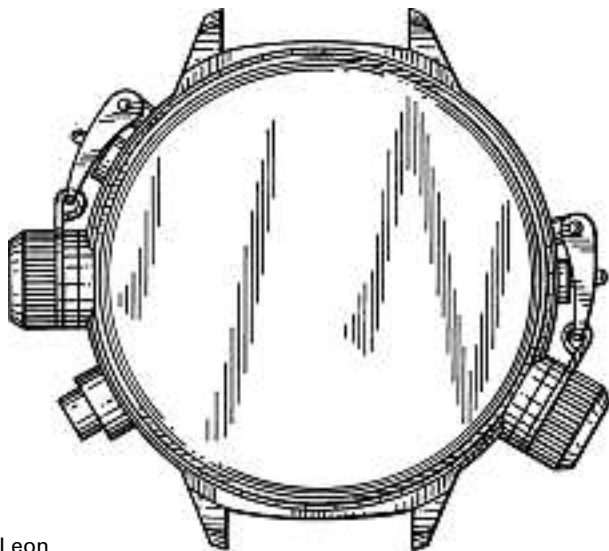
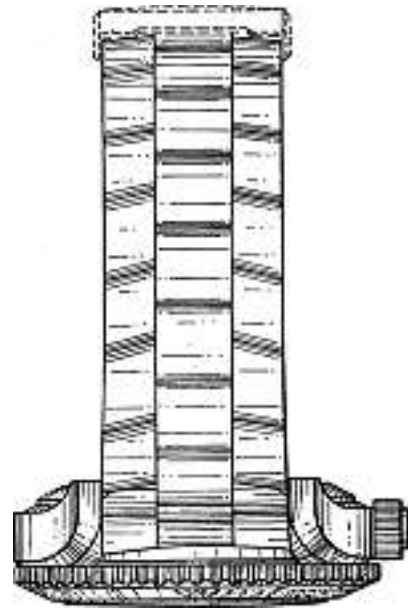
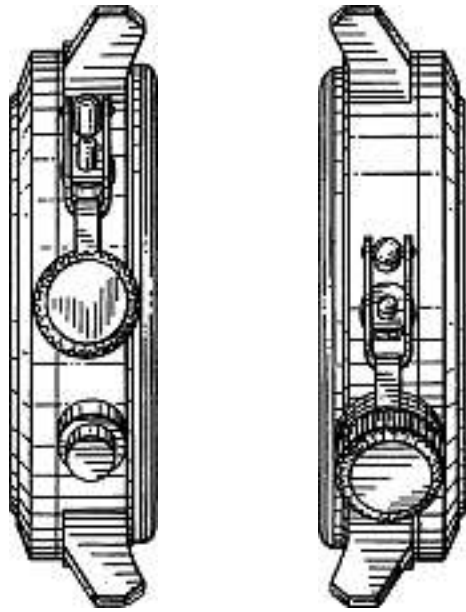

Leon

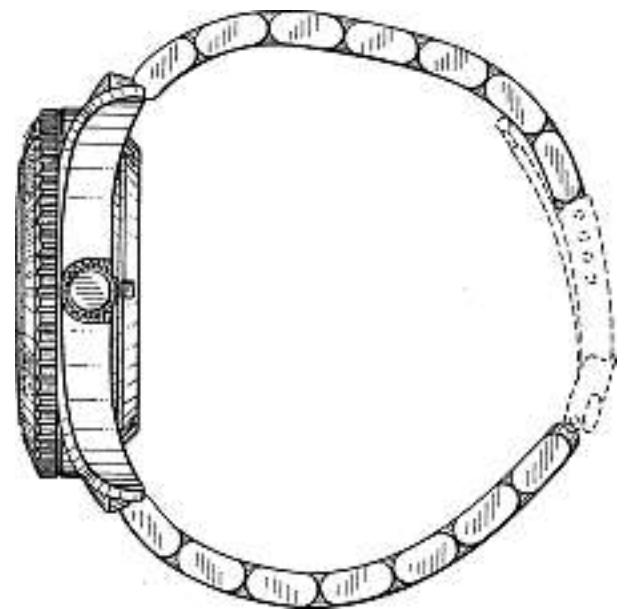

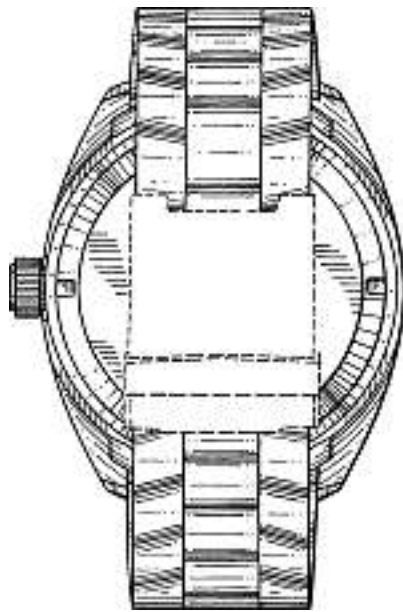

Prodiver

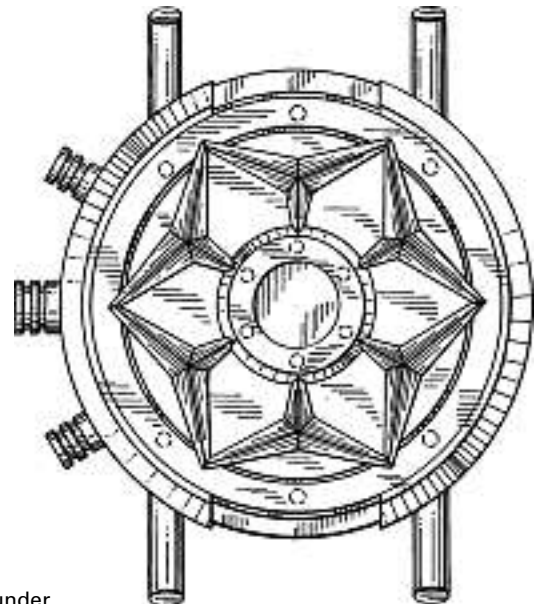
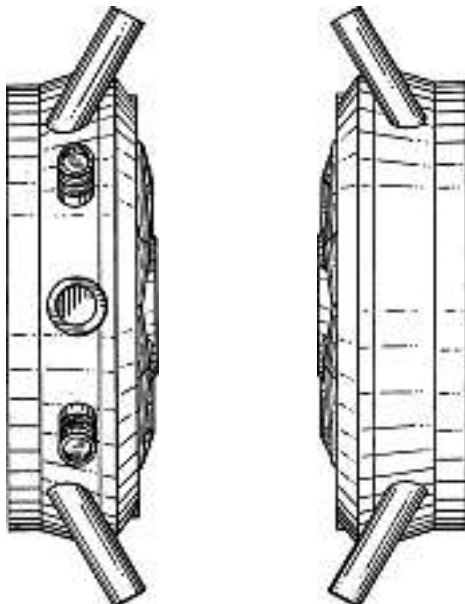
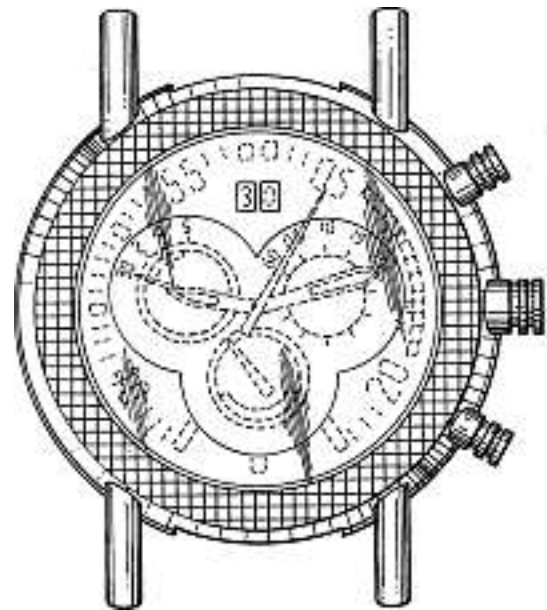
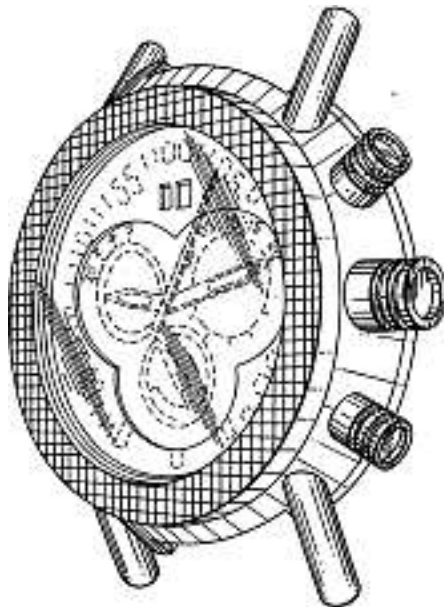

Rounder

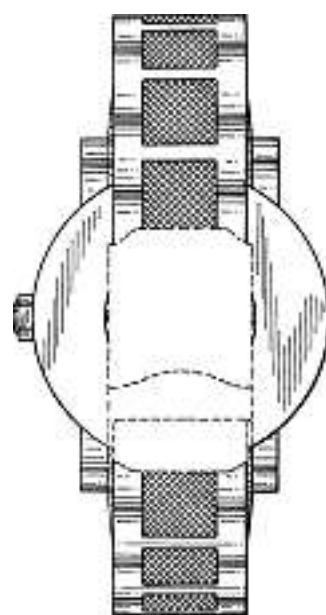
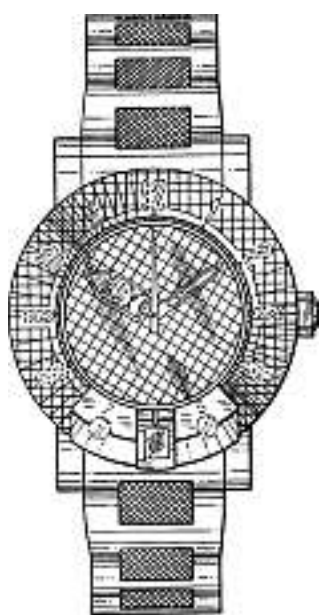
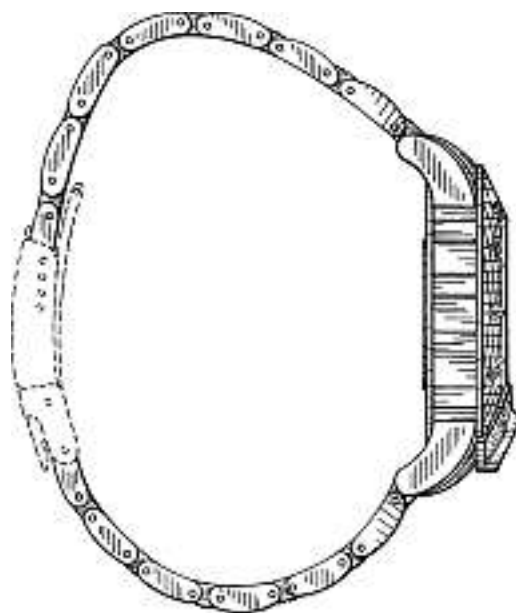
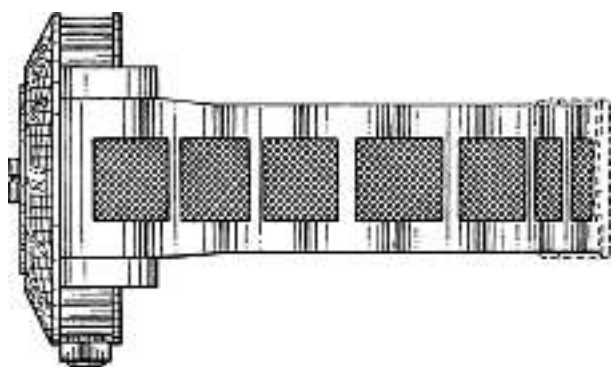
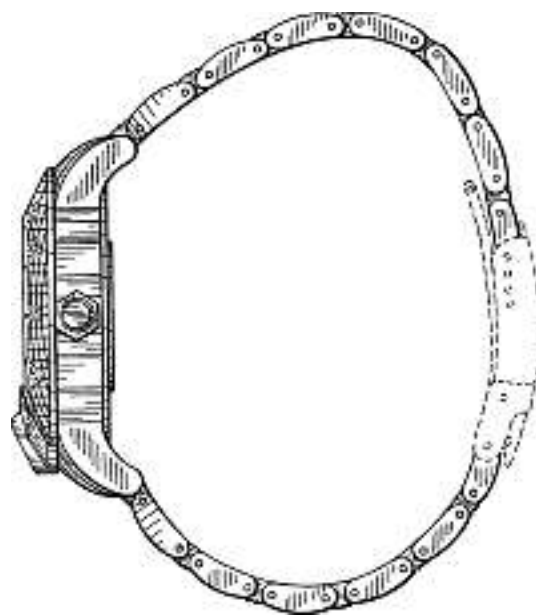

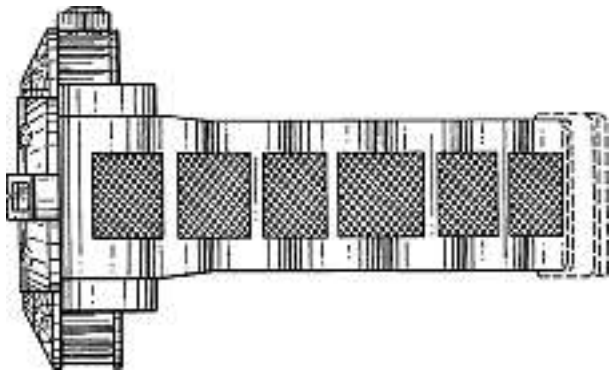

Skeleton

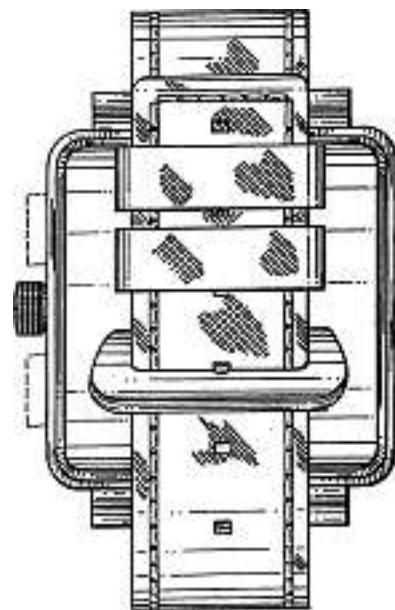
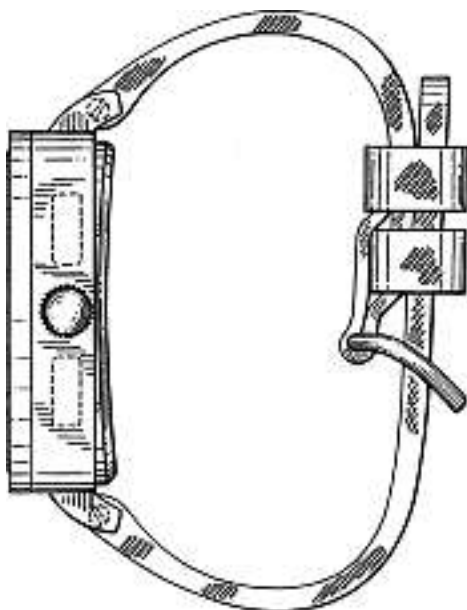
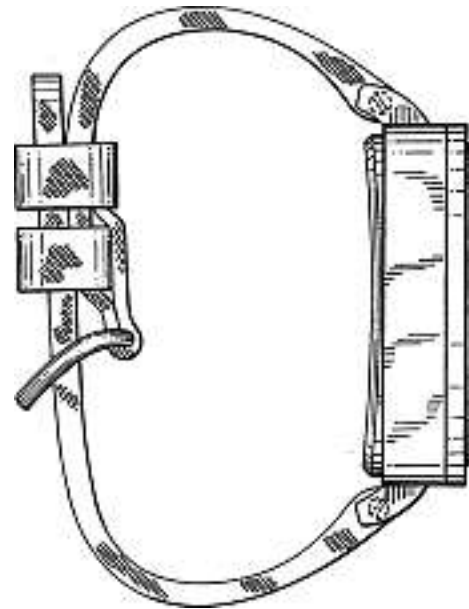
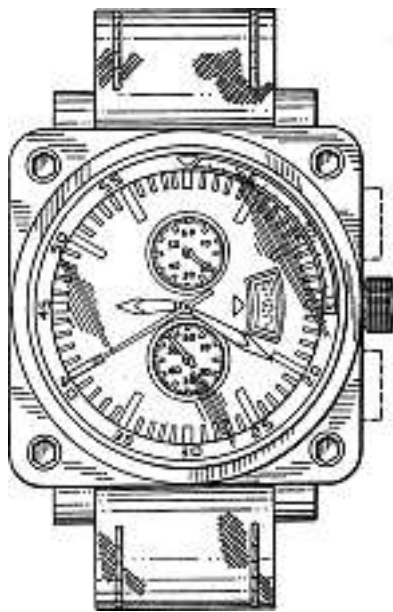
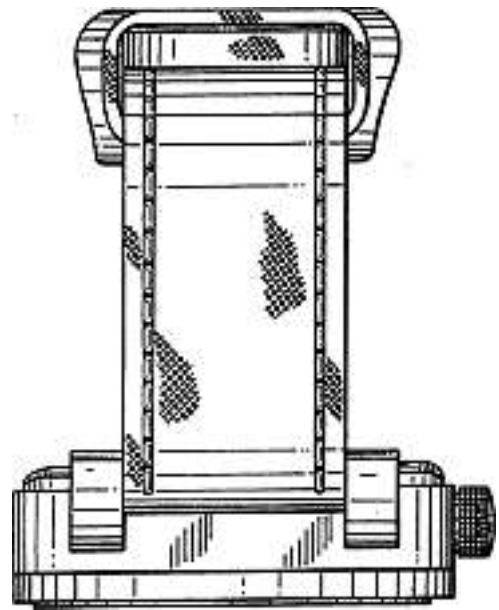

Toledo 1

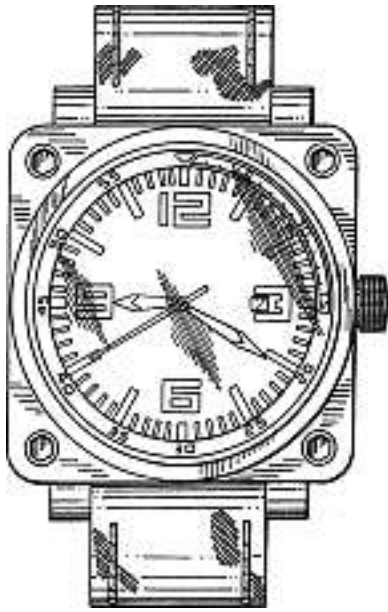

Toledo 2



Cl. 10-02 **134 901** 16.04.2008
 3 design – montres-bracelets
 Déposant: HUBLOT SA, Genève, rue de la Fontaine 7,
 1204 Genève
 Designer: Carlo Crocco, Lugano
 Mandataire: Inteltech SA, 2001 Neuchâtel



1





2





3

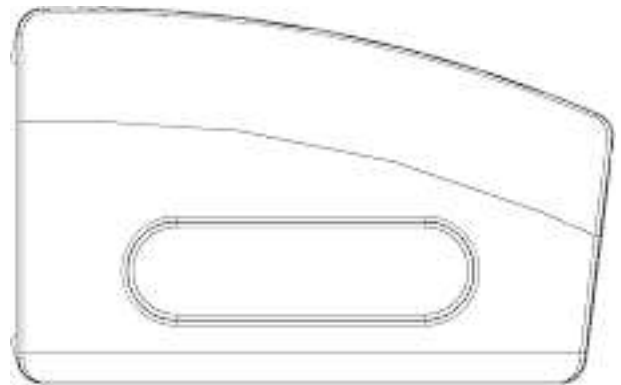
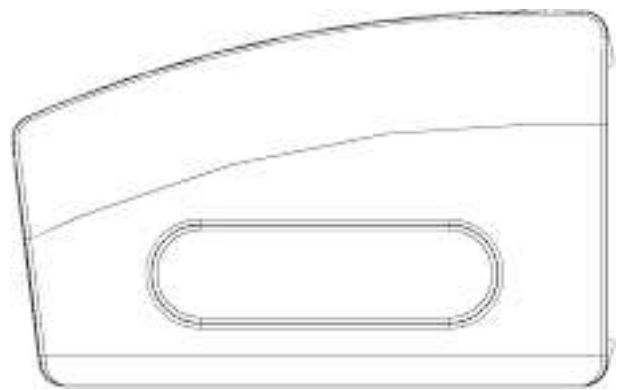

1

Cl. 10-04 **134 902** 11.03.2008
 6 Design – Sensor
 Hinterleger: SICK AG, Erwin-Sick-Strasse 1,
 79183 Waldkirch, DE
 Designer: Ralf Friedrich, Biengen; Frank Detering, Stuttgart;
 Christof J. Meyer, Gutach-Bleibach
 Vertreter: Keller & Partner, Patentanwälte AG, 3000 Bern 7
 Priorität: EM, 06.02.2008

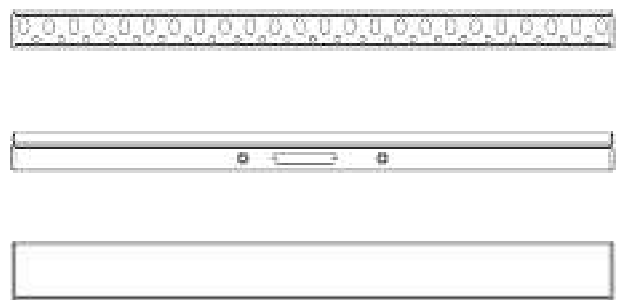
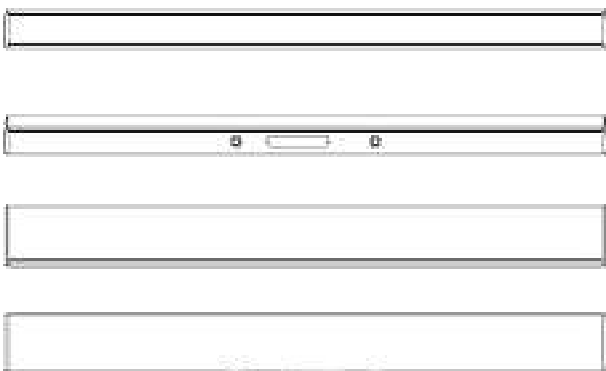

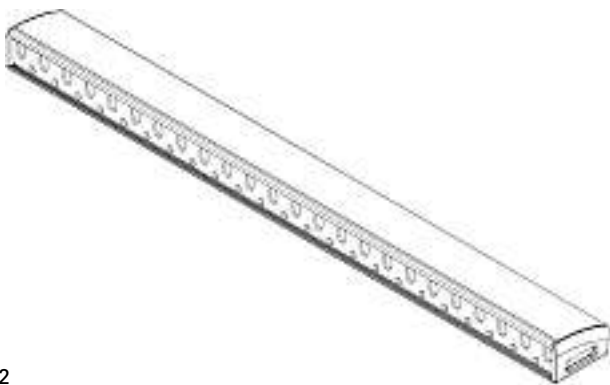
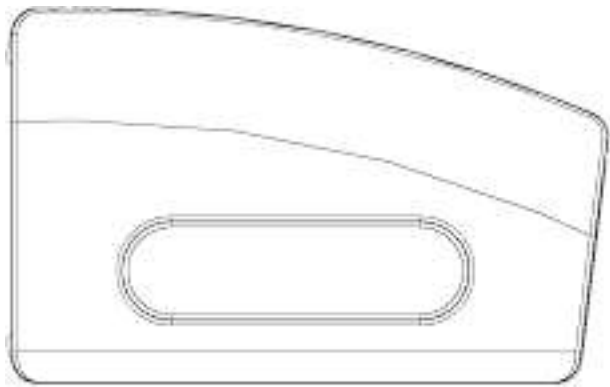
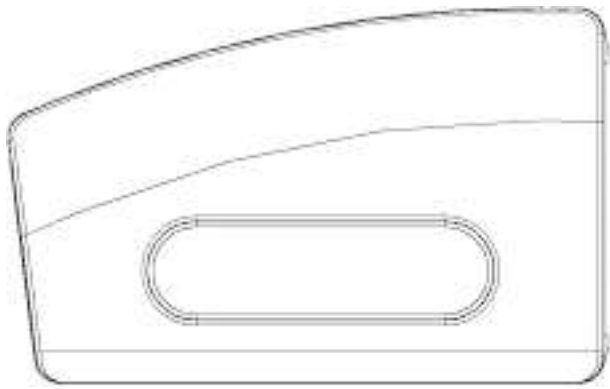

2

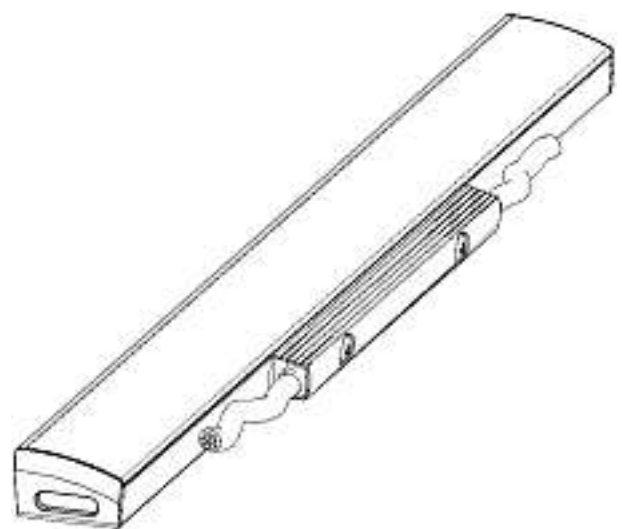
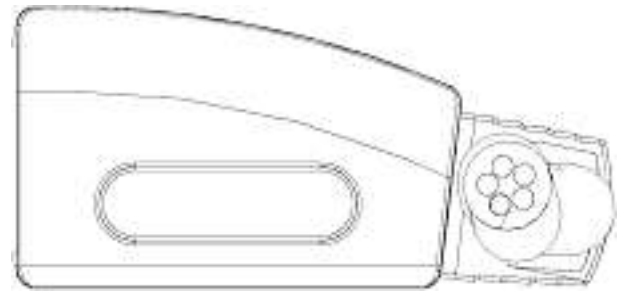
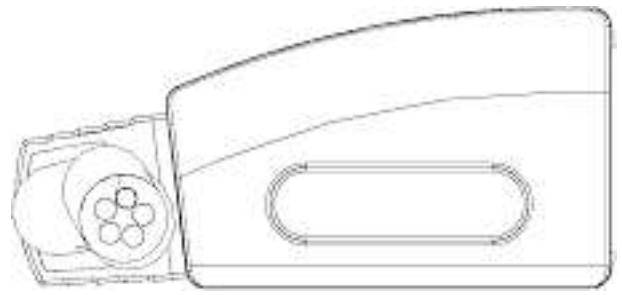

3



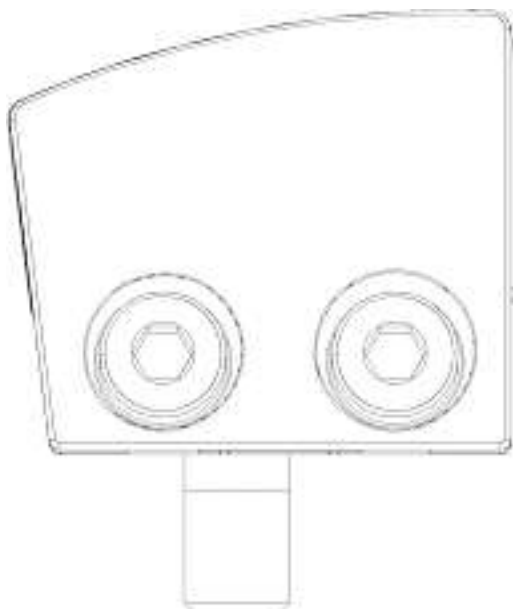

4

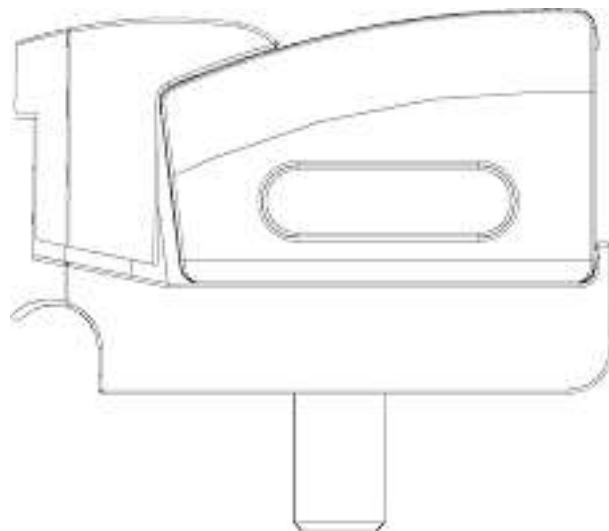
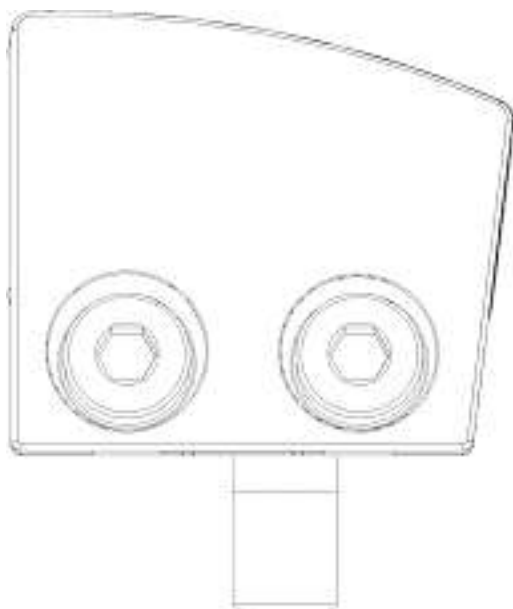
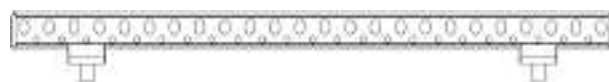

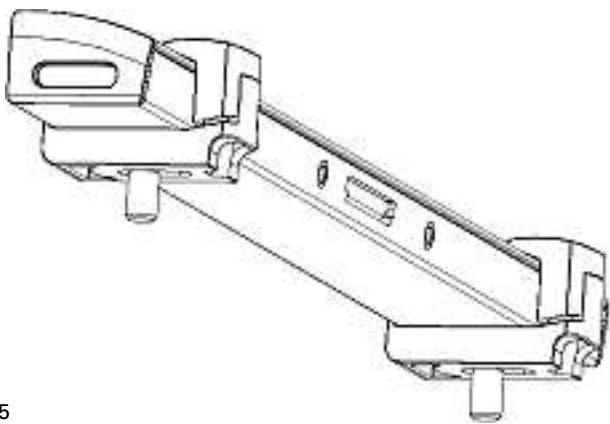
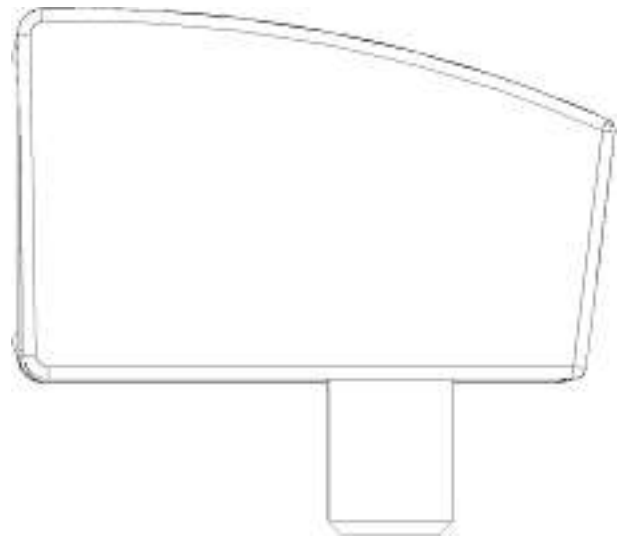
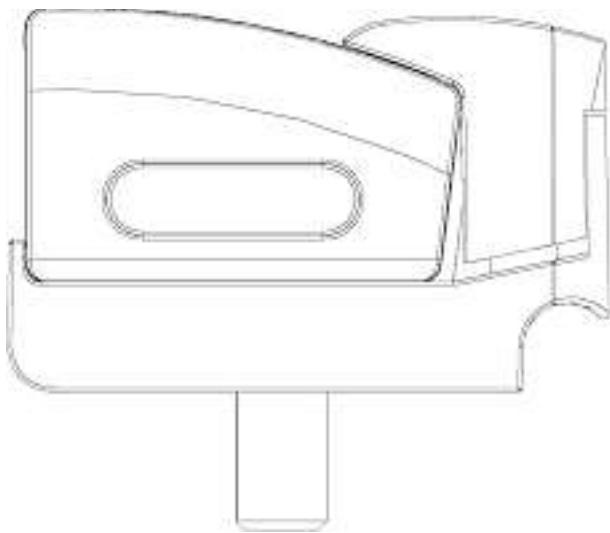

5



6

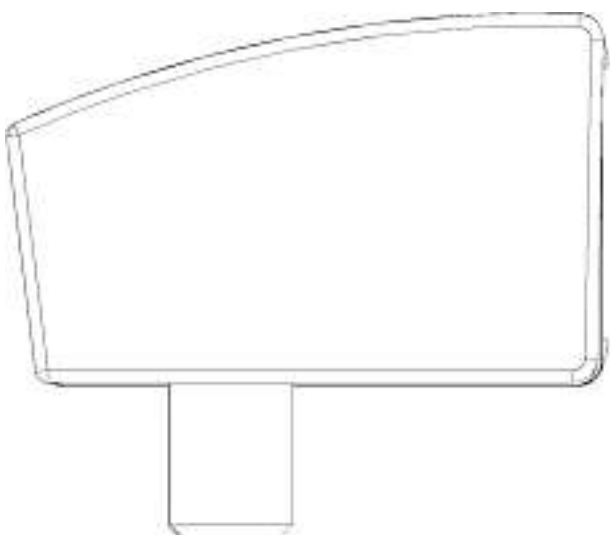

Cl. 10-07 **134 903** 04.03.2008
1 design – boîte de montre
Déposant: Nunzio Acierno, rue du Parc 93,
2300 La Chaux-de-Fonds



caisson Heidi Watch

Cl. 10-07 **134 904** 06.03.2008
 12 Design – Uhrarmbänder
 Hinterleger: Hirsch Armbänder GmbH, Hirschstrasse 5,
 Klagenfurt, AT
 Designer: Markus Kerker, Pörschach
 Vertreter: Hirsch (Schweiz) AG, 2500 Biel/Bienne



09 001



09 002



09 003



09 004

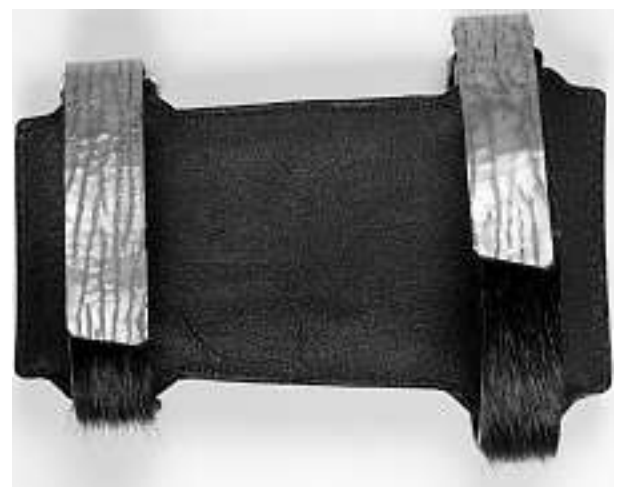
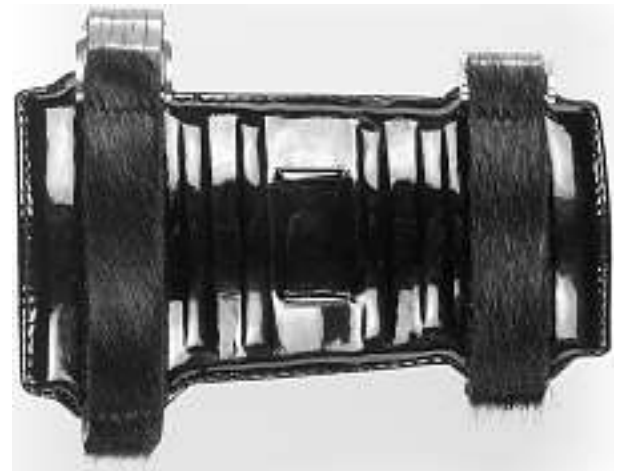

09 005





09 006



09 007

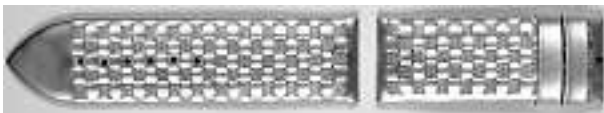

09 008



09 009



09 010



09 011



09 012

Cl. 10-07 **134 905** 12.03.2008

1 design – pont de cage supérieur
 Déposant: Badollet International SA, avenue d'Aire 40,
 1203 Genève
 Designer: Aldo Magada, Saint-Prex
 Mandataire: Inteltech SA, 2001 Neuchâtel

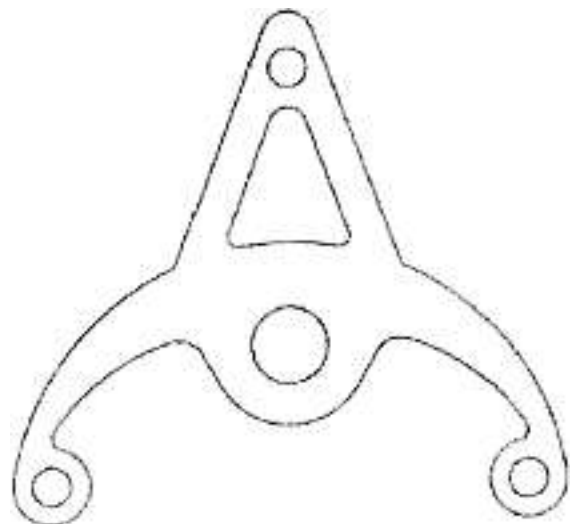
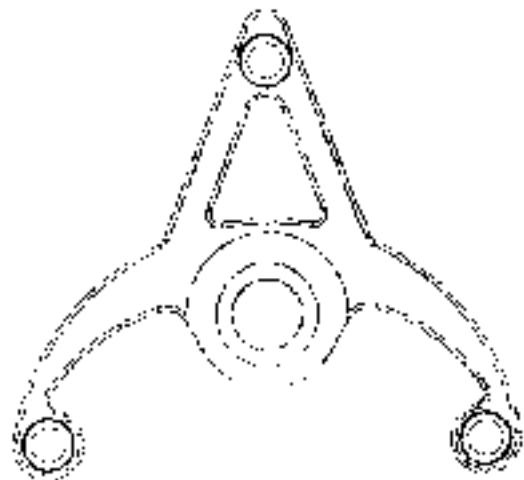

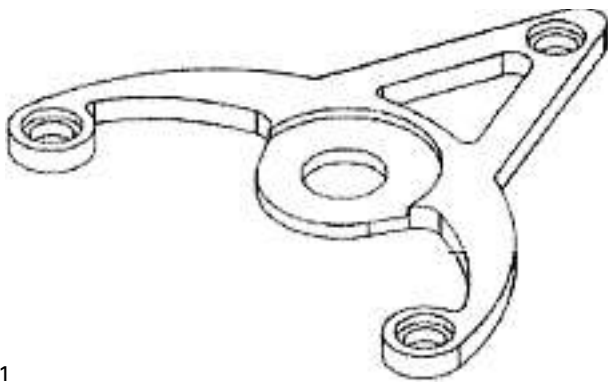

1

Cl. 10-07 134 906 17.03.2008
1 design – boîtier de montre
Déposant: New Heritage Limited, Room 1101, Hung Hom Commercial Centre, Tower B, 37 Ma Tao Wai Road, Kowloon, HK
Designer: Dai Hongbing, Gui Yang
Mandataire: Griffes Consulting S.A., 1206 Genève

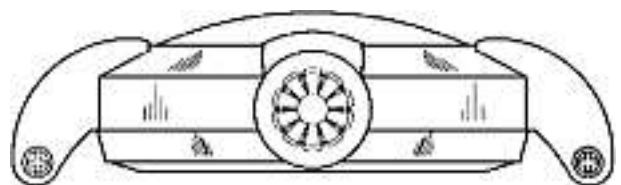
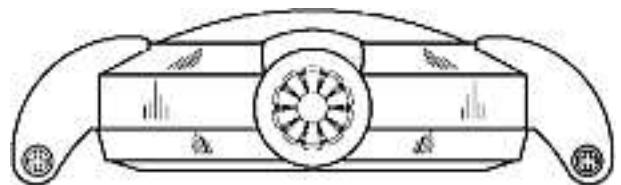
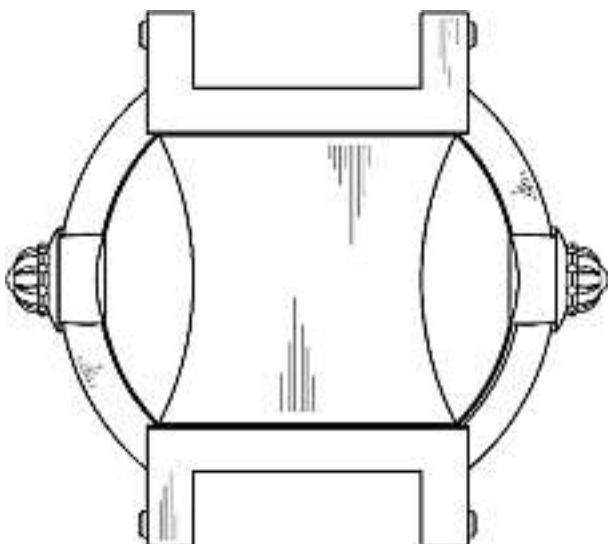
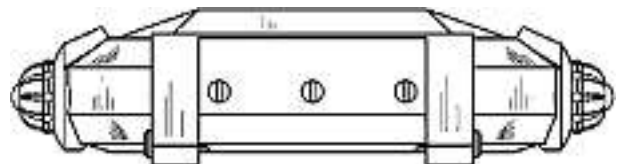
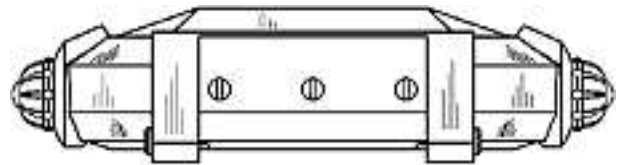
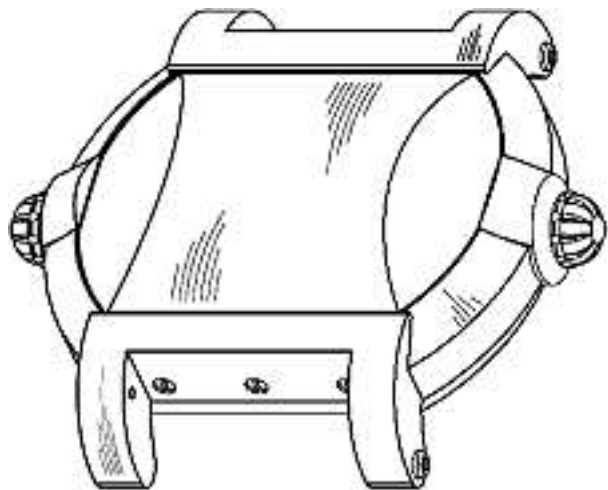
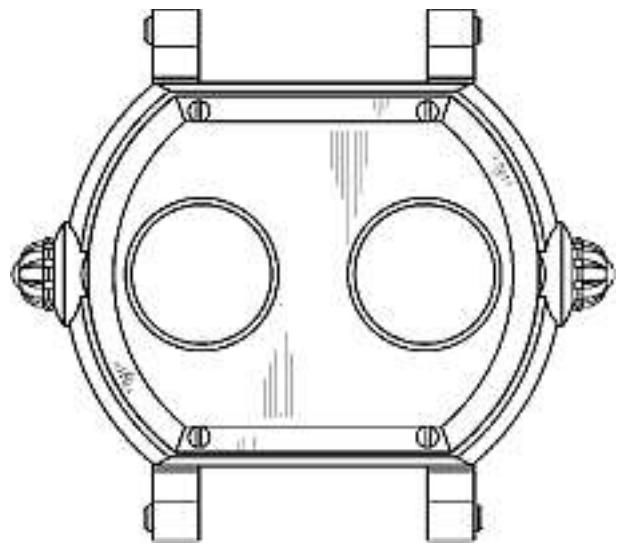

5997-MO-0021-CH-CH-01/sc

Cl. 10-07 134 907 20.03.2008
 1 design – montre
 Déposant: Bruno Paulino, rue de Lyon 14, 1201 Genève



montre avec jeu de Poker (Texas Hold'em)

Cl. 11-01 134 908 03.03.2008
 2 design – bijouterie
 Déposant: Jean Rufer, rue de la Dîme 58, 2000 Neuchâtel
 Mandataire: David Lambert, avocat, 2001 Neuchâtel

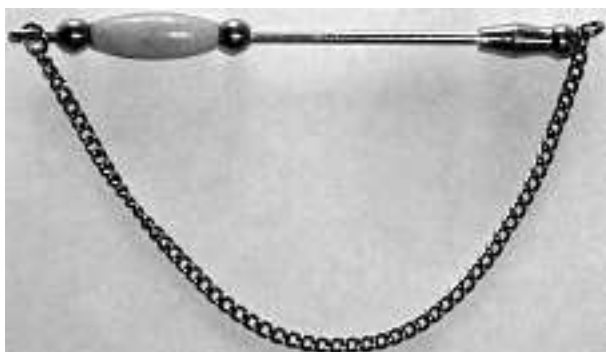

1730



38430704

Cl. 11-01 134 909 20.03.2008
 1 Design – Edelstein
 Hinterleger: LILI DIAMONDS, The Diamond Exchange -
 Maccabi Building, 1 Jabotinsky Street, 52520 Ramat Gan, IL
 Designer: Jacob Siman-Tov, Netanya; Itzhak Siman-Tov,
 Moshav Udim; Avraham Siman-Tov, Netanya
 Vertreter: Riederer Hasler & Partner Patentanwälte AG,
 7310 Bad Ragaz
 Priorität: IL, 02.12.2007

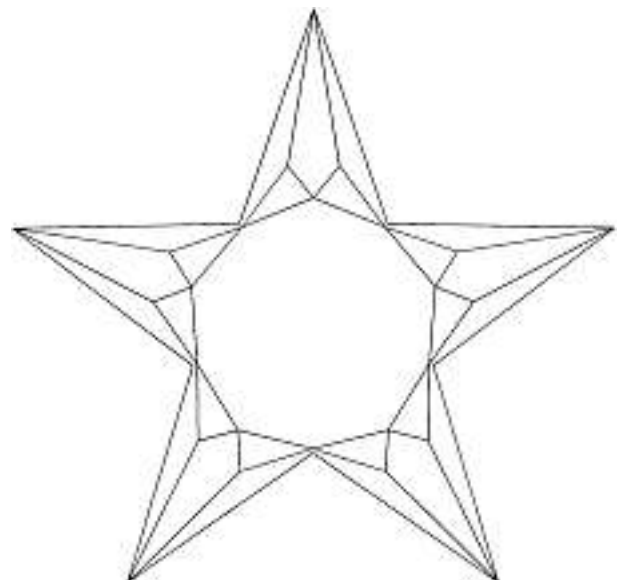
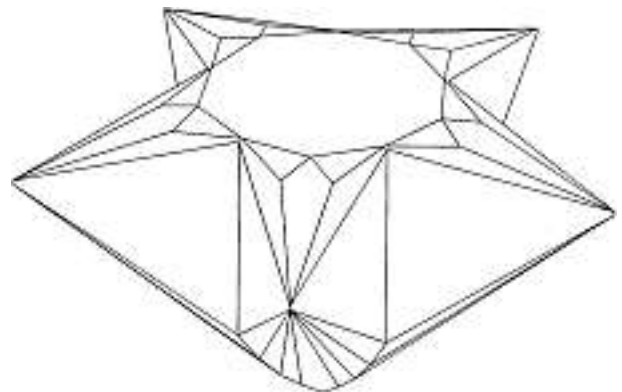

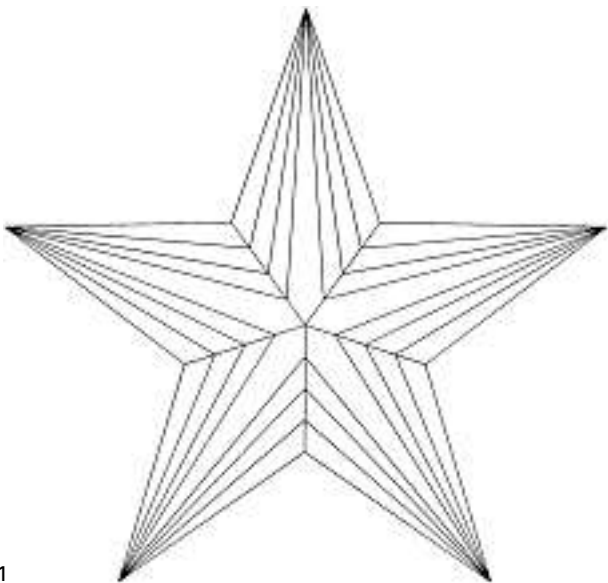
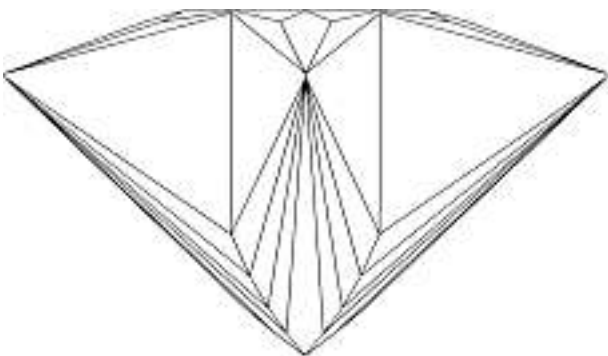
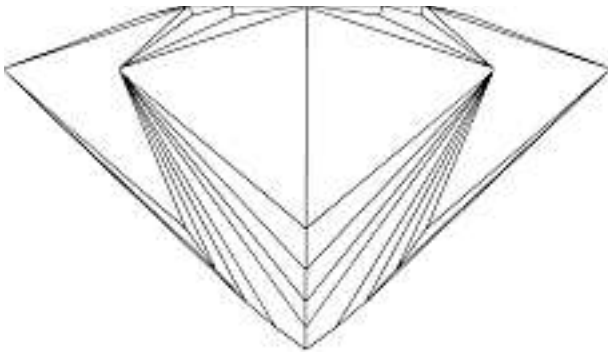

1

Cl. 11-02 **134 910** 25.02.2008
 1 Design – Dekorationsgegenstand
 Hinterleger: Romeo Csaba Kallos, Ringstrasse 4,
 4414 Füllinsdorf



1

Cl. 11-02 **134 911** 20.03.2008
 1 Design – Schale
 Hinterleger: Greutmann-Bolzern AG für Gestaltung,
 Sihlquai 268, 8005 Zürich
 Designer: Karin Claudia Panzer, München
 Beschreibung des Designs: Die Schale besteht aus einem
 Kabelbindergeflecht, welches aus ineinander-geschlaufen
 und miteinander verbundenen einzelnen Kabelbindern
 besteht, deren Enden nach aussen abstehen. Dieses Geflecht
 weist eine Steifigkeit auf, hält selbstständig und kann befüllt
 werden.

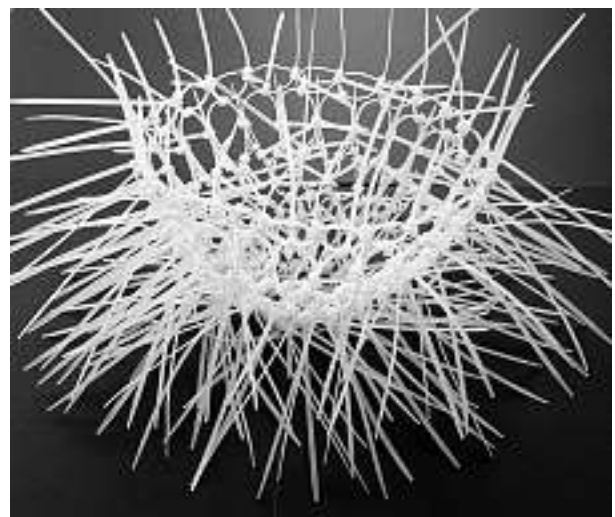
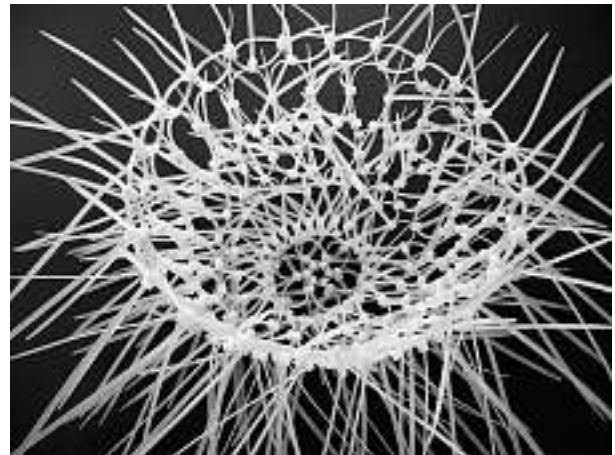

Kabelbinderschale 1

Cl. 12-08, 12-16 134 912 17.03.2008
 2 Design – Auto, Instrumentenhalterung
 Hinterleger: Honda Motor Co., Ltd., No. 1-1, 2-chome,
 Minami-aoyama, Minato-ku, Tokyo, JP
 Designer: Tetsuji Morikawa, Wako-shi; Yosuke Shimizu,
 Wako-shi
 Vertreter: E. Blum & Co. AG, Patent- und Markenanwälte VSP,
 8044 Zürich
 Priorität: JP, 21.09.2007; JP, 21.09.2007



1

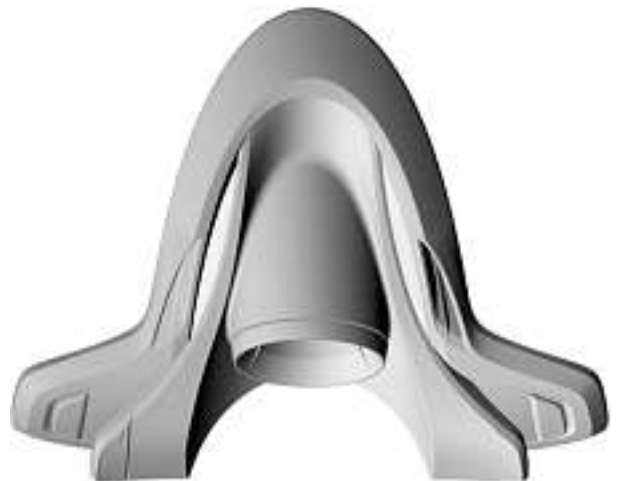

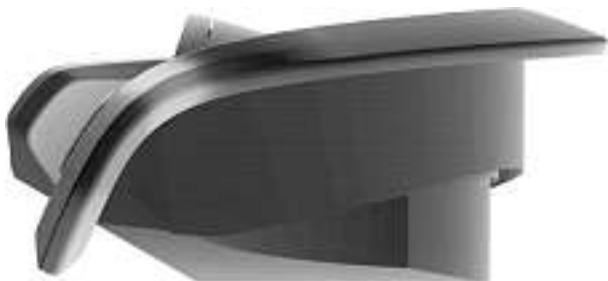

2

Cl. 12-16 **134 913** 10.03.2008
 1 design – guarnitura di strumenti indicatori per autoveicolo
 Depositante: Honda Motor Co., Ltd., No. 1-1, 2-chome,
 Minami-aoyama, Minato-ku, Tokyo, JP
 Designer: Takuya Okita, Saitama-ken
 Mandatario: Fiammenghi-Fiammenghi, 6900 Lugano
 Priorità: JP, 21.09.2007





514

Cl. 12-16 **134 914** 20.03.2008
1 Design – Sonnenabdeckung
Hinterleger: Santiago Calatrava Valls, Parkring 11,
8002 Zürich
Vertreter: Luchs & Partner, Patentanwälte, 8002 Zürich

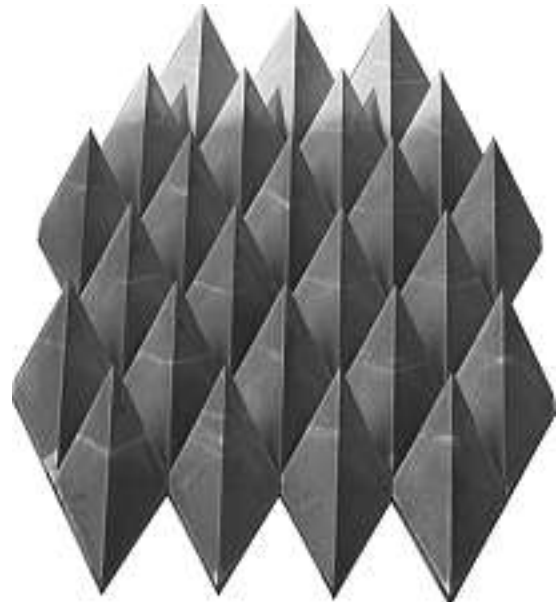



Cl. 13-03 **134 915** 18.03.2008
 1 design – adaptateur de tension
 Déposant: Combotronic Limited, Flat A, 10th Floor, Hop Lung Factory Building, 1 Mong Lung Street, Shauiwan, Hong Kong, HK
 Designer: Kam Wah So, Hong Kong
 Mandataire: Bugnion S.A., 1211 Genève 12 - Champel
 Priorité: HK, 28.09.2007

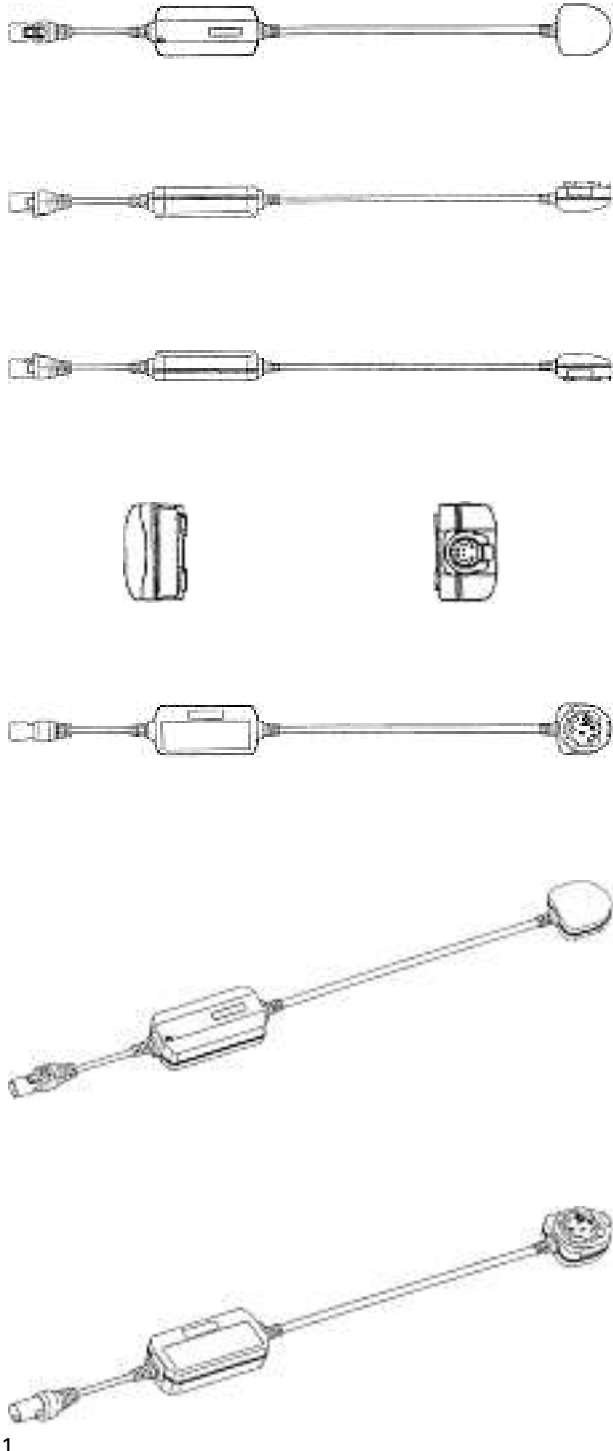

1

Cl. 14-99 **134 916** 25.03.2008
 1 Design – Gerätehalterung
 Hinterleger: designtrade gmbh the innovative company, Scheyenholzstrasse 55, 3075 Rüfenacht BE
 Designer: Rolf Widmer, Rüfenacht



ELT001

Cl. 16-03 **134 917** 07.03.2008
 2 Design – Tonerkassette
 Hinterleger: Toshiba Tec Kabushiki Kaisha, 2-17-2, Higashigotanda, Shinagawa-ku, Tokyo 141-8664, JP
 Designer: Yoshiaki Tanaka, Mishima-Shi
 Vertreter: E. Blum & Co. AG, Patent- und Markenanwälte VSP, 8044 Zürich
 Priorität: JP, 14.09.2007; JP, 14.09.2007

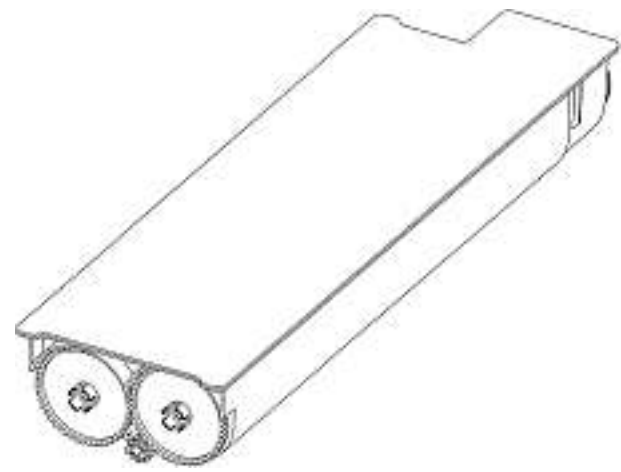

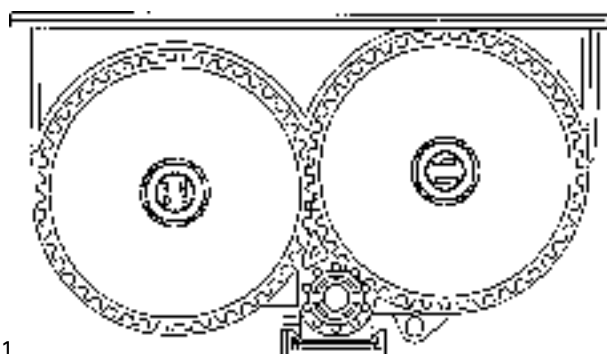
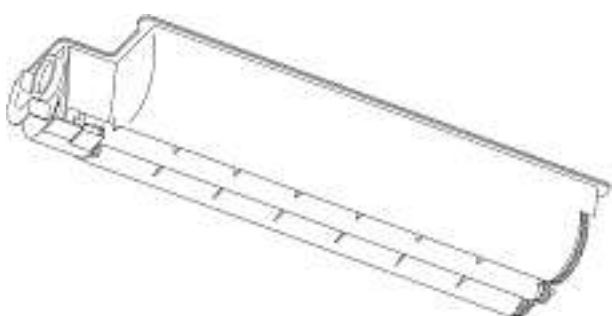
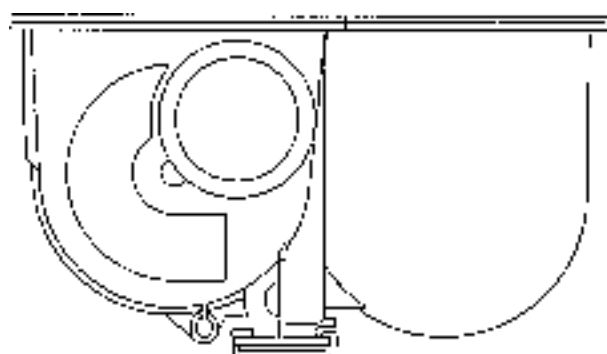
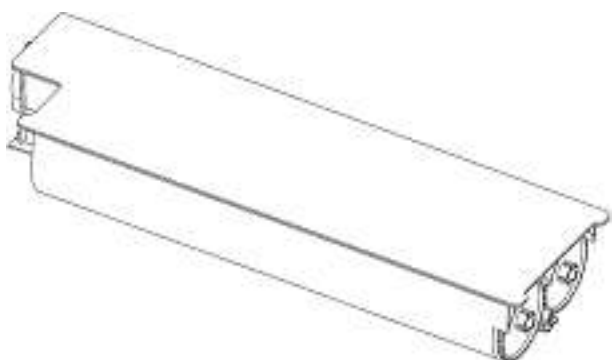
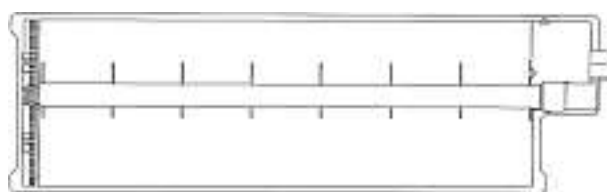
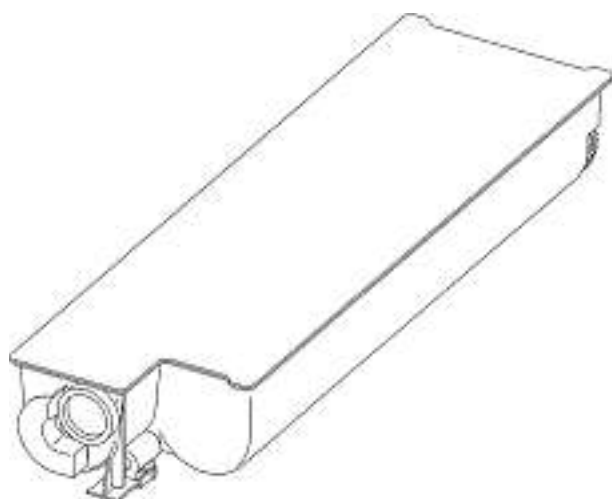

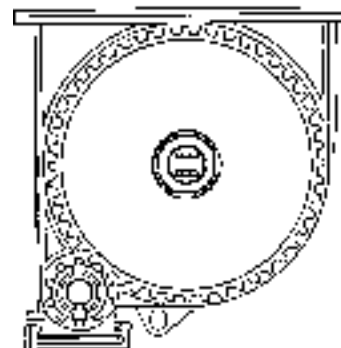
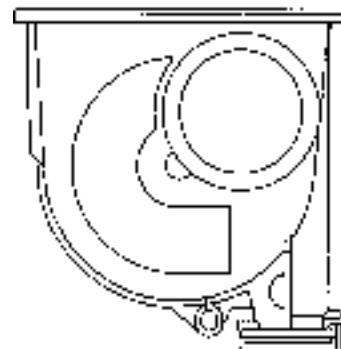
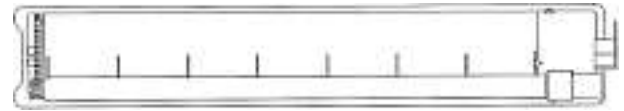
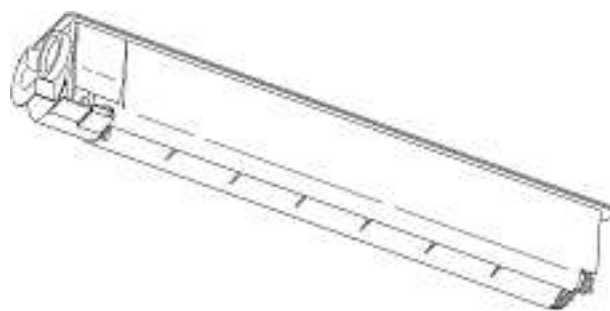
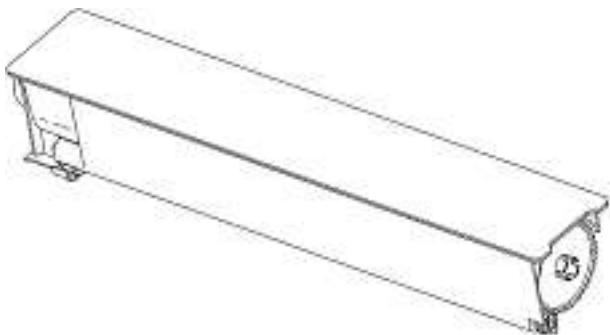
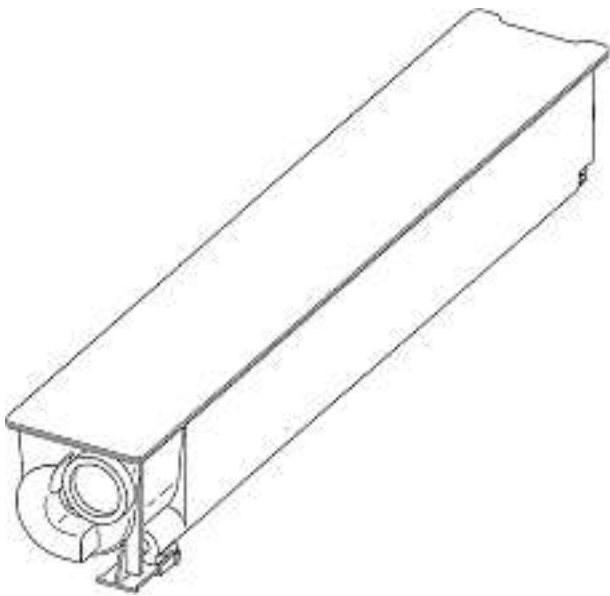
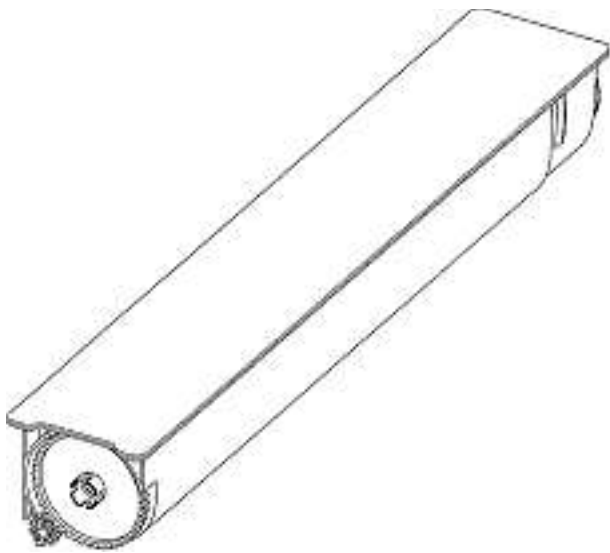

2

Cl. 19-04 134 918 07.03.2008
5 Design – Notizbuch
Hinterleger: Prodir S.A., 6814 Cadempino
Designer: Christoph Schnug, Milano
Vertreter: Baker & McKenzie, 8034 Zürich

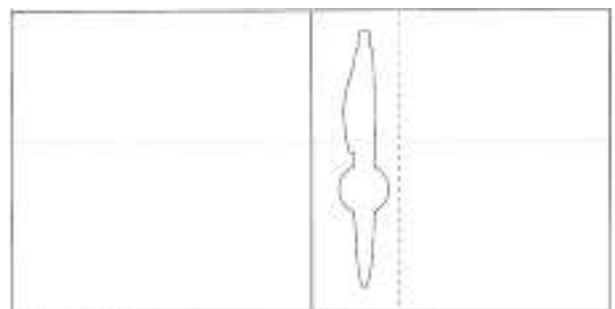

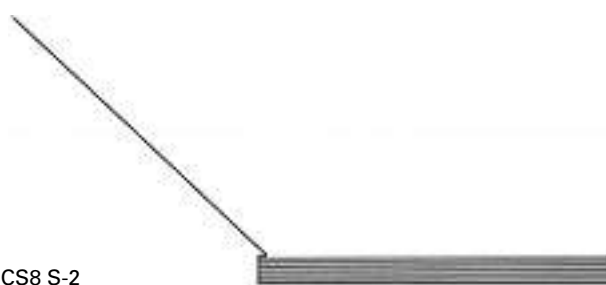
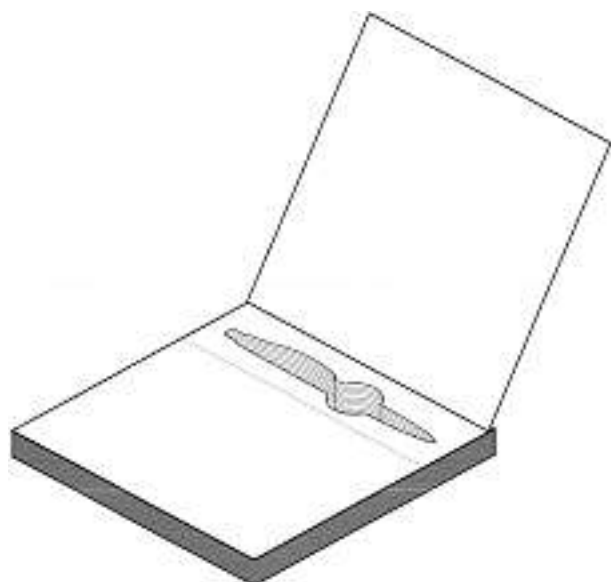
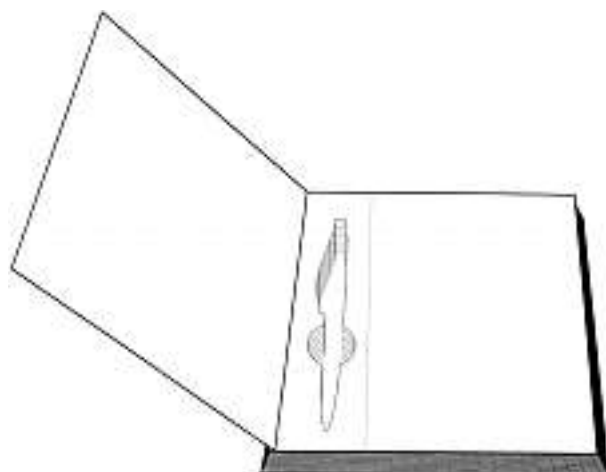
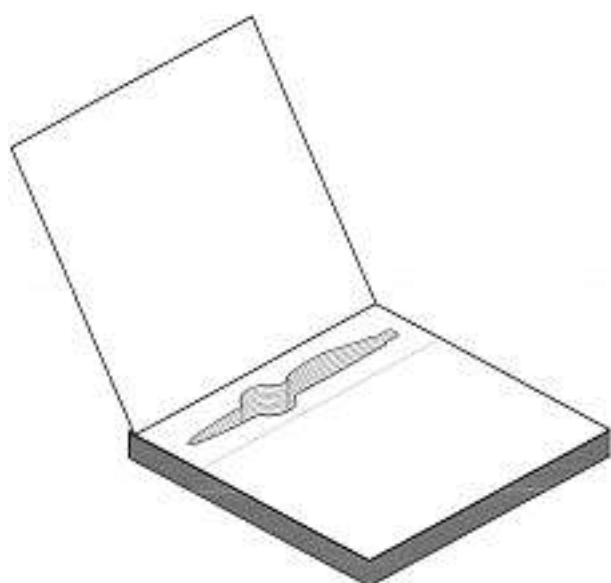
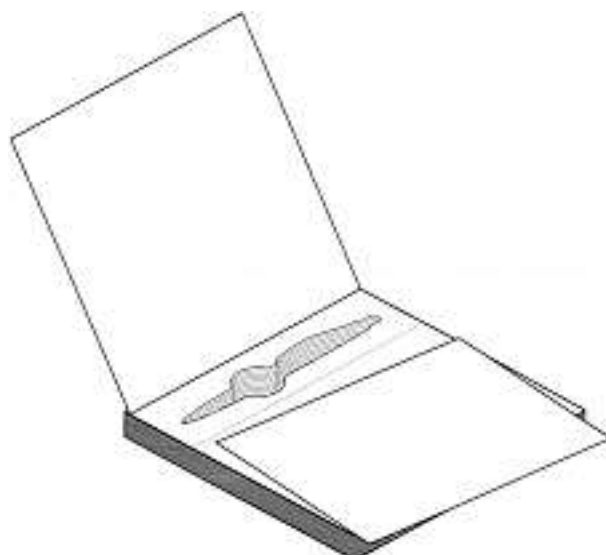
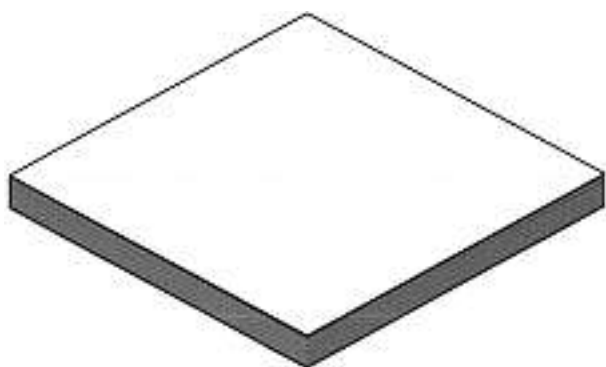

CS8 S-2

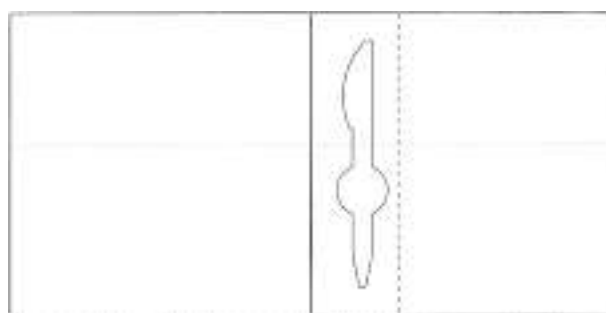

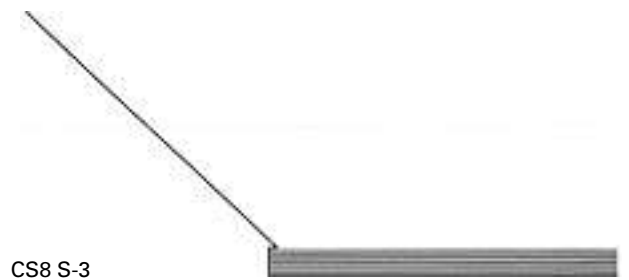
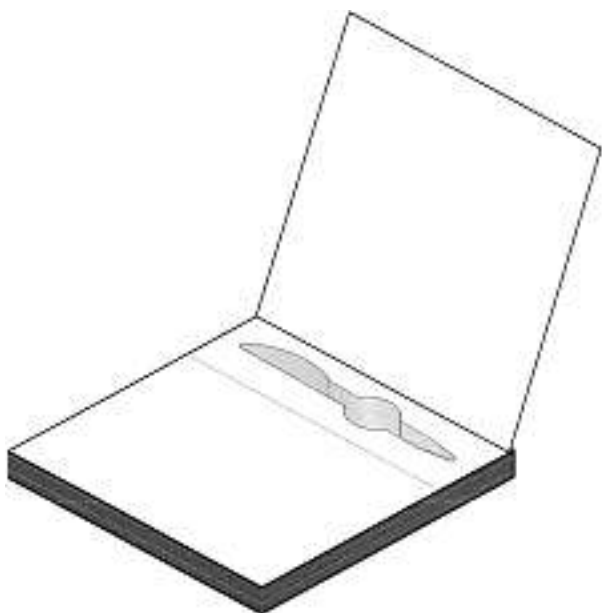
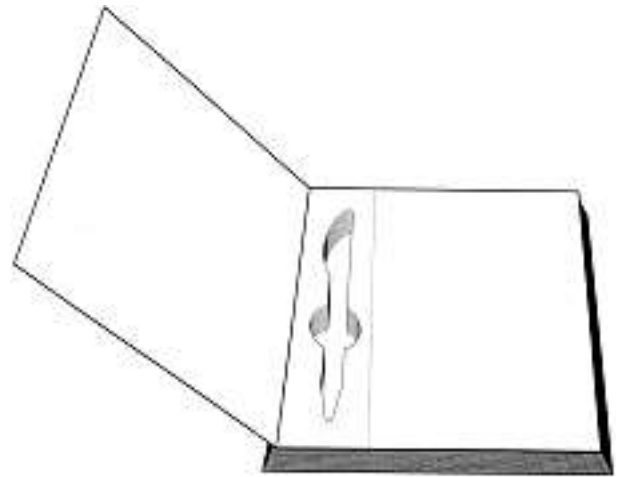
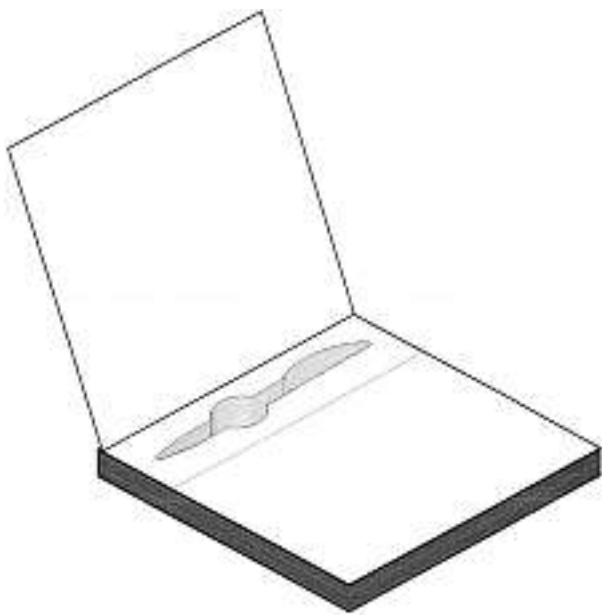
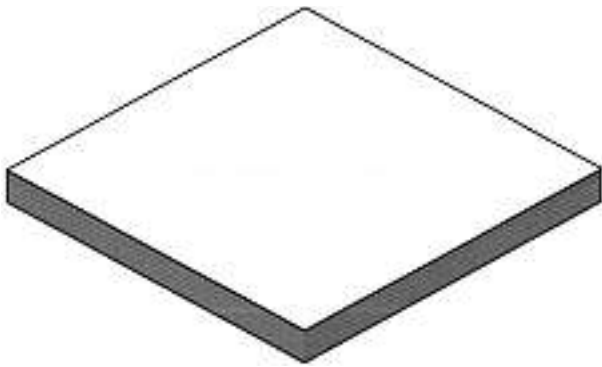

CS8 S-3

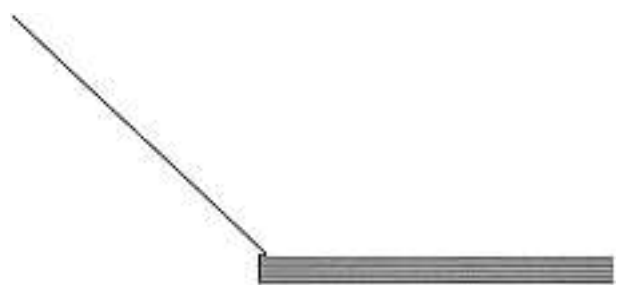

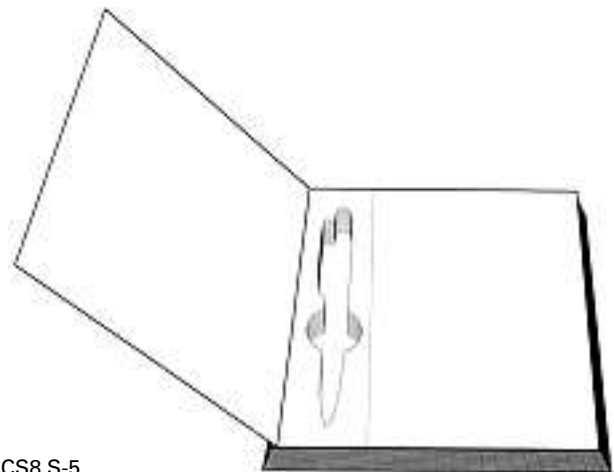
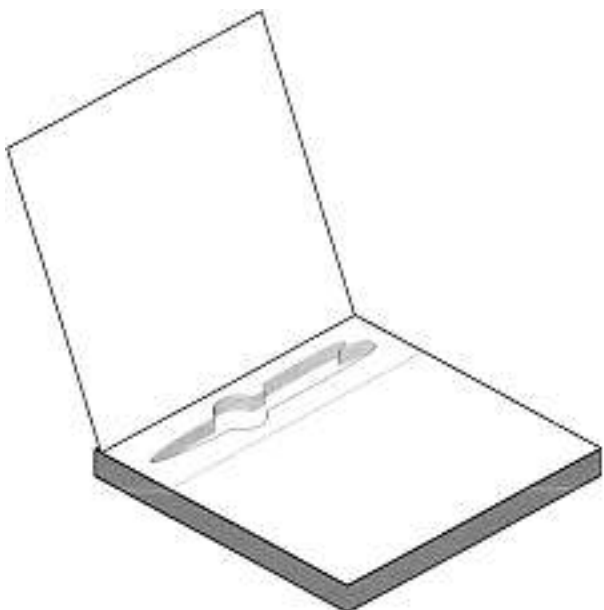
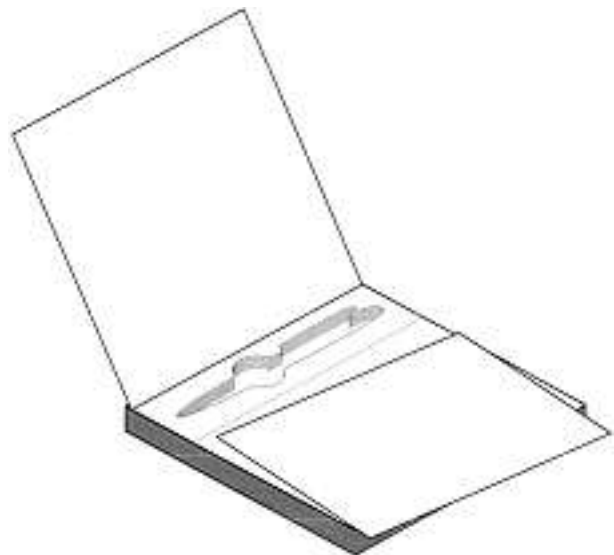
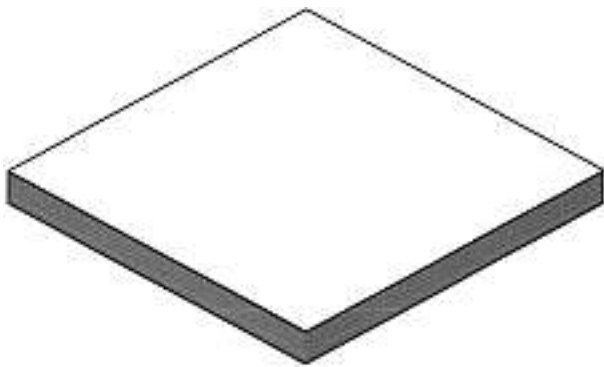
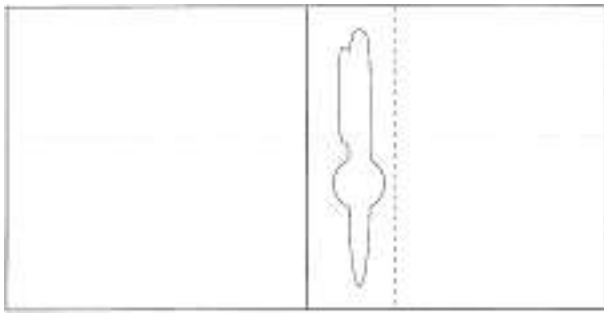

CS8 S-5

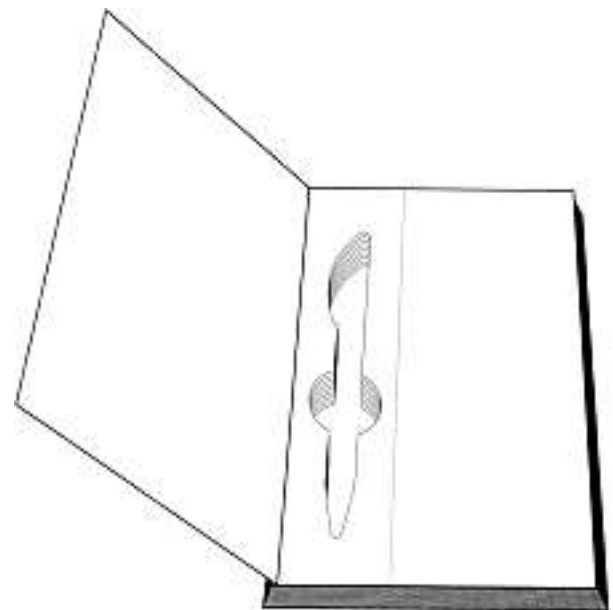
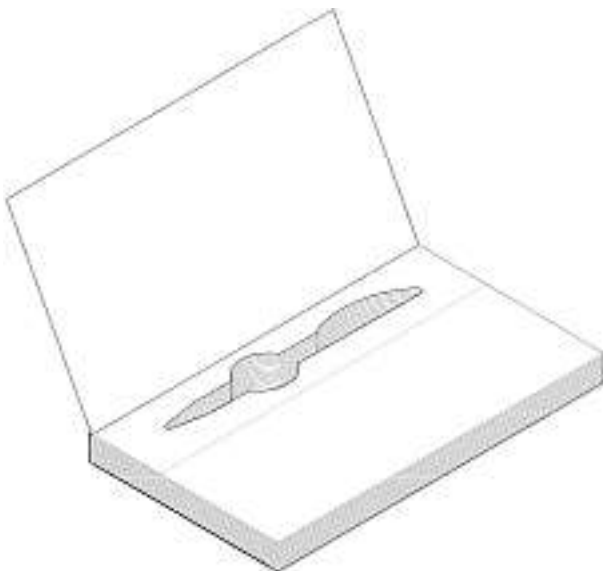
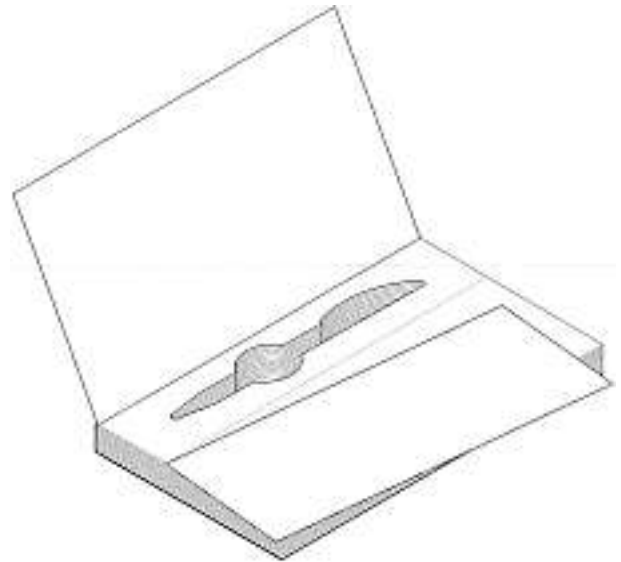
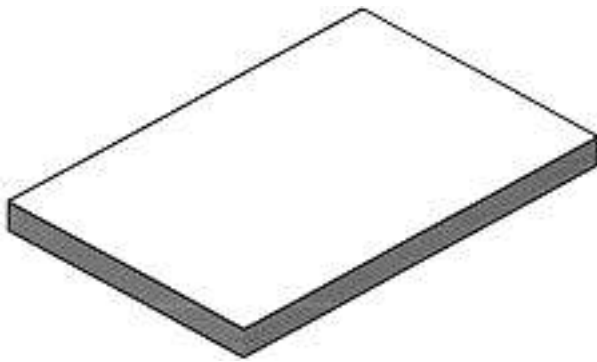
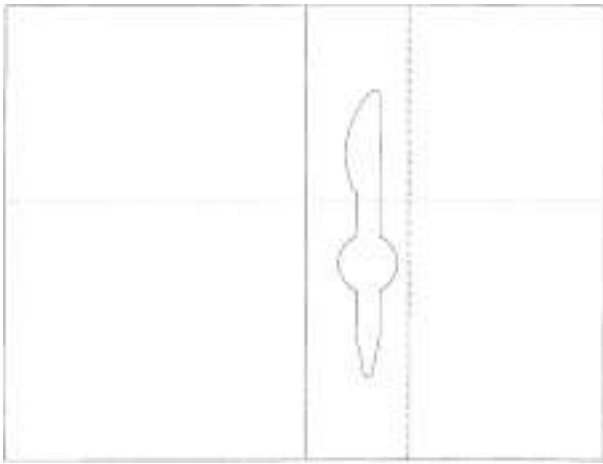

CS8 M-3

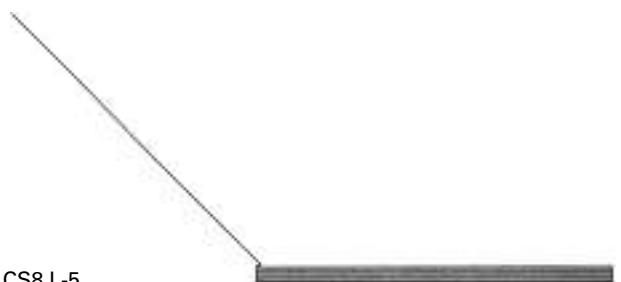
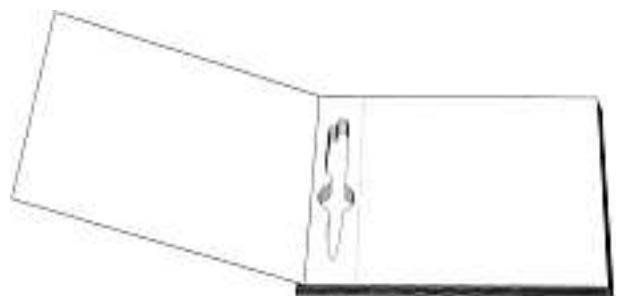
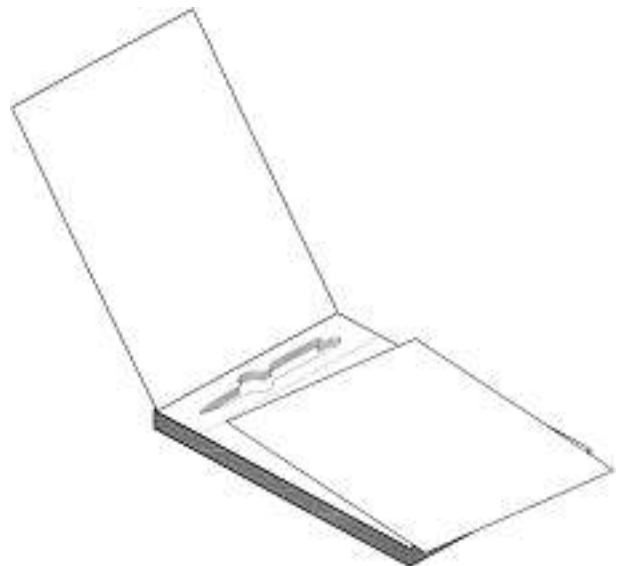
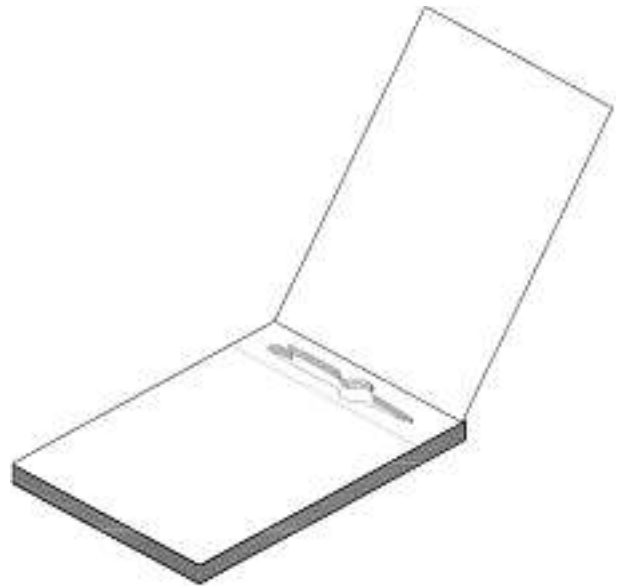
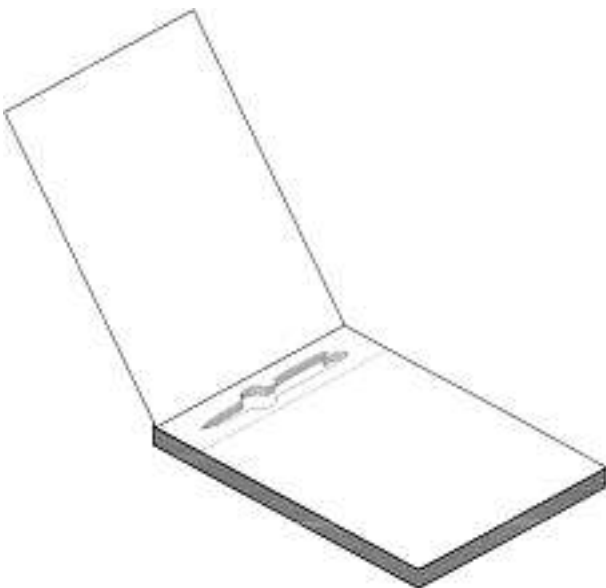
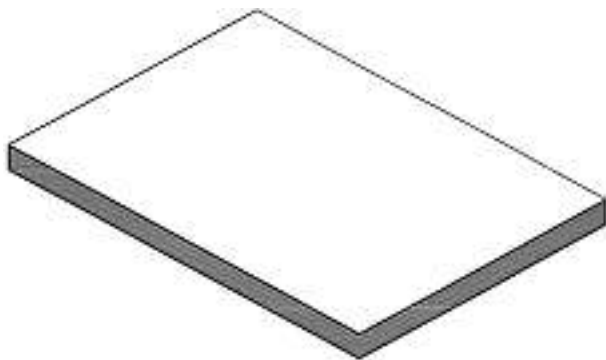
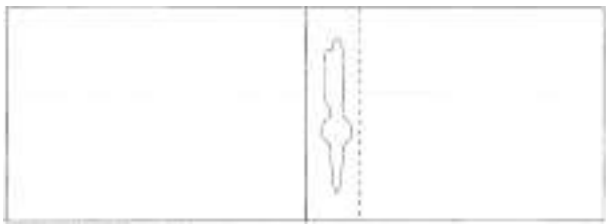
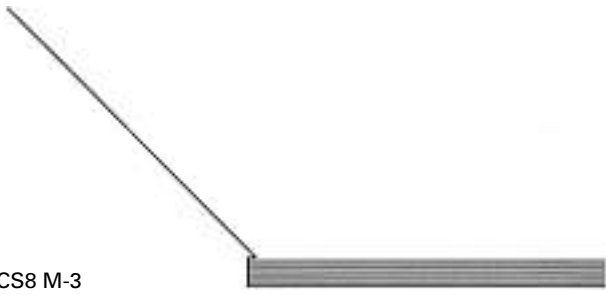

CS8 L-5

Cl. 19-04 134 919 10.03.2008
9 Design – Notizbuch
Hinterleger: Prodir S.A., 6814 Cadempino
Designer: Christoph Schnug, Milano
Vertreter: Baker & McKenzie, 8034 Zürich

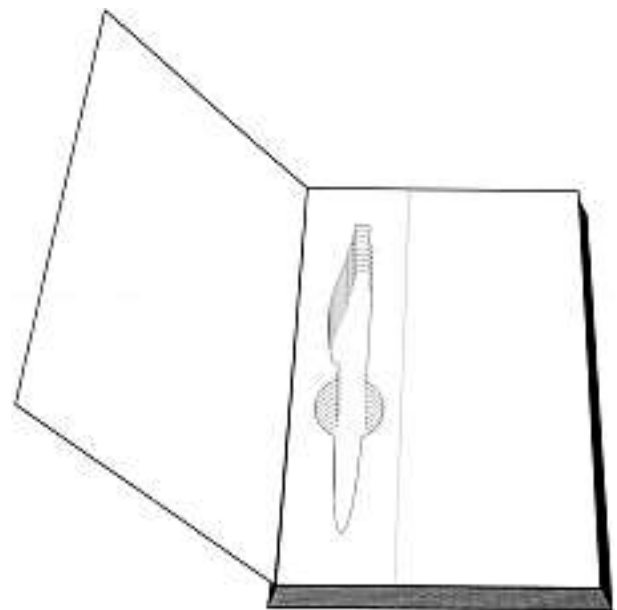
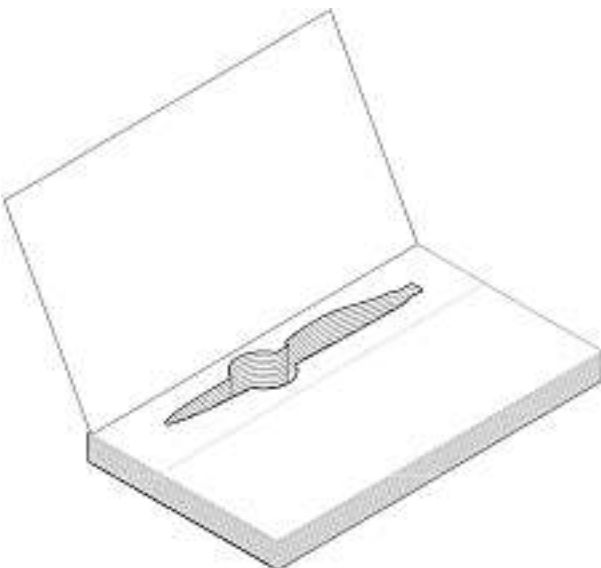
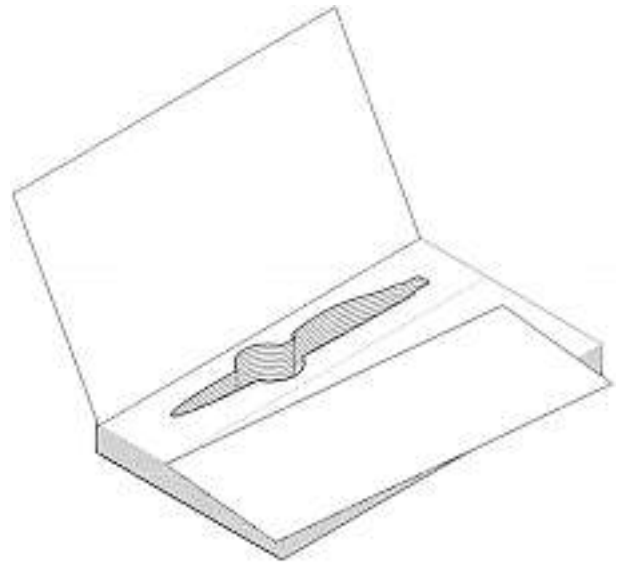
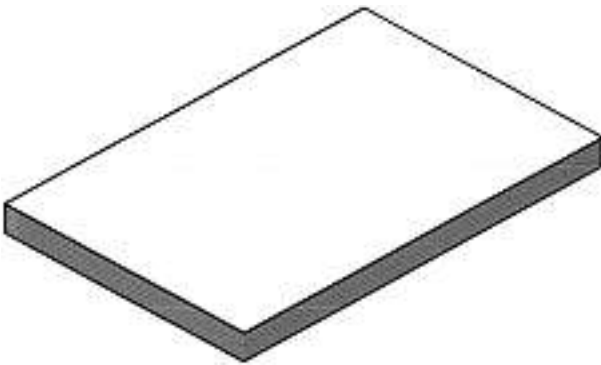
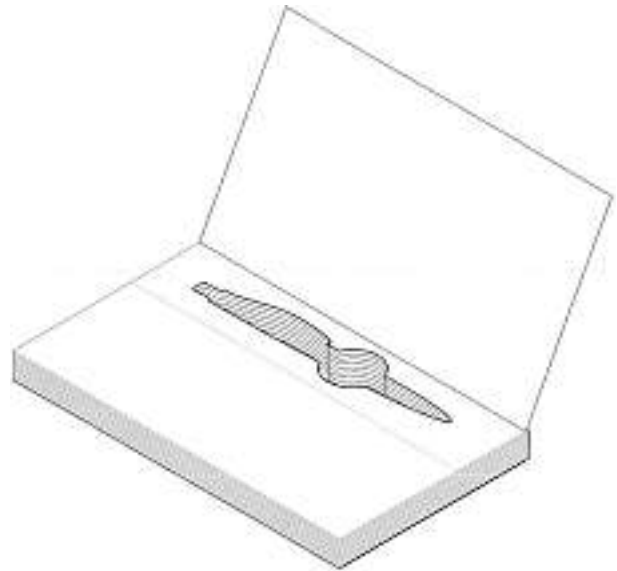
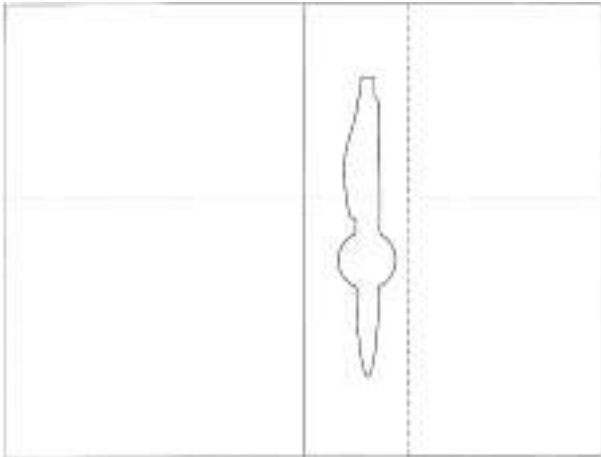

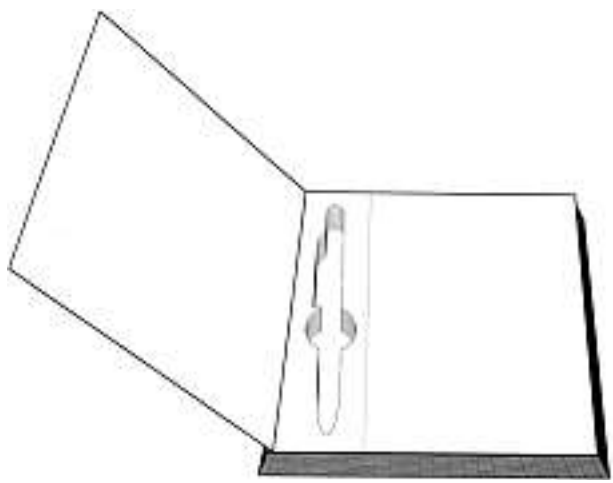
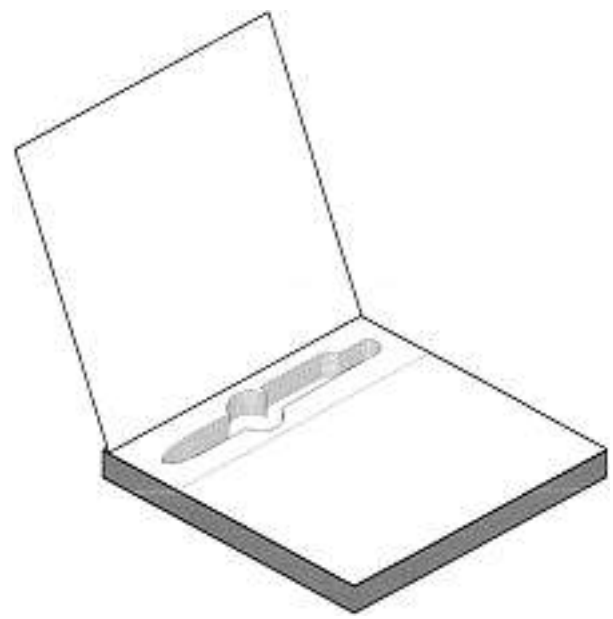
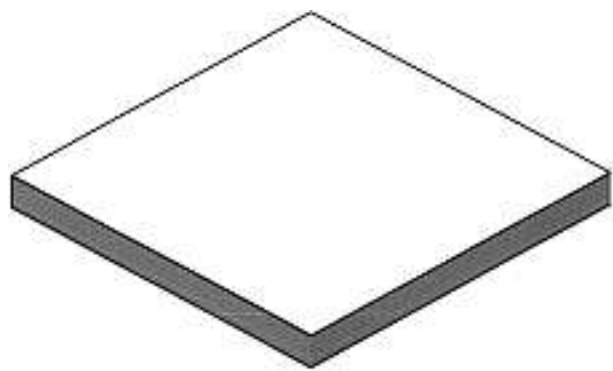
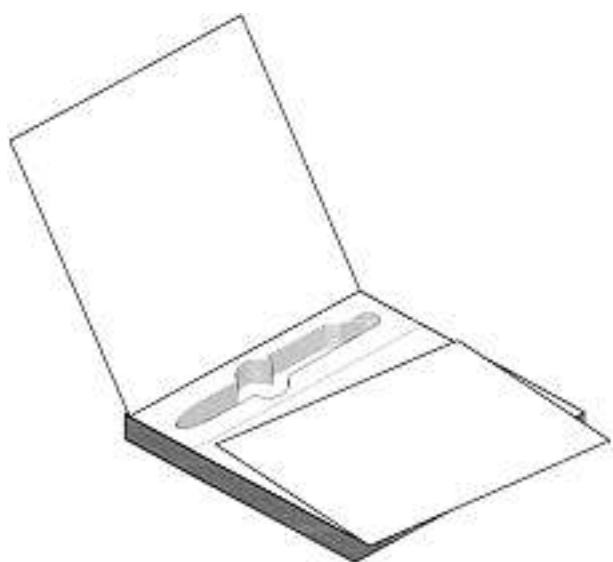
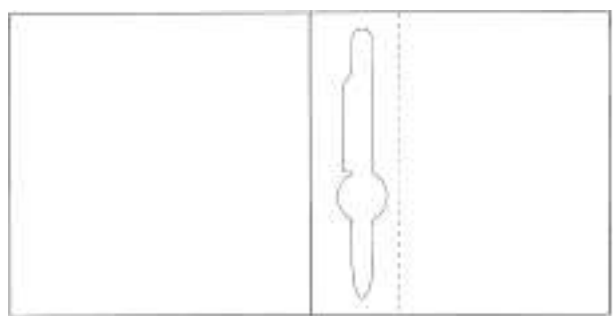
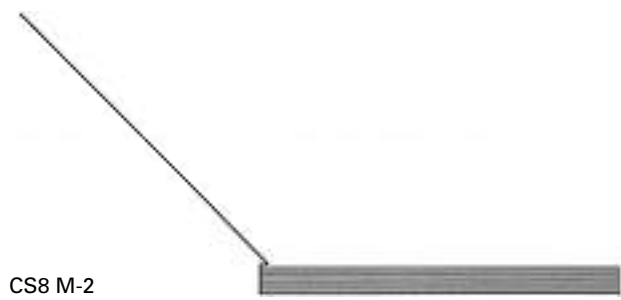

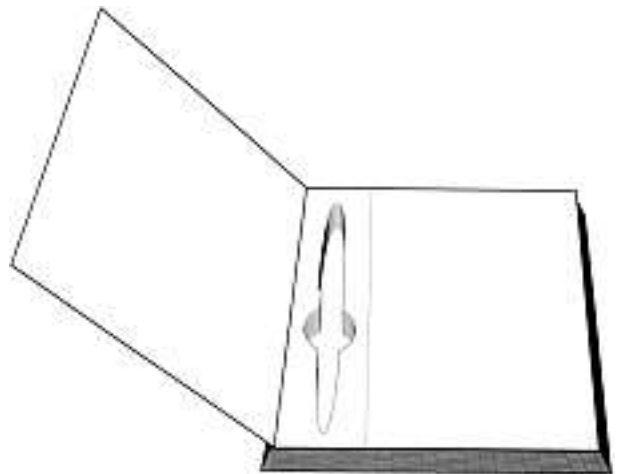
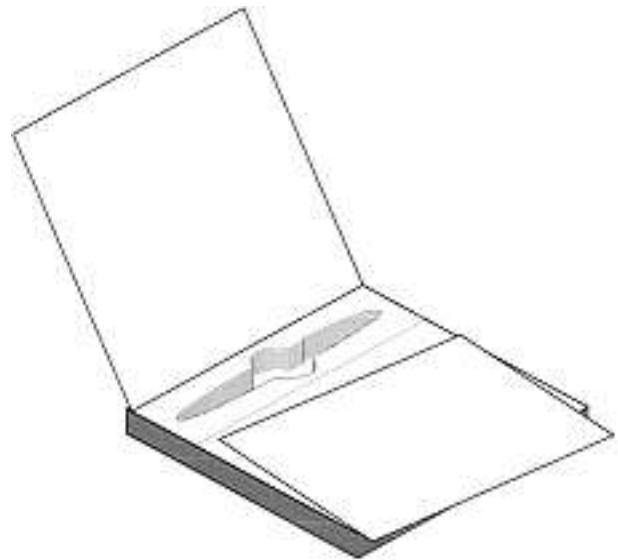
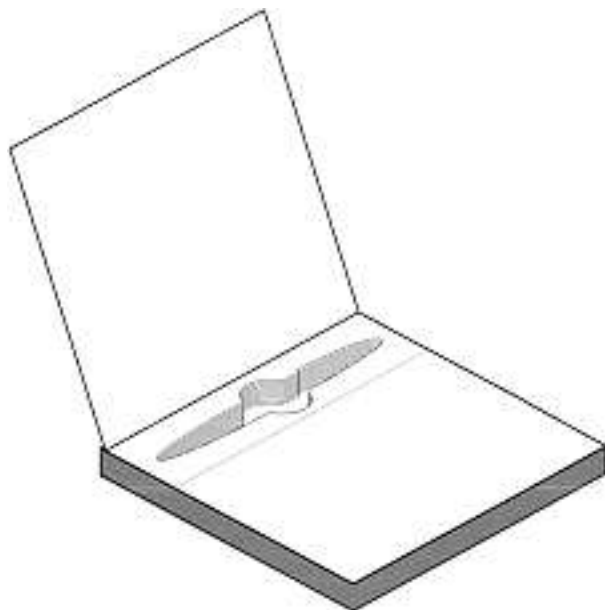
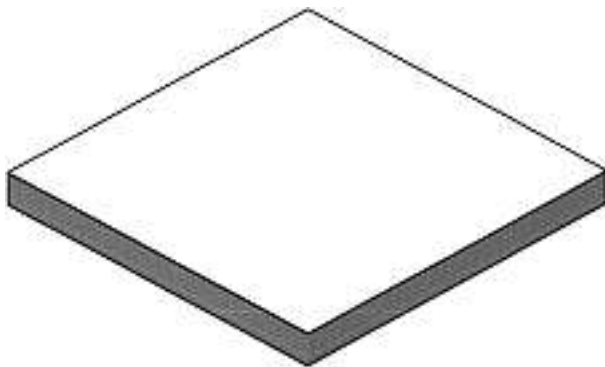
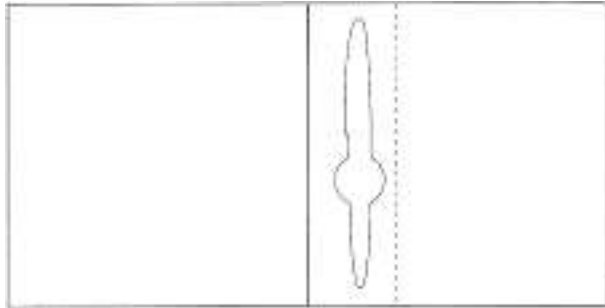
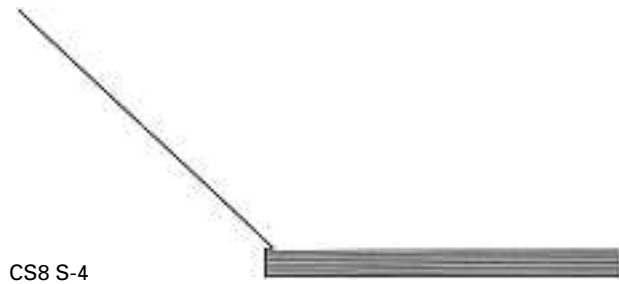

CS8 S-7

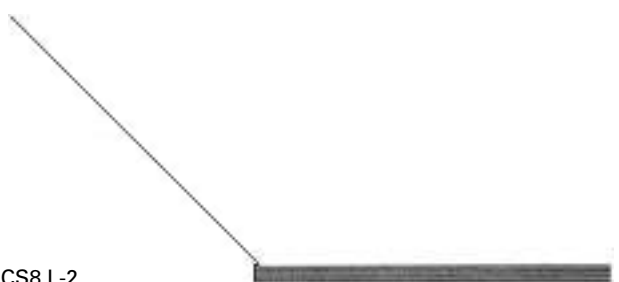
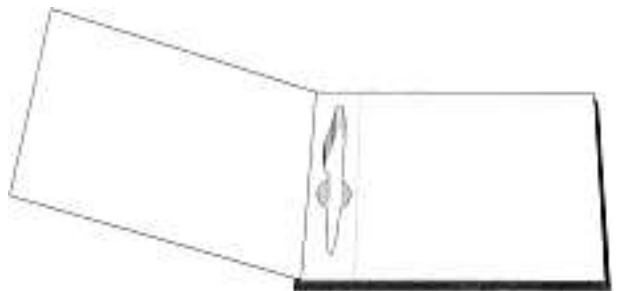
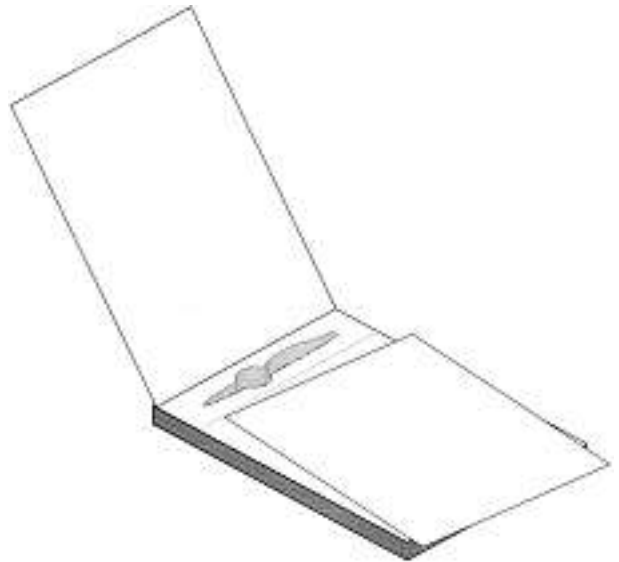
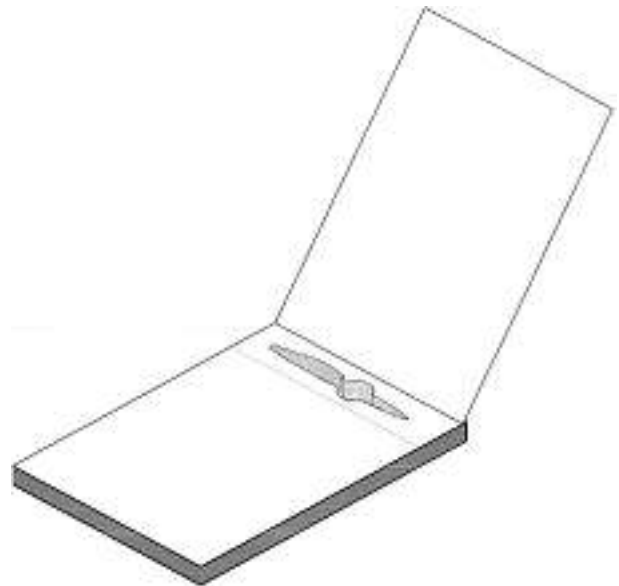
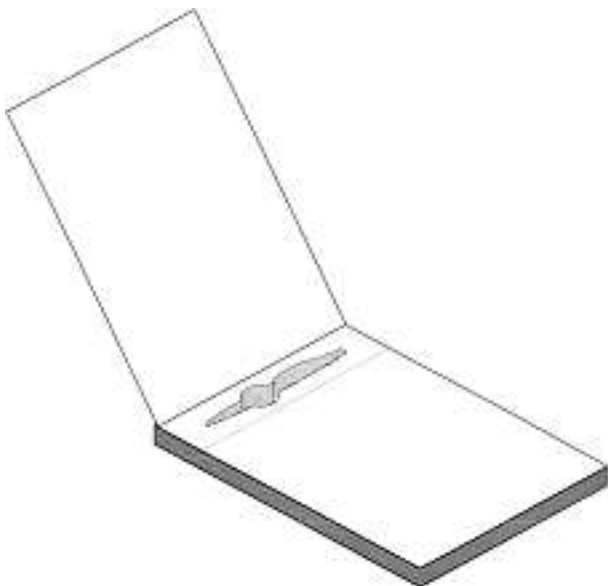
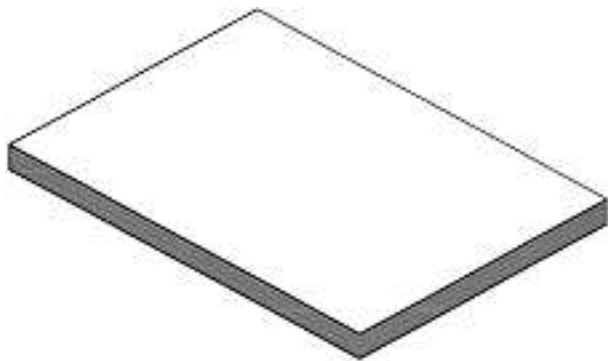
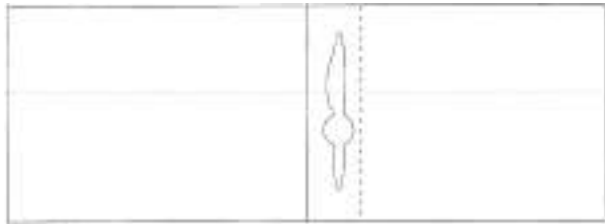
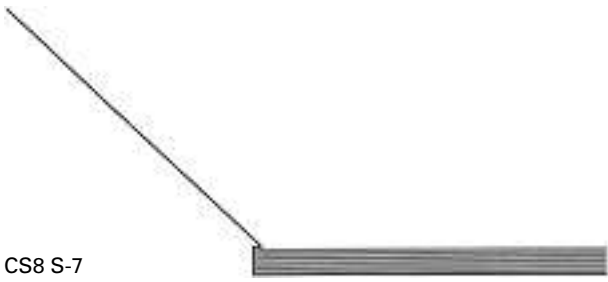

CS8 L-2

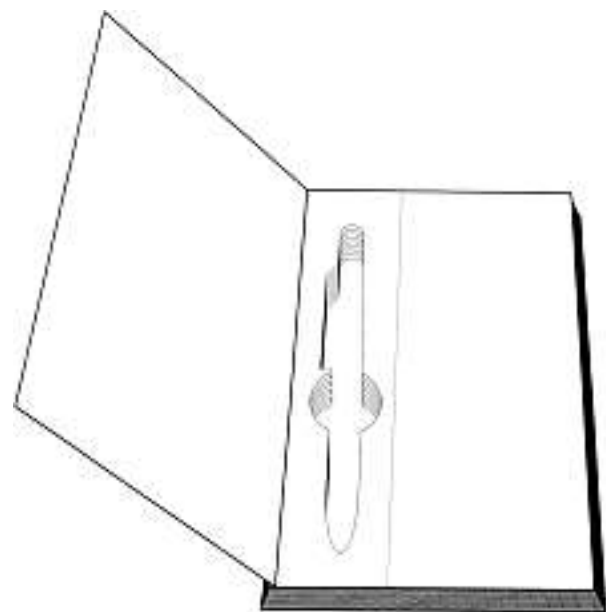
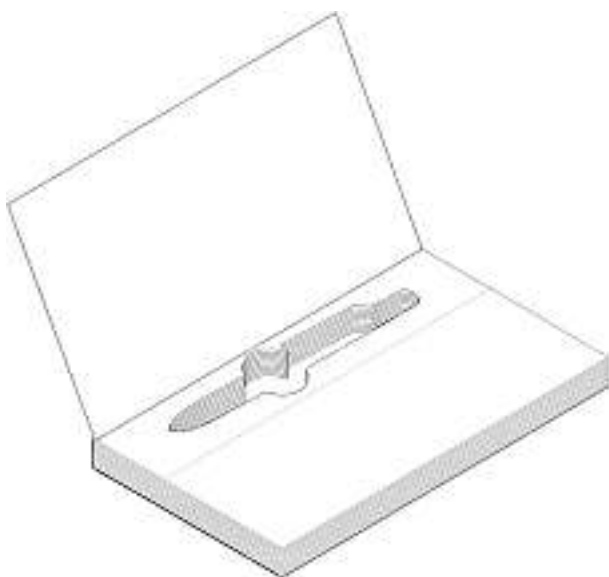
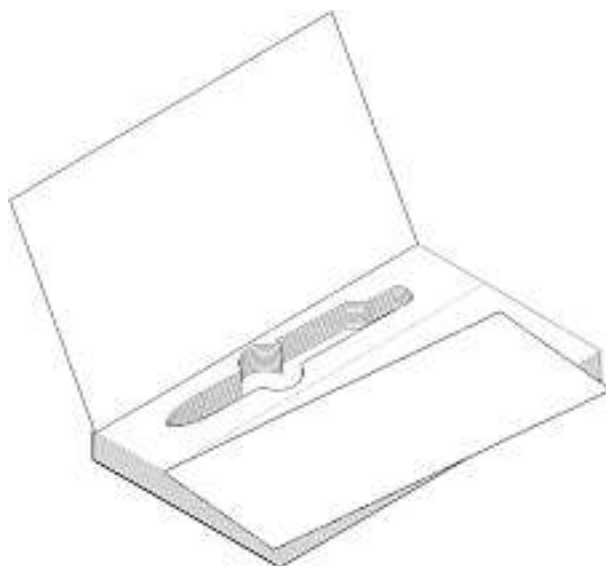
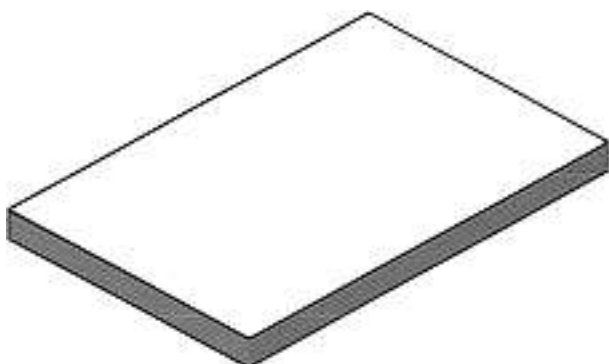
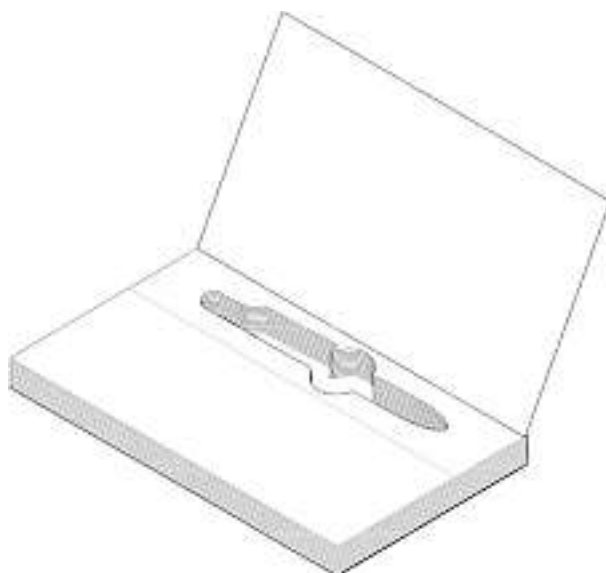
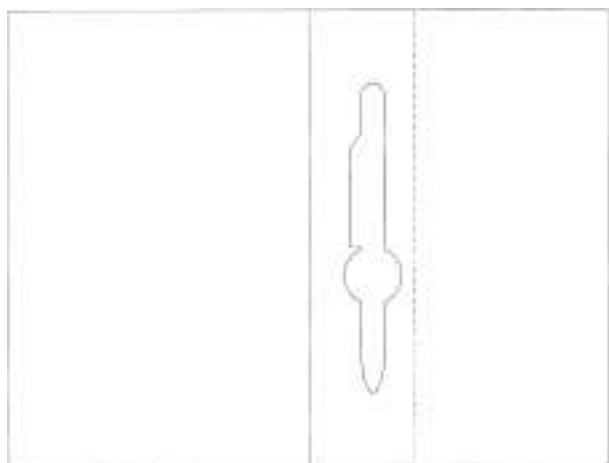

CS8 M-4

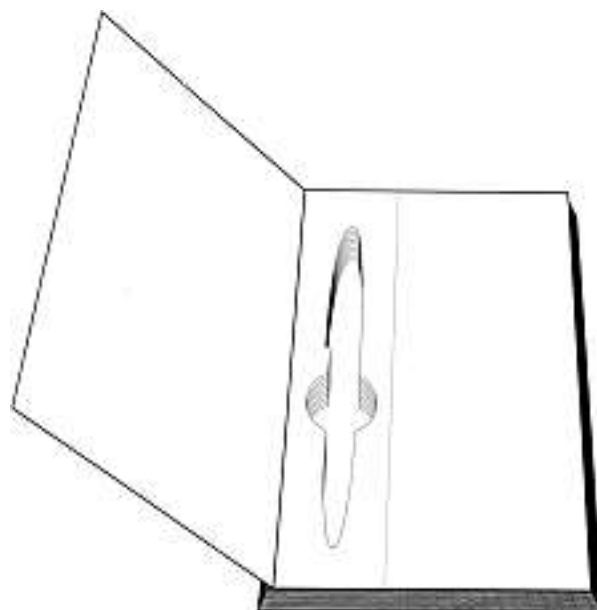
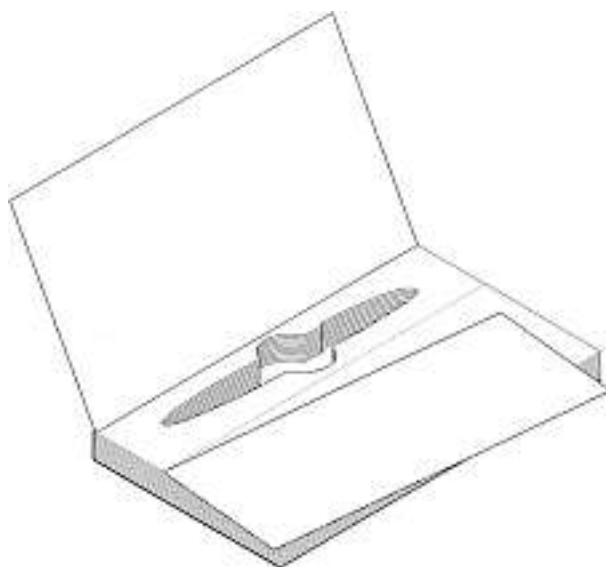
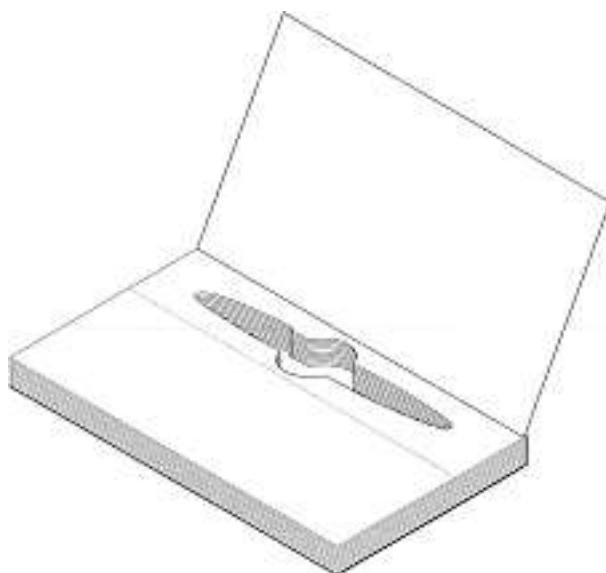
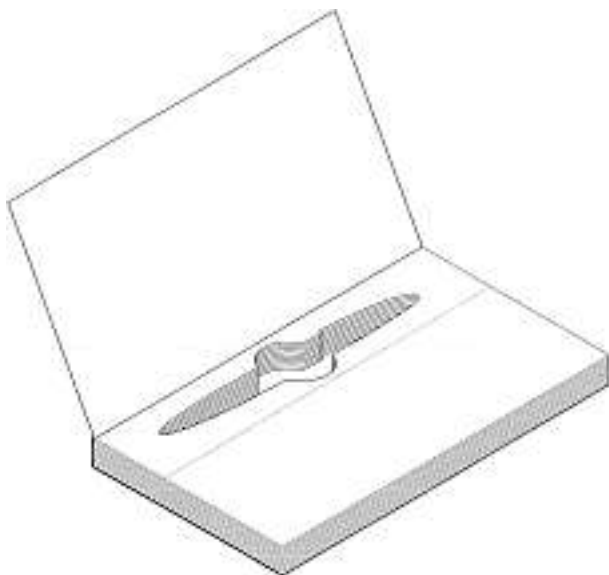
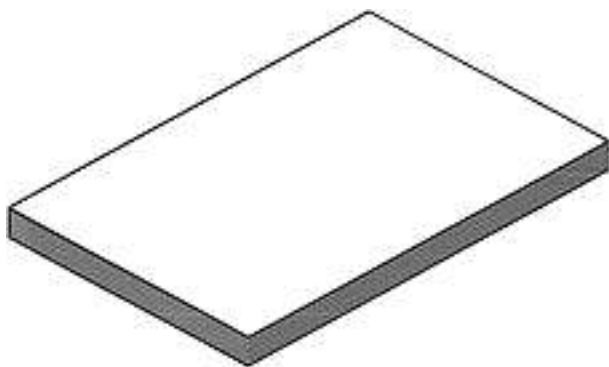
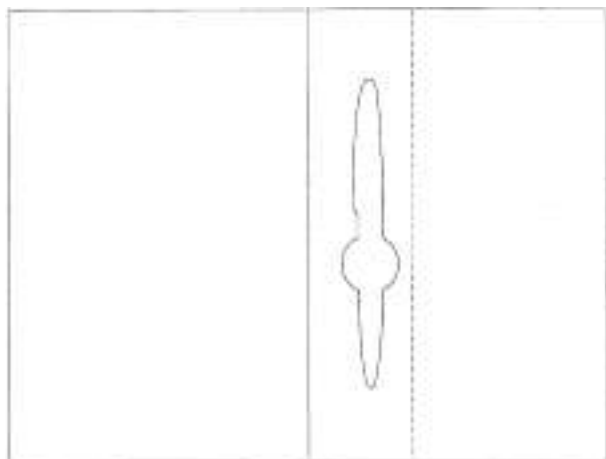
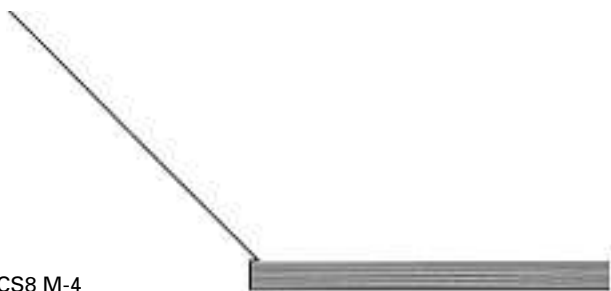

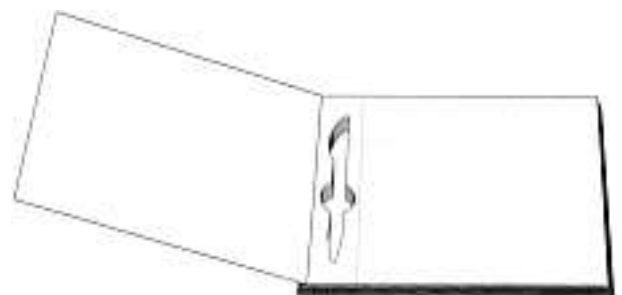
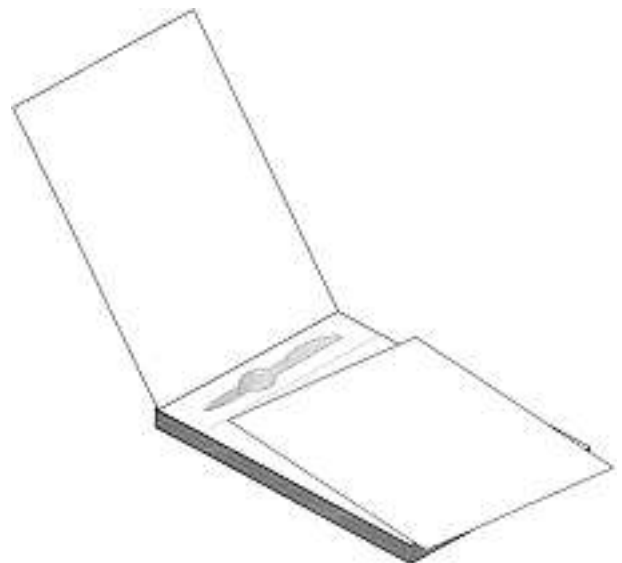
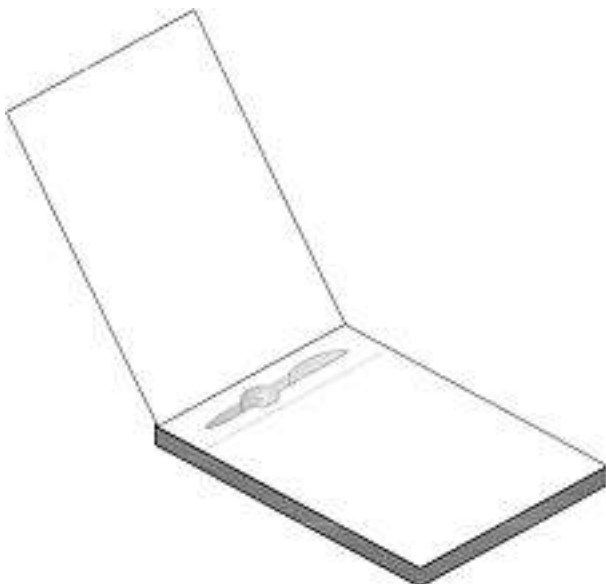
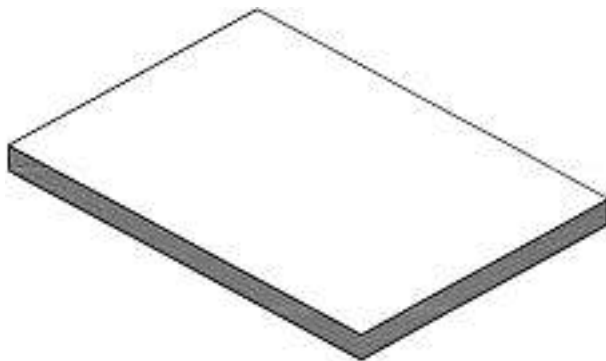
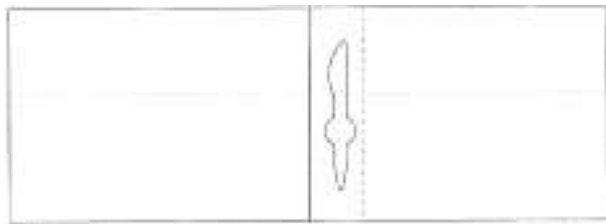
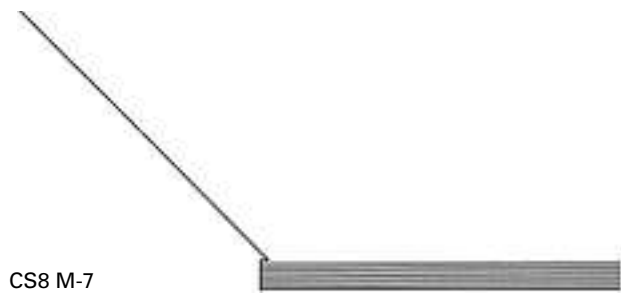

CS8 L-3

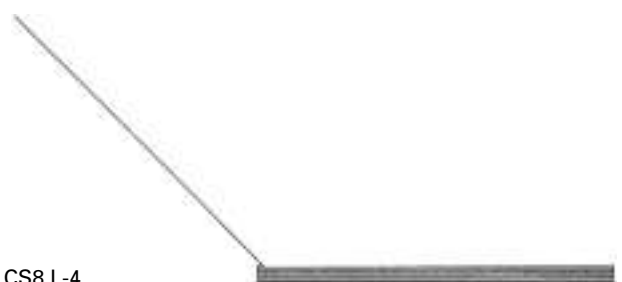
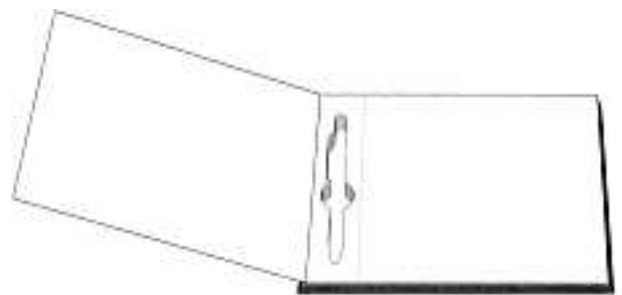
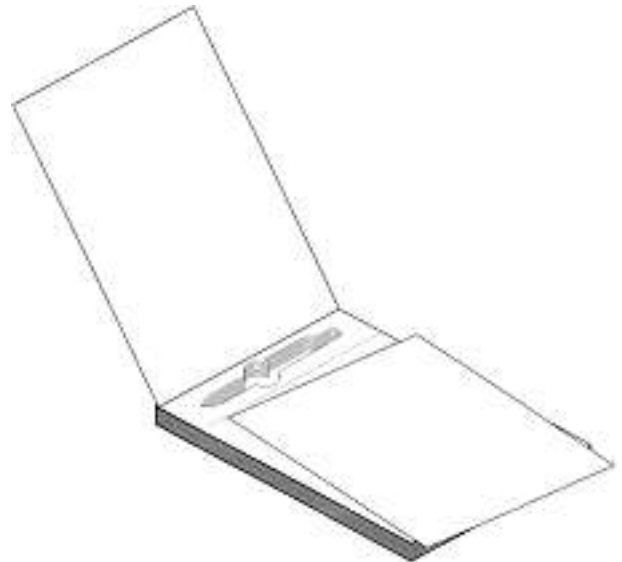
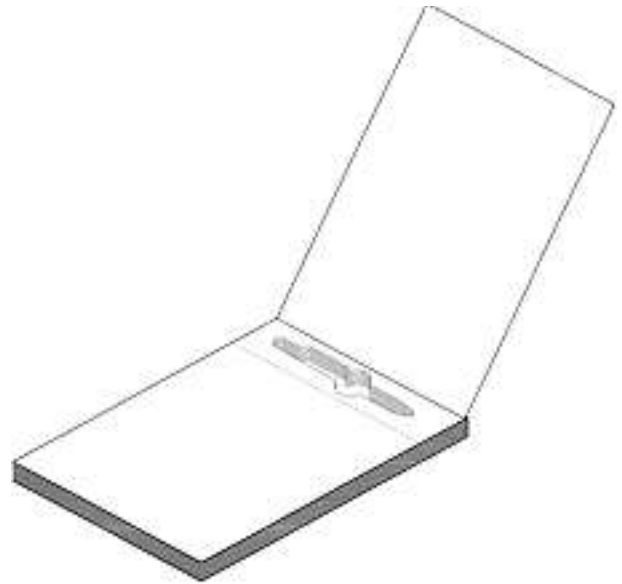
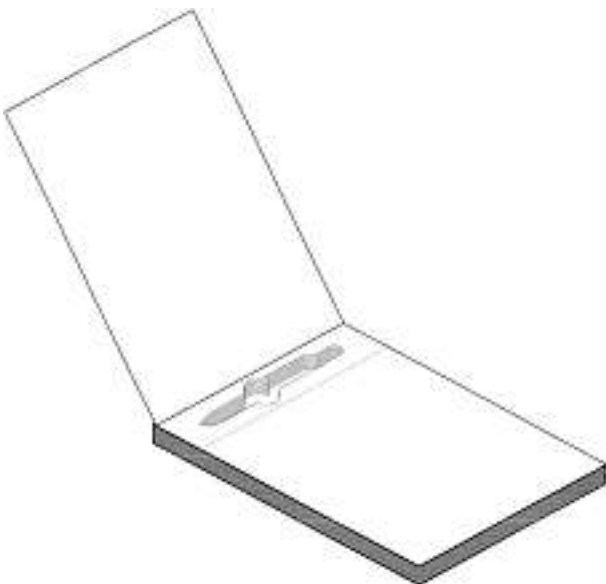
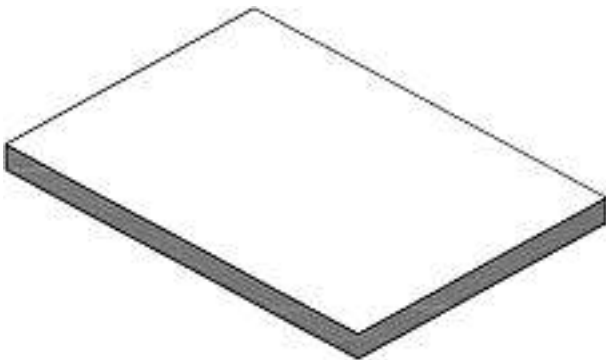
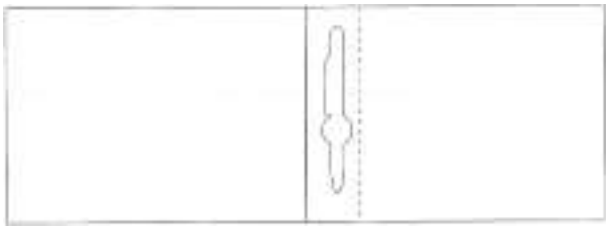
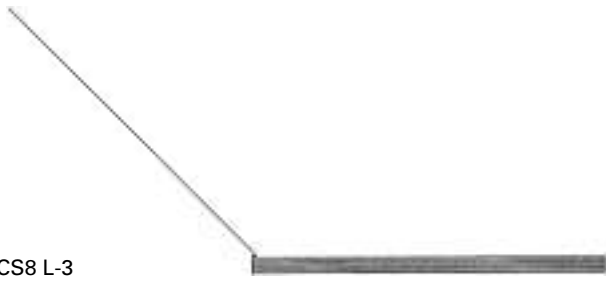

CS8 L-4

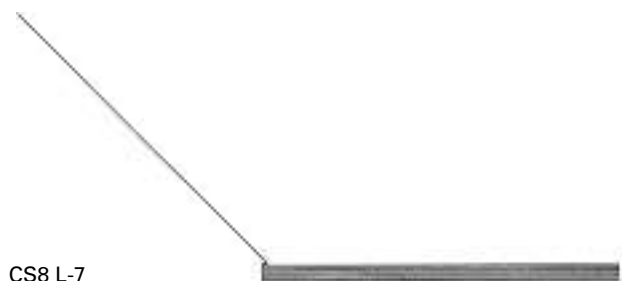
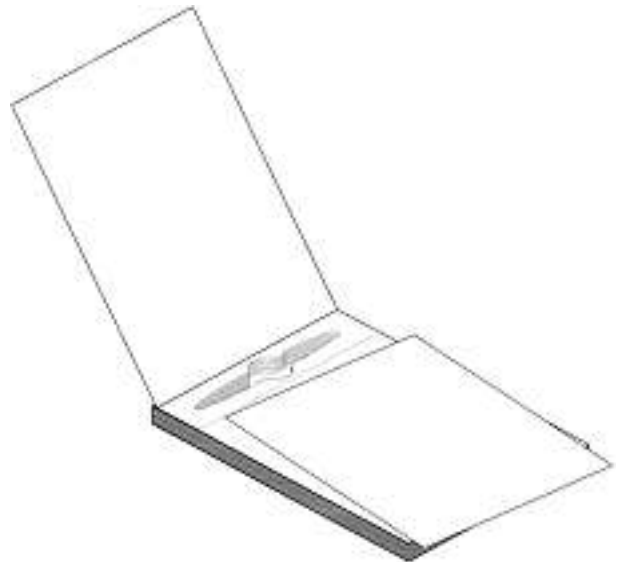
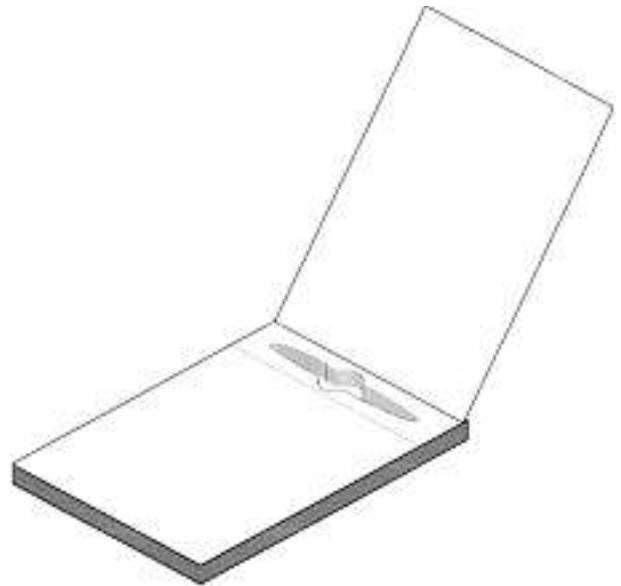
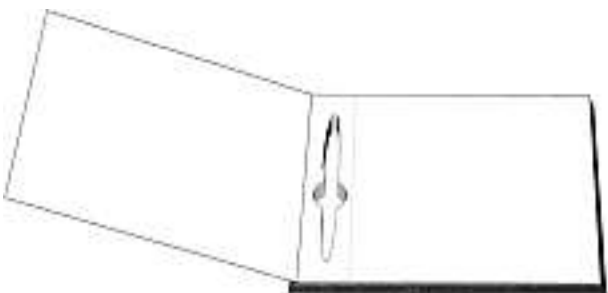
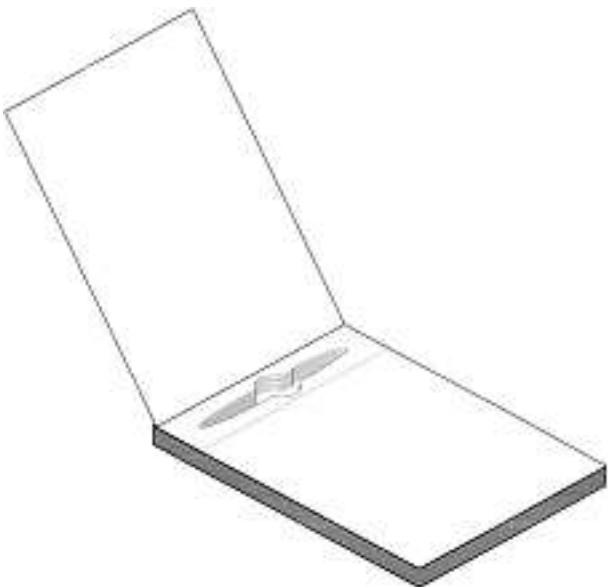
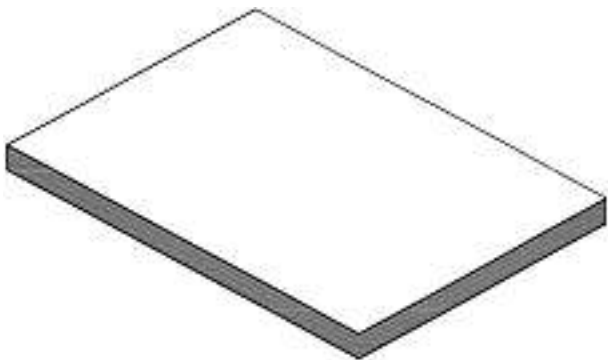
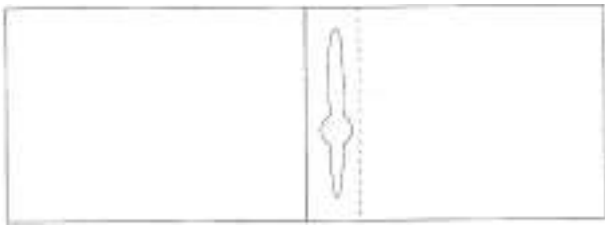

Cl. 19-08 **134 920** 17.03.2008
1 Design – Druckvorlage
Hinterleger: Martin W. Duppenthaler, c/o S. Wolf,
Reinertstrasse 47, 4515 Oberdorf SO
Designer: Adam David Buckner, Albuquerque



1 (Adrenalized Kleider Design)

Cl. 19-99 134 921 10.03.2008
 2 design – signets
 Déposant: Scandinavian Bookmarks Michel & Karlsen GbR,
 Gottfried-Keller Strasse 42, 85521 Ottobrunn, DE
 Designer: Frank Michel, Ottobrunn; Trine Lise Karlsen,
 Ottobrunn
 Mandataire: Lemman Consulting S.A., 1260 Nyon



1



2

Cl. 20-02 134 922 25.02.2008
1 Design – Präsentationsvorrichtung
Hinterleger: Romeo Csaba Kallos, Ringstrasse 4,
4414 Füllinsdorf

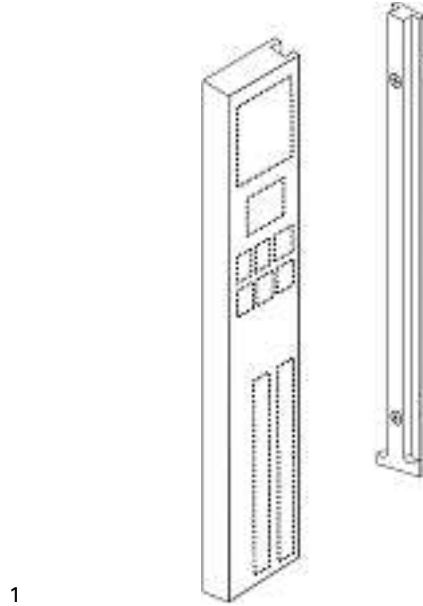

Cl. 20-03 134 923 13.02.2008
2 design – plaques signalétiques
Déposant: MOSER DESIGN SA, Rue du Simplon 3 D,
1006 Lausanne
Designer: Caroline Mesple Moser, Lausanne

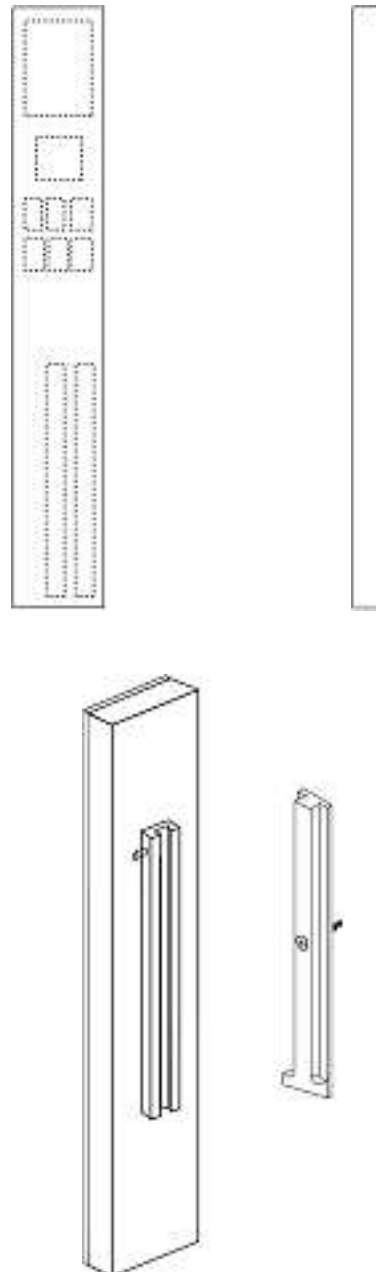
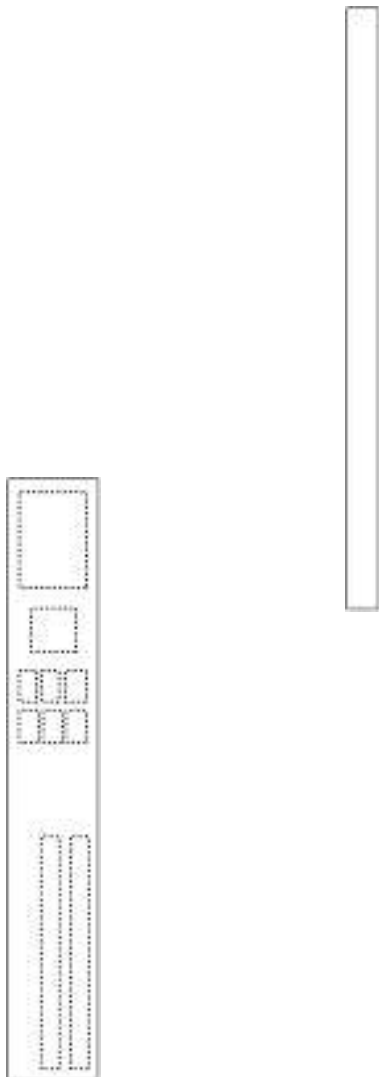

Cl. 20-03 134 924 29.02.2008
17 Design – Terminal
Hinterleger: A-Design AG, Baselstrasse 77, 4500 Solothurn
Designer: Christa Angehrn Reichenbach, Solothurn



2



1





3



5



6



4



7

8



11



9



12



10



13





14



15



16



17

Cl. 20-03 134 925 29.02.2008

1 Design – Werbesäule
 Hinterleger: Peter Schaffer, Lehenweg 13a, 6971 Hard, AT
 Vertreter: BÜCHEL, KAMINSKI & PARTNER
 PATENTANWÄLTE, ESTABLISHMENT, Vaduz (LI),
 Zweigniederlassung Frümser, 9467 Frümser
 Priorität: EM, 01.09.2007



1

Cl. 22-01 134 926 27.03.2008

2 design – pistolets
 Déposant: Sturm, Ruger & Company, Inc., One Lacey Place,
 Southport, CT 06890, US
 Designer: James McGarry, Prescott Valley
 Mandataire: Kirker & Cie S.A., Ingénieurs-Conseils,
 1226 Genève - Thônex
 Priorité: US, 28.09.2007

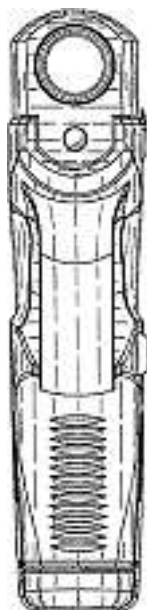
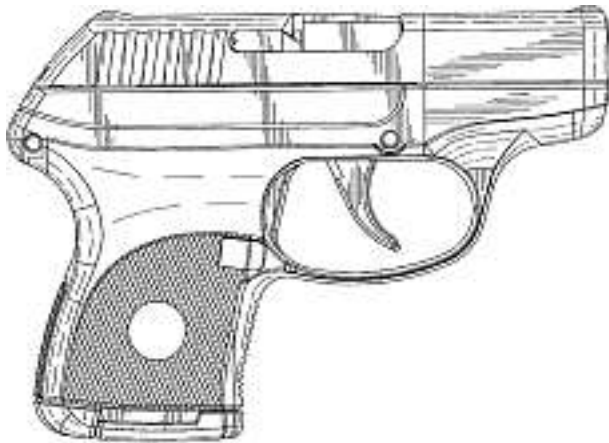
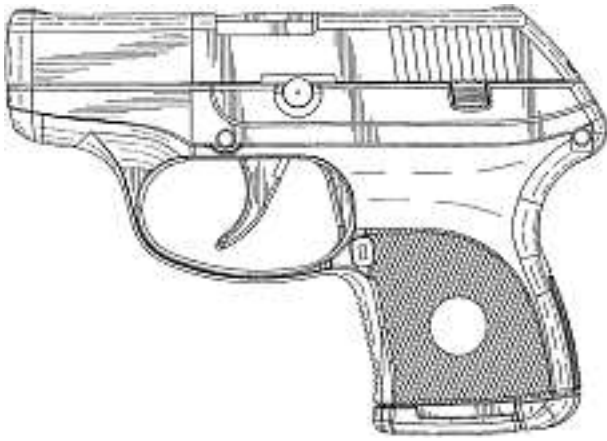

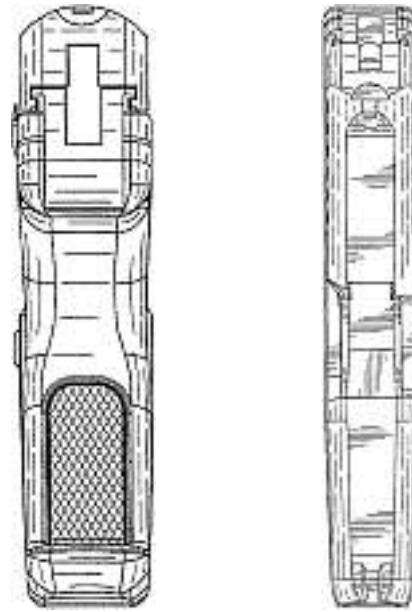
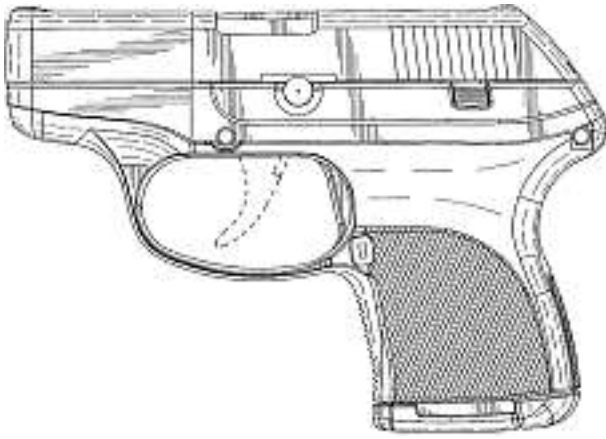

2

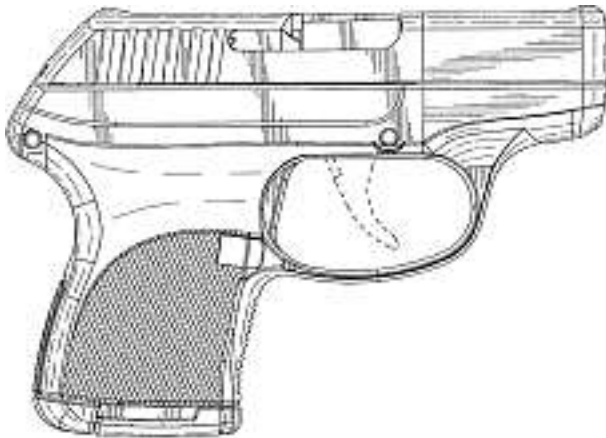

Cl. 24-01 **134 927** 10.03.2008
 1 design – appareil médical de contrôle de pression
 Déposant: International Patents Inc., c/o La Rosière
 (Registered Agents & Trustees) Limited, Maison La Rosière,
 Victoria Mahe, SC
 Designer: Marc Walter Tanner, London; Marko Plevnik,
 London; Philip Biggs, Richmond
 Mandataire: Kirker & Cie S.A., Ingénieurs-Conseils,
 1226 Genève - Thônex
 Priorité: GB, 12.09.2007

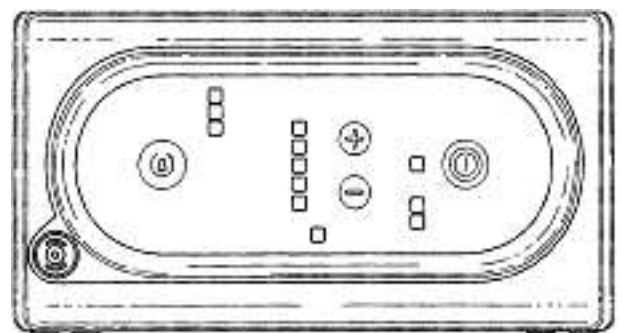
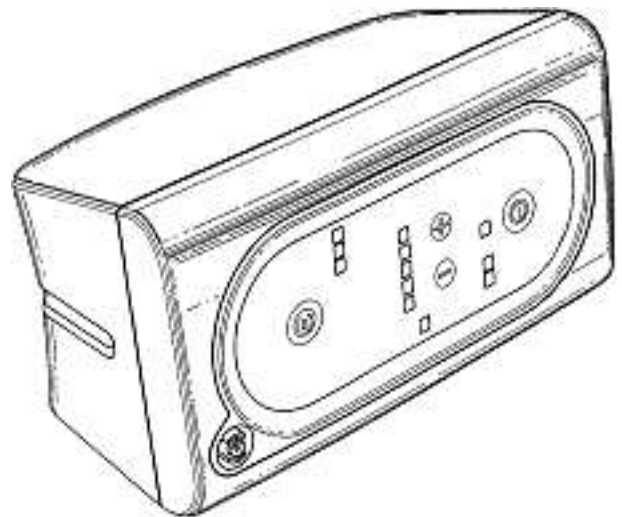
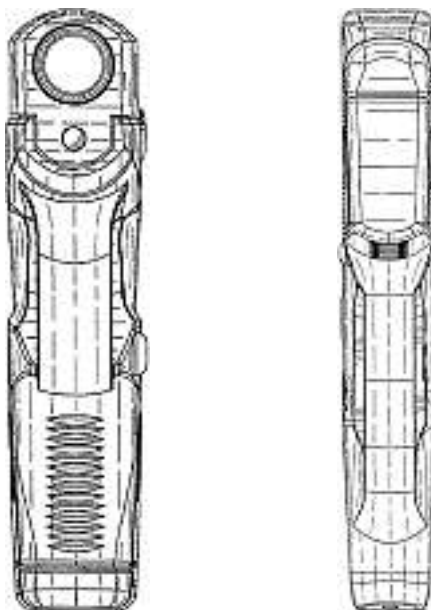

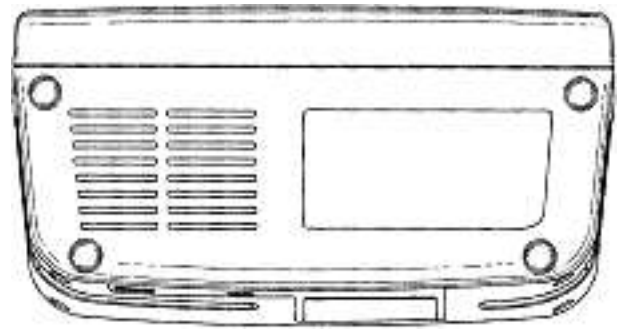
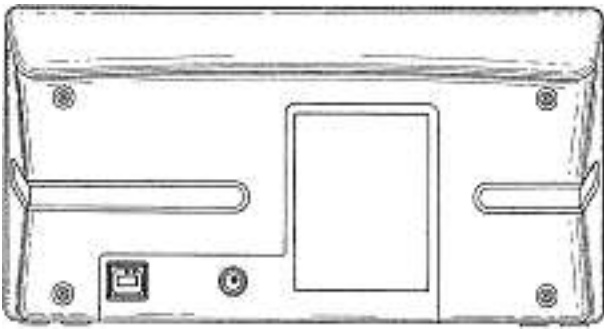

MPM/cl/311214-CH

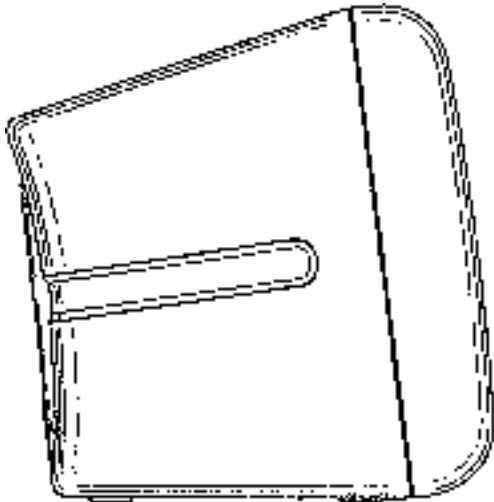

Cl. 24-01 **134 928** 26.03.2008
 9 Design – Absorptionsapparate
 Hinterleger: IGS Italia S.r.l., Via Giordania 48,
 58100 Grosseto, IT
 Designer: Giovanni Zanni, Grosseto; Oscar R. L. De Groen,
 Grosseto
 Vertreter: Frei Patentanwaltsbüro AG, 8032 Zürich
 Priorität: IT, 03.10.2007



1

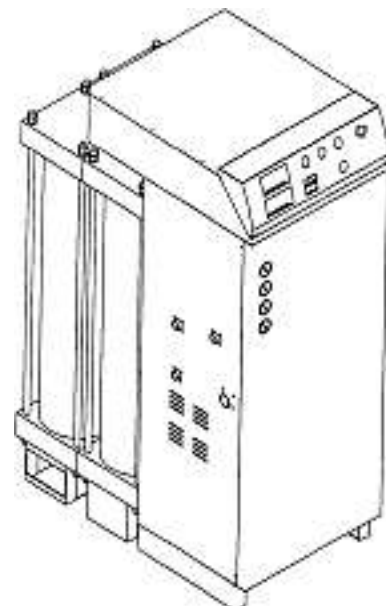

2

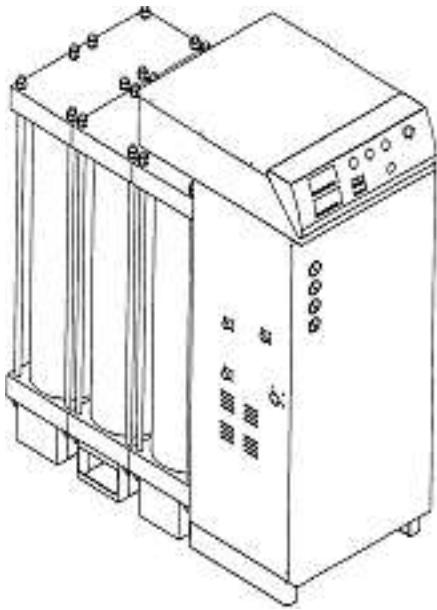

3

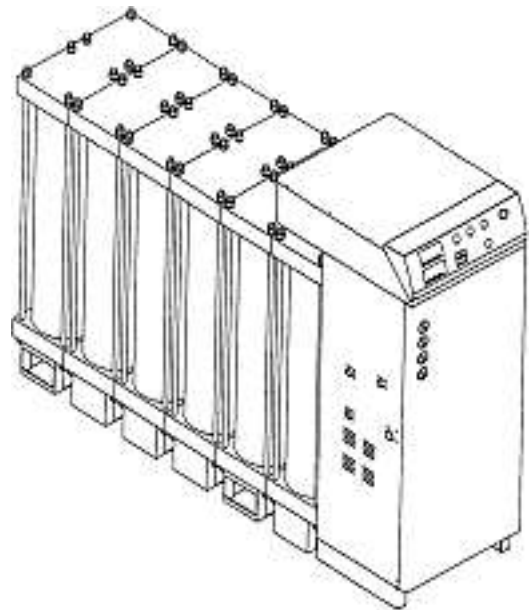

6

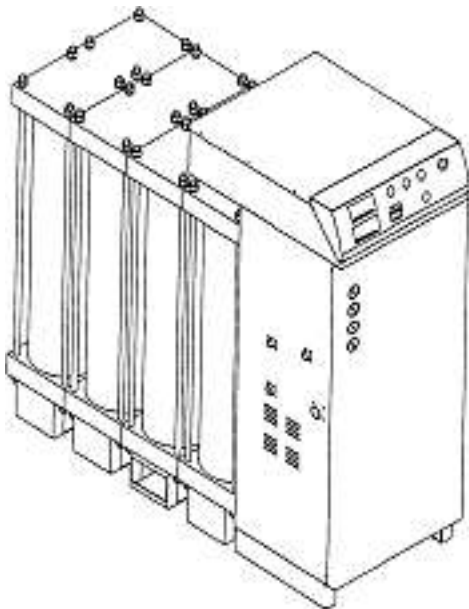

4

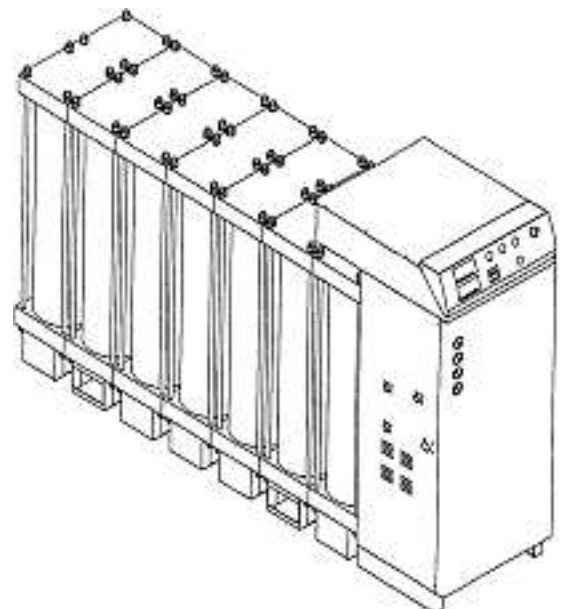

7

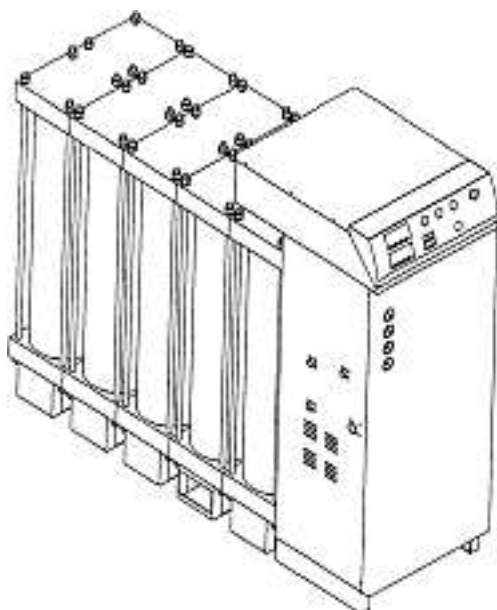

5

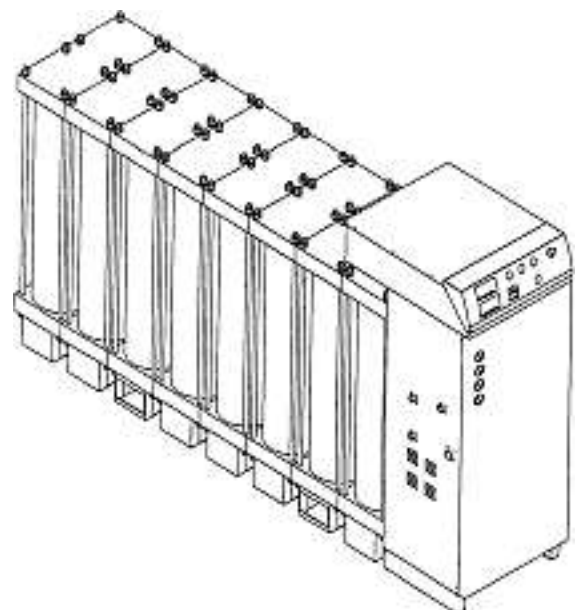

8

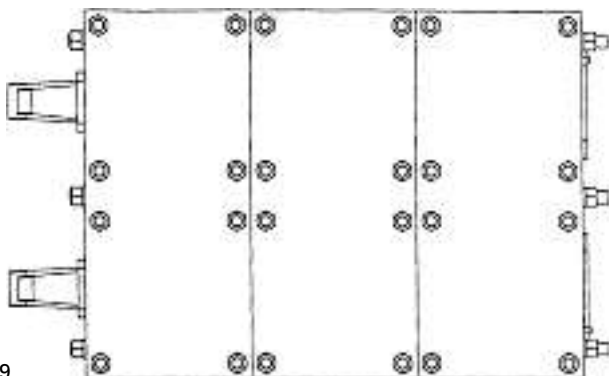
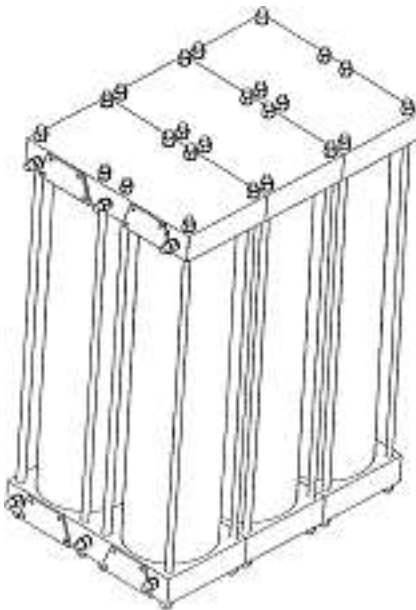
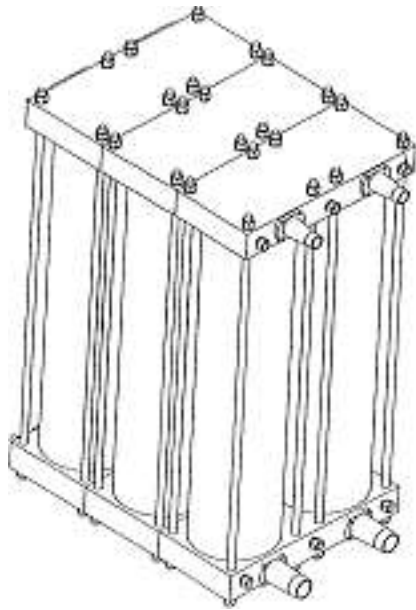

9

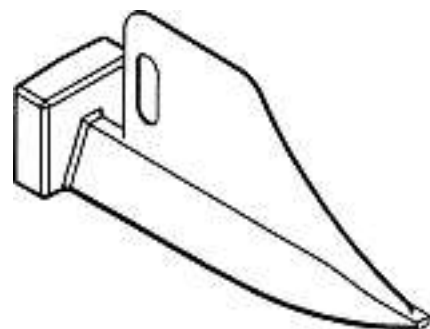
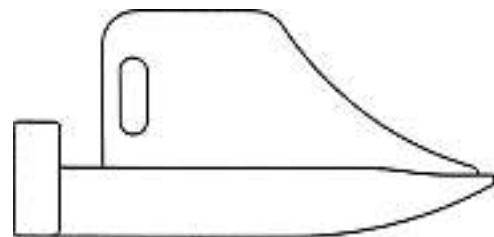
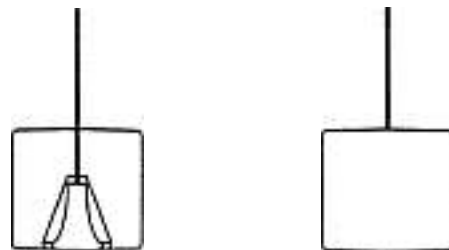
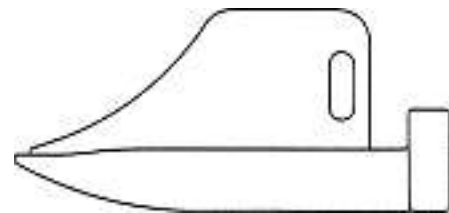
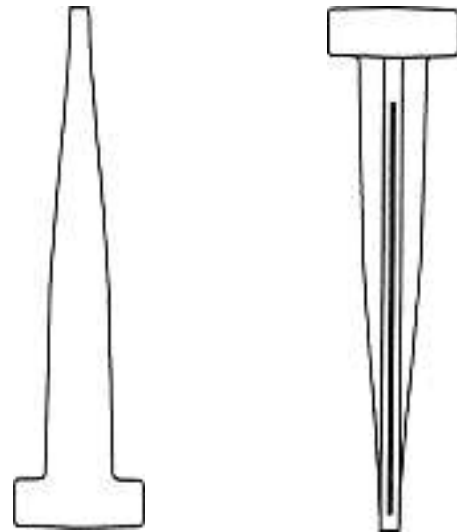

Cl. 24-02 **134 929** 18.03.2008
 1 Design – Zahnärztliches Instrument
 Hinterleger: Directa AB, Box 723, 194 27 Upplands Väsby, SE
 Designer: Dan Ericson, Malmö; Per Larsson, Stockholm;
 Stefan Leffler, Järfälla; Olof Larsson, Hudding
 Vertreter: Troesch Scheidegger Werner AG, Patent- und
 Markenanwälte, 8126 Zumikon
 Priorität: EM, 10.10.2007

D300241

Cl. 25-01 134 930 14.03.2008

1 Design – Profil
 Hinterleger: Brigitte König, Hardstrasse 30,
 4802 Strengelbach; Bruno König, Hardstrasse 30,
 4802 Strengelbach
 Vertreter: Brigitte König, 4802 Strengelbach



3

Cl. 26-02 134 931 07.03.2008

2 Design – Lampe
 Hinterleger: ZECA S.p.A., Strada della Chiara 25, Feletto, IT
 Designer: Piero Chiarabiglio, Feletto
 Vertreter: Schneider Feldmann AG, Patent- und
 Markenanwälte, 8022 Zürich
 Priorität: EM, 10.09.2007



1





Verlängerungen
Prolongations
Prolongazioni

116 686	Cl.	10-04	1 Design
116 889	Cl.	09-03	2 Design
120 560	Cl.	16-03	1 Design

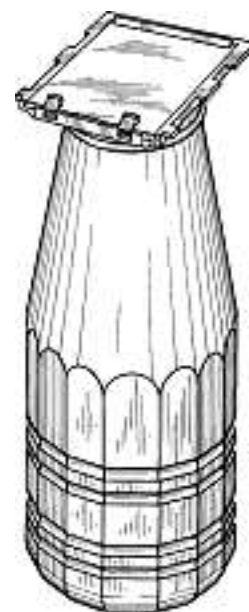
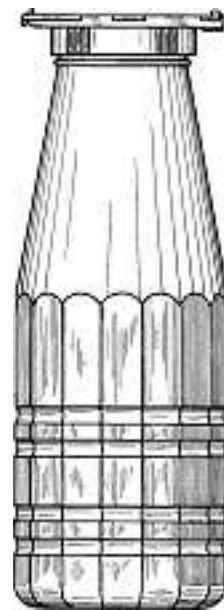
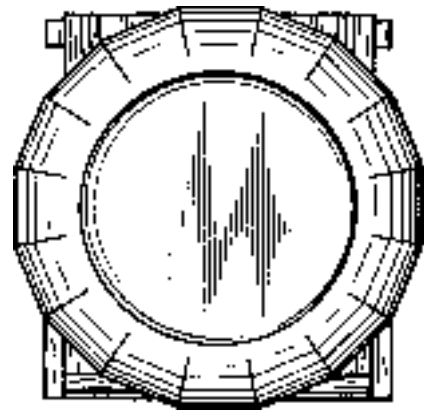
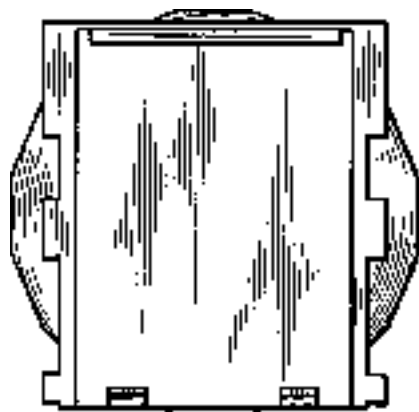
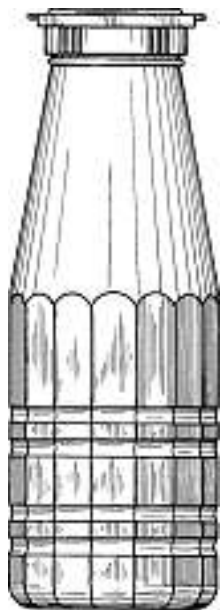
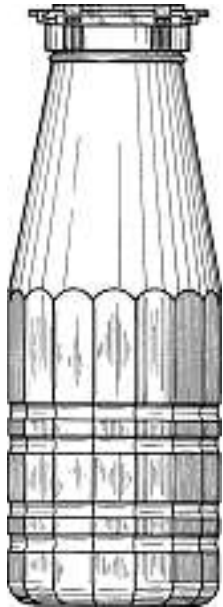

1			
125 033	Cl.	20-03	1 Design
125 057	Cl.	06-01	1 Design
125 188	Cl.	09-01	1 Design
125 230	Cl.	10-04	1 Design
125 313	Cl.	23-03	9 Design
129 654	Cl.	08-05	12 Design
129 667	Cl.	20-03	3 Design
129 677	Cl.	25-01	2 Design
129 679	Cl.	26-04	1 Design
129 683	Cl.	06-03	1 Design
129 701	Cl.	12-15	1 design
129 709	Cl.	23-01	1 Design
129 711	Cl.	24-02	3 design
129 766	Cl.	06-01	5 Design
129 769	Cl.	06-04	38 Design
129 816	Cl.	06-11	1 design
129 827	Cl.	10-07	1 design
129 837	Cl.	15-05	1 Design
129 871	Cl.	09-99	1 Design

Mutationen Modifications Modificazioni

116 345
 116 976
 116 996
 117 010
 117 702
 117 721
 118 417
 119 104
 119 105
 119 755
 120 297
 120 336
 120 409
 120 411
 120 754
 120 825
 120 965
 121 004
 121 216
 121 374
 121 376
 121 457
 121 459
 121 469
 121 470
 121 495
 121 500
 121 638
 121 716
 121 767
 121 798
 121 817
 122 025
 122 050
 122 087
 122 115
 122 214
 122 279
 122 285
 122 309
 122 418
 122 426
 122 442
 122 515
 122 559
 122 779
 122 780
 122 781
 122 856
 122 900
 122 902
 122 932
 122 943
 122 945
 123 014
 123 015
 123 016
 123 109
 123 110
 123 111
 123 162
 123 163
 123 164
 123 168
 123 270
 123 333
 123 334
 123 335
 123 336
 123 337
 123 338
 123 339
 123 340
 123 341
 123 342
 123 378

123 431	125 146
123 473	125 179
123 474	125 219
123 477	125 220
123 479	125 317
123 480	125 318
123 483	125 319
123 484	125 322
123 645	125 323
123 646	125 365
123 647	125 378
123 648	125 379
123 651	125 408
123 725	125 486
123 729	125 487
123 770	125 551
123 771	125 553
123 841	125 556
123 863	125 581
123 865	125 606
123 868	125 607
123 869	125 638
123 923	125 640
123 931	125 641
123 965	125 754
123 966	125 755
124 211	125 756
124 283	125 758
124 321	125 761
124 336	125 762
124 337	125 787
124 338	125 803
124 352	125 835
124 353	125 858
124 354	125 859
124 355	125 878
124 356	125 879
124 379	125 900
124 404	125 989
124 405	125 990
124 475	126 031
124 482	126 064
124 519	126 098
124 520	126 151
124 521	126 152
124 582	126 213
124 667	126 269
124 673	126 270
124 690	126 308
124 691	126 388
124 707	126 398
124 708	126 453
124 709	126 604
124 737	126 716
124 738	126 762
124 740	126 791
124 759	126 802
124 760	126 832
124 761	126 933
124 785	126 934
124 811	126 936
124 812	127 014
124 813	127 015
124 817	127 055
124 837	127 056
124 838	127 057
124 844	127 058
124 845	127 059
124 886	127 188
124 887	127 204
124 911	127 214
124 912	127 227
124 953	127 273
124 954	127 282
125 037	127 324
125 038	127 353
125 039	127 363
125 040	127 364
125 041	127 369
125 042	127 370
125 114	127 374

127 399	130 084
127 586	130 085
127 589	130 164
127 625	130 182
127 628	130 185
127 672	130 229
127 705	130 230
127 706	130 231
127 707	130 232
127 720	130 233
127 742	130 248
127 764	130 287
127 795	130 374
127 816	130 385
127 859	130 501
127 873	130 502
127 874	130 568
127 875	130 598
127 877	130 617
127 974	130 618
127 975	130 619
128 038	130 620
128 122	130 621
128 150	130 641
128 244	130 642
128 250	130 743
128 312	130 789
128 313	130 843
128 314	130 844
128 315	130 884
128 344	130 930
128 388	130 973
128 389	130 974
128 410	131 124
128 411	131 125
128 479	131 126
128 493	131 127
128 529	131 184
128 549	131 185
128 581	131 186
128 614	131 187
128 646	131 274
128 647	131 277
128 648	131 278
128 755	131 322
128 856	131 415
128 965	131 484
128 972	131 492
128 973	131 554
128 974	131 702
128 975	131 771
129 058	131 775
129 298	131 966
129 345	131 985
129 346	132 017
129 347	132 023
129 349	132 024
129 350	132 039
129 351	132 040
129 352	132 041
129 356	132 082
129 360	132 083
129 521	132 108
129 552	132 109
129 570	132 110
129 571	132 345
129 583	132 376
129 584	132 382
129 770	132 383
129 771	132 418
129 795	132 433
129 843	132 501
129 855	132 502
129 856	132 503
129 948	132 504
130 012	132 508
130 033	132 510
130 034	132 536
130 035	132 640
130 037	132 725
130 038	132 740

132 860
 132 876
 132 877
 132 878
 132 879
 132 948
 133 022
 133 023
 133 024
 133 027
 133 127
 133 167
 133 181
 133 213
 133 259
 133 311
 133 313
 133 316
 133 383
 133 521
 133 524
 133 528
 133 558
 133 570
 133 571
 133 572
 133 574
 133 575
 133 576
 133 577
 133 580
 133 658
 133 746
 133 757
 133 975
 134 311
 134 349
 134 373
 134 375
 134 376
 134 421
 134 462
 134 465
 134 473
 134 524
 134 527
 134 528
 134 532
 134 665
 134 742
 134 791

Vertreter Firmaänderung
 Vertreter: BOHEST AG, 4003 Basel

116 889

Namensänderung
 Vertreter Firmaänderung
 Hinterleger: Unilever Schweiz GmbH, Bahnhofstrasse 19,
 8240 Thayngen
 Vertreter: Unilever Schweiz Service AG, 6330 Cham 2

120 408

Vertreter Niederlegung

131 398

Übertragung
 Hinterleger: Special Energy Holding GmbH, Poststrasse 5-6,
 40213 Düsseldorf, DE
 Vertreter: Ritscher & Partner AG, 8125 Zollikerberg

133 879

Übertragung
 Hinterleger: 2962 GmbH, Waltherstrasse 19, 80337 München,
 DE
 Vertreter: Patent- und Rechtsanwälte LangRaible,
 8280 Kreuzlingen

Löschungen Radiations Radiazioni

120 000	Cl.	19-08	1	Design
120 007	Cl.	25-01	1	Design
120 159	Cl.	23-02	1	Design
124 503	Cl.	15-06	1	Design
124 531	Cl.	12-02	1	Design
124 539	Cl.	14-03	1	design
124 597	Cl.	09-01	1	Design
124 613	Cl.	24-01	1	Design
124 615	Cl.	24-02	1	Design
124 616	Cl.	24-02	2	Design
124 626	Cl.	04-02	1	Design
124 627	Cl.	04-02	1	Design
129 064	Cl.	04-02	1	Design
129 065	Cl.	06-01	1	Design
129 068	Cl.	07-02	1	Design
129 069	Cl.	07-02	1	design
129 071	Cl.	07-04	1	Design
129 075	Cl.	09-05	2	design
129 087	Cl.	28-03	4	Design
129 094	Cl.	06-01	4	Design
129 105	Cl.	10-02	25	design
129 108	Cl.	10-07	1	Design
129 162	Cl.	20-03	12	Design
129 179	Cl.	14-03	1	Design
129 185	Cl.	26-05	2	Design
129 188	Cl.	02-04	3	Design
129 191	Cl.	06-01	1	Design
129 194	Cl.	07-02	1	Design
129 204	Cl.	23-01	2	Design
129 205	Cl.	25-01	1	Design
129 207	Cl.	25-01	2	Design
129 208	Cl.	25-03	2	Design
129 210	Cl.	26-05	1	Design
129 211	Cl.	26-05	1	Design
129 277	Cl.	06-01	2	Design