

## Nationale Hinterlegungen

In der folgenden Liste werden die beim Eidgenössischen Institut für Geistiges Eigentum hinterlegten Designs publiziert. Dabei sind der Reihe nach angegeben:

- internationale Klassenangaben
- Hinterlegungsnummer
- Hinterlegungsdatum
- Allenfalls Aufschub der Veröffentlichung
- Anzahl der hinterlegten Designs
- Bezeichnung
- Name und Wohnsitz des Hinterlegers oder der Hinterlegerin
- gegebenenfalls Name und Wohnsitz des Designers oder der Designerin
- Name und Geschäftssitz des allfälligen Vertreters oder der Vertreterin
- gegebenenfalls Prioritätsangaben
- gegebenenfalls Beschreibungstext
- Ordnungsnummer
- Reproduktion des Designs

## Internationale Hinterlegungen

Die bei der Weltorganisation für geistiges Eigentum in Genf hinterlegten Muster und Modelle mit Benennung Schweiz geniessen den gleichen Schutz wie national hinterlegte Designs. Sie werden jeweils im Blatt «Bulletin des dessins et modèles internationaux» veröffentlicht. Dieses Publikationsorgan ist deshalb für eine vollständige Recherche unbedingt beizuziehen.

## Topographien

Angaben über die vom Eidgenössischen Institut für Geistiges Eigentum eingetragenen Topographien von Halbleitererzeugnissen werden in folgender Anordnung aufgeführt:

- Eintragsnummer
- Anmeldedatum
- Bezeichnung
- Name und Wohnsitz des Anmelders oder der Anmelderin
- gegebenenfalls Name und Wohnsitz des Herstellers oder der Herstellerin
- Name und Geschäftssitz des oder der allfälligen Bevollmächtigten
- Datum und Ort einer allfälligen ersten geschäftlichen Verbreitung der Topographie

## Dépôts nationaux

Les designs déposés à l'Institut Fédéral de la Propriété Intellectuelle sont publiés dans la liste qui suit. Les indications y relatives sont mentionnées dans cet ordre:

- indications des classes internationales
- numéro de dépôt
- date de dépôt
- le cas échéant, ajournement de la publication
- nombre des designs déposés
- désignation
- nom et domicile du/de la déposant/e
- le cas échéant, nom et domicile du/de la designer
- nom et domicile de l'éventuel/le mandataire
- le cas échéant, indication de priorité
- le cas échéant, description du design
- numéro attribué à chaque design
- reproduction du design

## Dépôts internationaux

Les dessins et modèles déposés à l'Organisation Mondiale de la Propriété Intellectuelle à Genève qui désignent la Suisse jouissent de la même protection que les dépôts nationaux. Ils sont chaque fois publiés dans la feuille «Bulletin des dessins et modèles internationaux». Pour une recherche complète, il est indispensable de consulter ledit organe de publication.

## Topographies

Les indications concernant les topographies des produits semi-conducteurs, enregistrées par l'Institut Fédéral de la Propriété Intellectuelle, sont énumérées dans l'ordre suivant:

- numéro d'enregistrement
- date de dépôt
- désignation
- nom et domicile du/de la déposant/e
- le cas échéant, nom et domicile du/de la producteur/trice
- nom et domicile de l'éventuel/le mandataire
- date et lieu d'une éventuelle première mise en circulation de la topographie

## Depositi nazionali

Nella lista seguente vengono pubblicati i design depositati presso l'Istituto Federale della Proprietà Intellettuale. Sono menzionati nel seguente ordine:

- indicazioni delle classi internazionali
- numero di deposito
- data del deposito
- se del caso, indicazione che la pubblicazione è stata differita
- numero dei design depositati
- designazione
- nome e domicilio del depositante
- se del caso, nome e domicilio del designer
- nome e sede di un eventuale mandataro
- se del caso, indicazioni di priorità
- se del caso, descrizione del design
- numero d'ordine
- riproduzione del design

## Depositi internazionali

I disegni e modelli depositati presso l'Organizzazione Mondiale della Proprietà Intellettuale a Ginevra con denominazione Svizzera godono della medesima protezione del deposito nazionale. Essi vengono pubblicati ogni volta nel foglio «Bulletin des dessins et modèles internationaux». Quest'organo di pubblicazione è da consultare se si vuole effettuare una ricerca completa.

## Topografie

Le indicazioni concernenti le topografie di prodotti a semiconduttori depositati presso l'Istituto Federale della Proprietà Intellettuale sono menzionate nell'ordine seguente:

- numero di registrazione
- data del deposito
- designazione
- nome e domicilio del/la richiedente
- se del caso, nome e domicilio del/la produttore/trice
- nome e sede di un eventuale mandataro
- data e luogo di un'eventuale prima messa in circolazione della topografia

**Hinterlegungen**  
**Dépôts**  
**Depositi**

Fin de la période ajournement de la publication:  
 Cl. 10-02 130 141 02.12.2003  
 3 design – montres  
 Déposant: Lac Investment S.A., Route de Founex 6a,  
 1296 Coppet  
 Designer: Dick Steenmann, Hermance  
 Mandataire: Griffes Consulting S.A., 1206 Genève



MO-116513-CH





MO-116514-CH



MO-116515-CH

Ende aufgeschobene Publikation:  
 Cl. 11-01 **130 217** 19.12.2003  
 10 Design – Schmuck- und Juwelierwaren  
 Hinterleger: Xavier de Fraissinette AG, Zugerstrasse 74,  
 6340 Baar  
 Designer: Xavier de Fraissinette, Lyon  
 Vertreter: Zimmerli, Wagner & Partner AG, 8001 Zürich

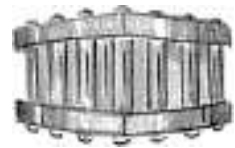

1





2



4

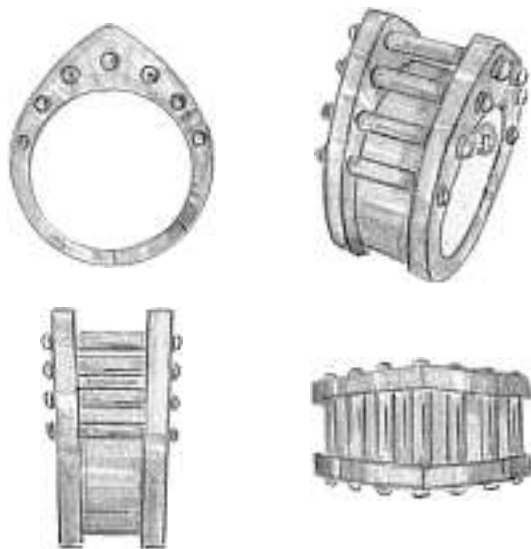

3



5





7



6

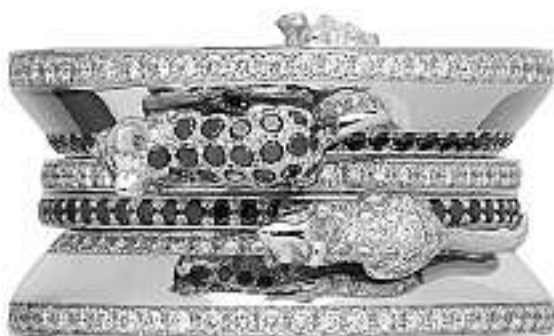

8

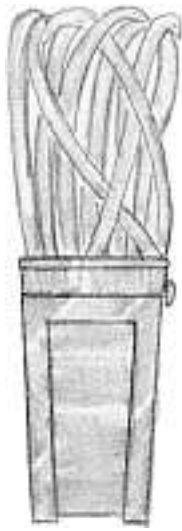

9





10

Cl. 01-03 130 607 08.04.2004  
10 Design – Käse  
Hinterleger: Züger Frischkäse AG, Industrie Haslen,  
9245 Oberbüren  
Designer: Christof Züger, Oberbüren



1



2



3



4



5



6



7



10

Cl. 02-03 130 608 31.03.2004

1 Design - Schutzhelm

Hinterleger: Take Two Sport Mode AG, Lohwisstrasse 42, 8123 Ebmatingen

Designer: Claudius Pfister, Ebmatingen; Antonio Mangone, Cella

Vertreter: Froiep Renggli, Rechtsanwälte, 8034 Zürich



8



9







RST/10004563

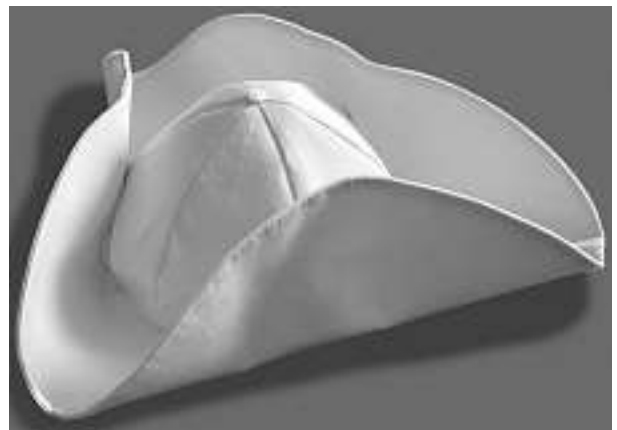
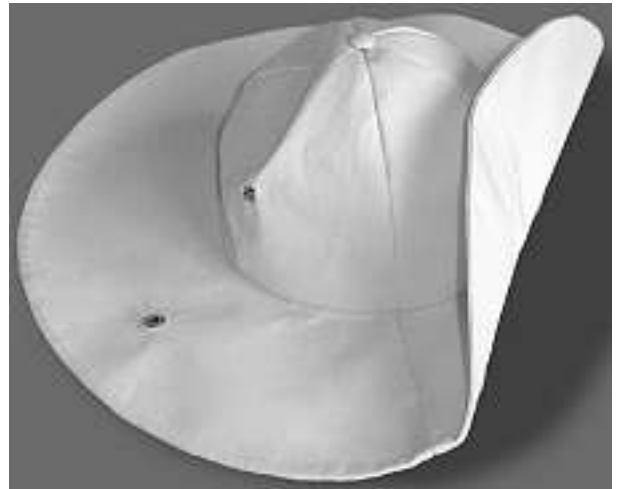
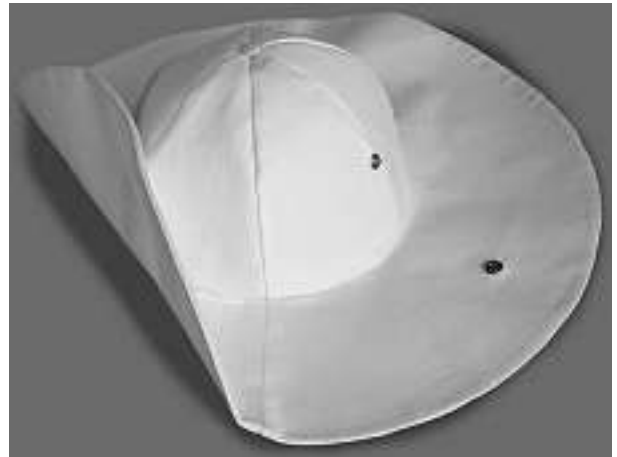

Cl. 02-03                      130 609                      05.04.2004  
 12 Design – Hüte  
 Hinterleger: Fantop GmbH, c/o Spälti Consulting,  
 Bahnhofstrasse 6, 8302 Kloten  
 Designer: Rolando Gazzotti, Basel  
 Vertreter: ullmann:schwenninger gmbh, intellectual property  
 protection, 8800 Thalwil



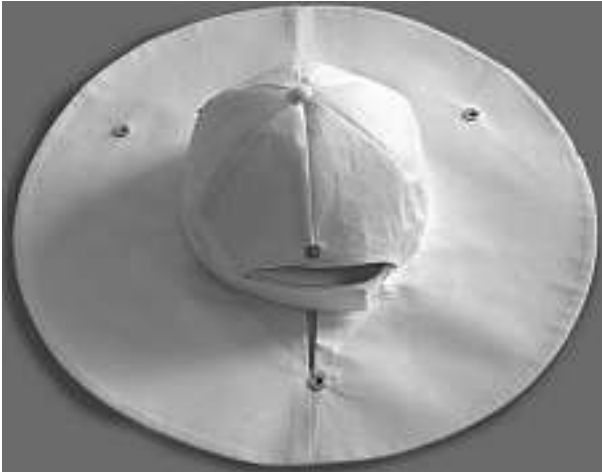

1

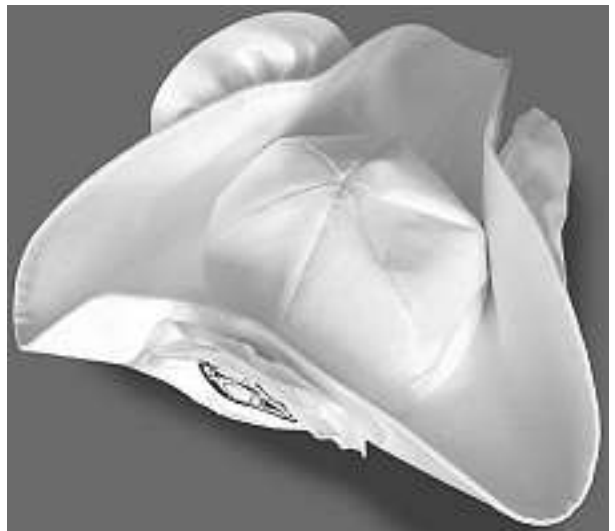

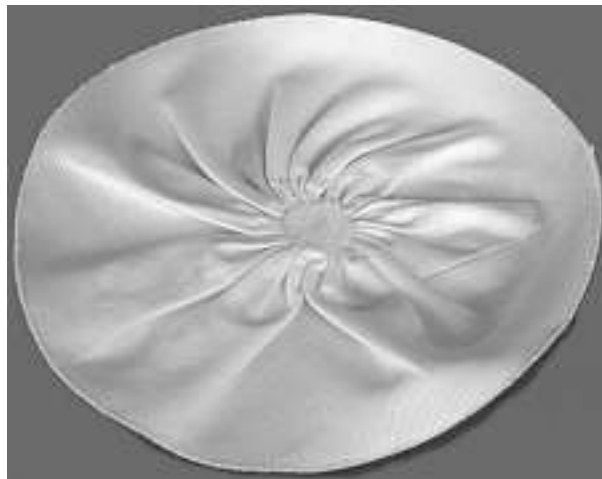

2





3



4

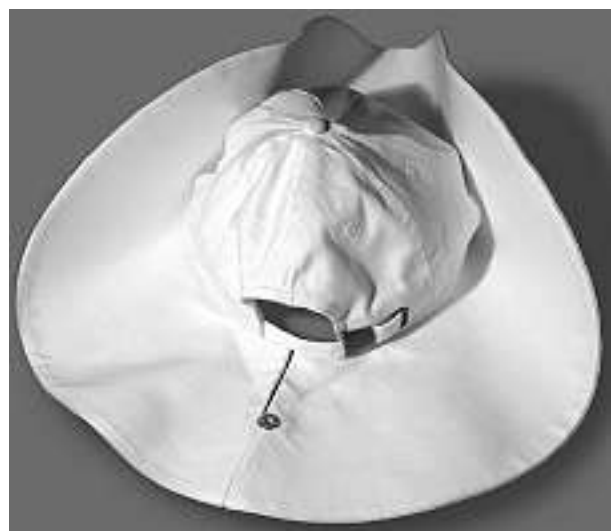

5





6



7

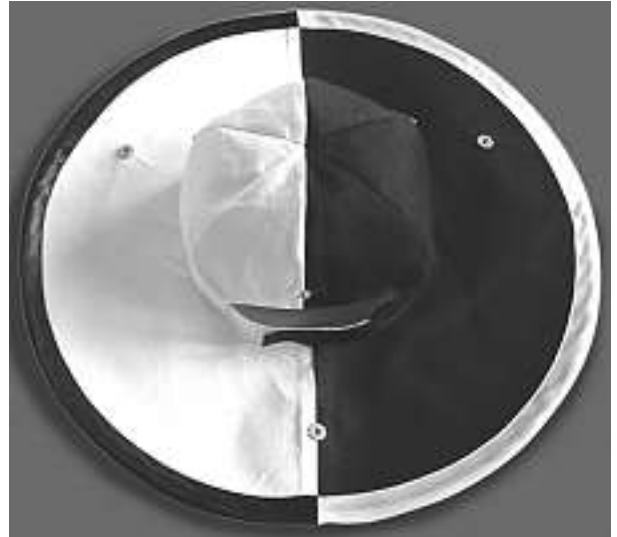
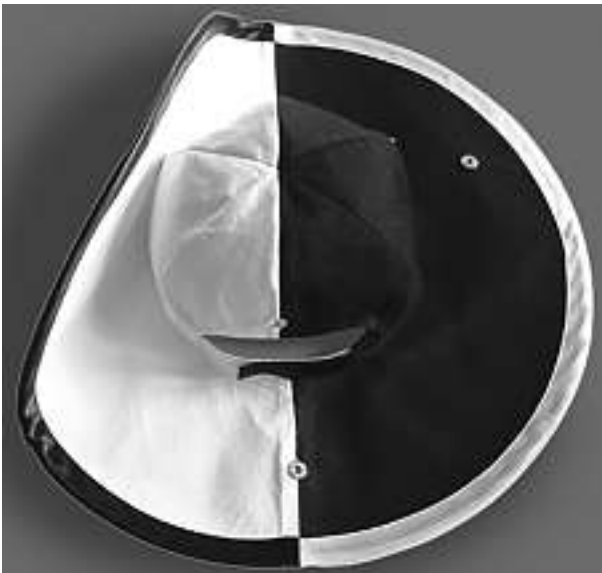
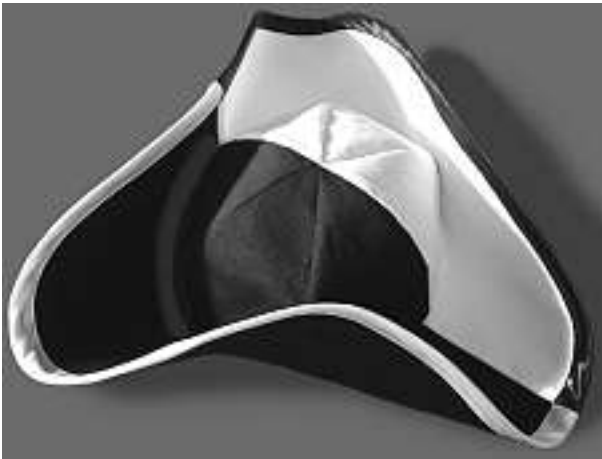

8



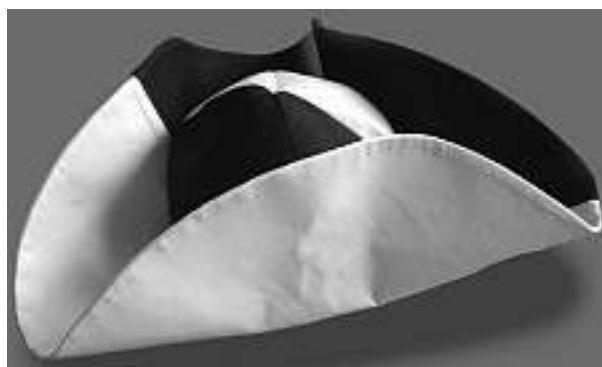

10

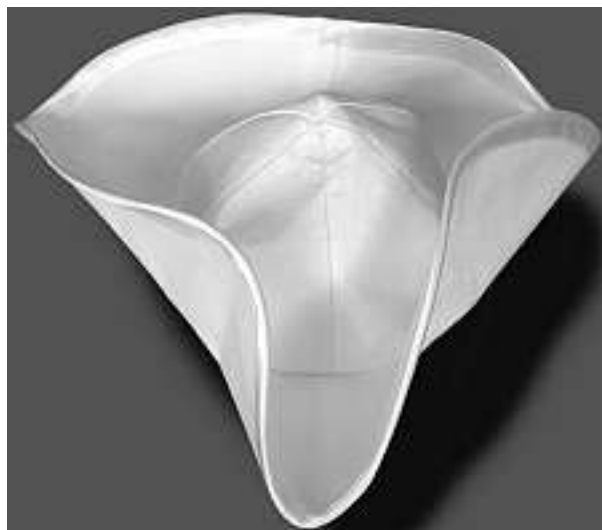
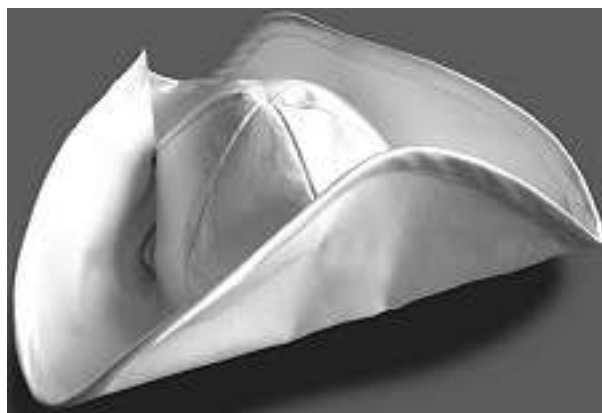
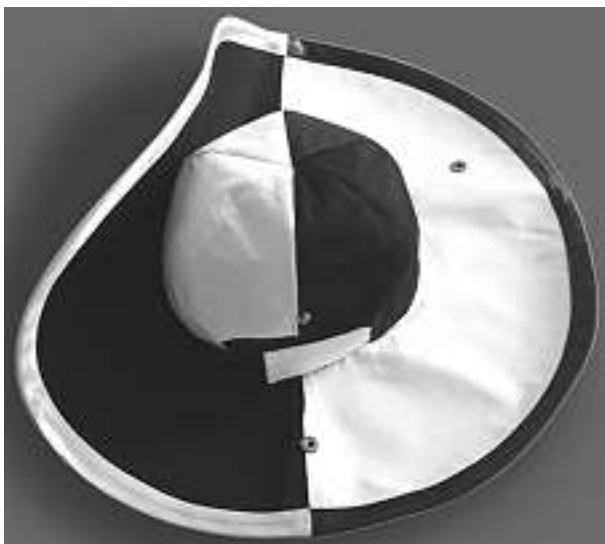

9

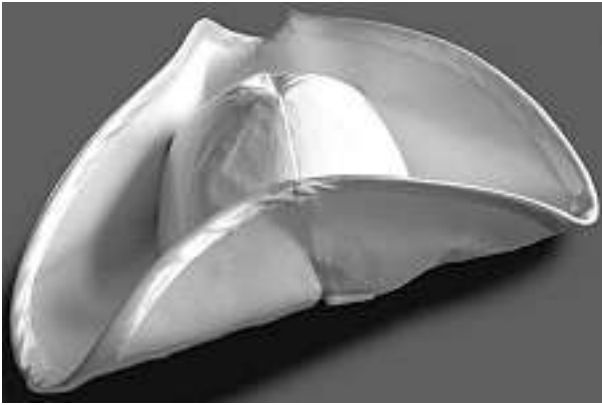

11







12

Cl. 02-07 130 610 06.04.2004

1 Design – Gurt

Hinterleger: Sabino Di Mambro, Flurstrasse 8, 3014 Bern;

Enea Angeli, Flurstrasse 8, 3014 Bern; Laura Angeli

Di Mambro, Flurstrasse 8, 3014 Bern

Vertreter: Sabino Di Mambro, 3014 Bern



Buffaloo-Belt

Cl. 03-01 130 611 05.04.2004

3 Design – Rucksack, Ranzen

Hinterleger: Martin Moll, Badstrasse 55, Bad Boll, DE

Vertreter: Troesch Scheidegger Werner AG, 8126 Zumikon

Priorität: EM, 12.01.2004





D300034 - 1





D300034 - 2





Cl. 06-01, 06-06      **130 613**      05.04.2004  
 5 Design – Sitz/Liege und Teile  
 Hinterleger: Micheline Hauchecorne, Insstrasse 15 B,  
 3237 Brüttelen

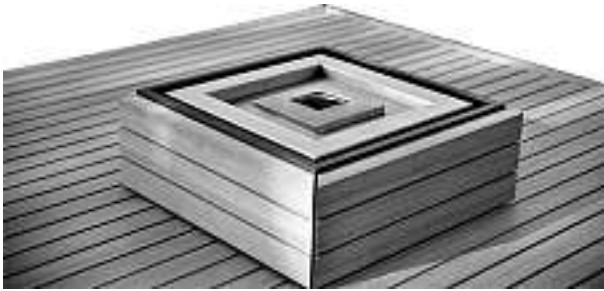

C 4.0



C 4.4



C 4.1



C 4.2



C 4.3

Cl. 06-03, 06-04      **130 614**      31.03.2004  
 3 Design – Garderobe, Gestell, Salontisch  
 Hinterleger: Samuel Lüscher, Napfweg 6, 4800 Zofingen

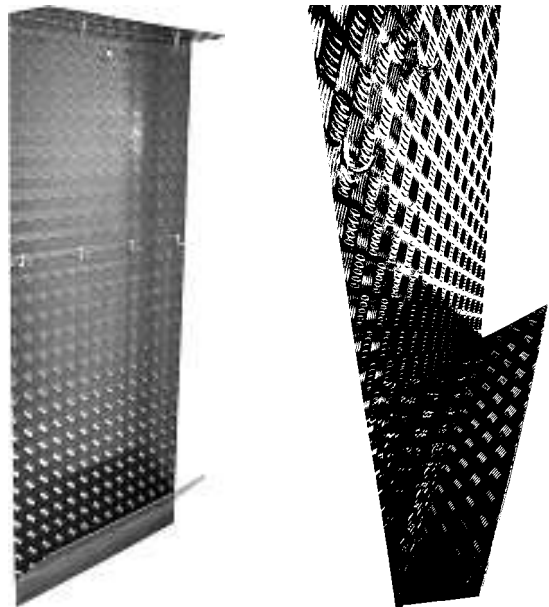

Ga 1





Ge 2

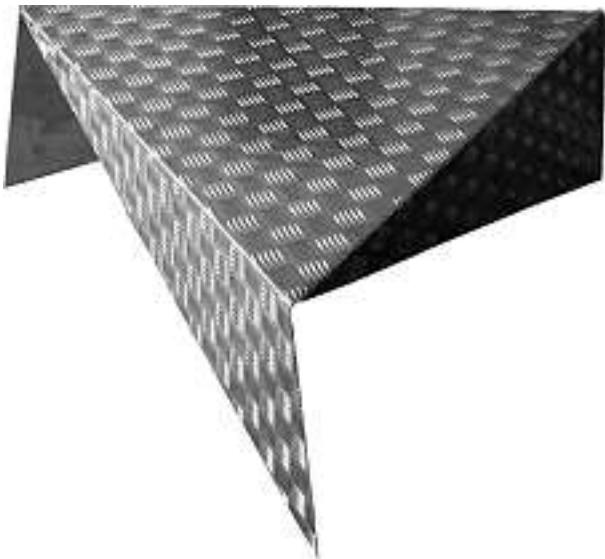

Sa 3

Cl. 06-06 **130 615** 11.05.2004  
 4 design – pannello per scaffalatura e accessori  
 Depositante: PONTEGGI DALMINE S.p.A., Via Bresciani 16,  
 46040 Gazoldo Degli Ippoliti (Mantova), IT  
 Designer: Salvatore Mura, Milano  
 Mandatario: Studio Rapisardi S.A., 6900 Lugano  
 Priorità: IT, 21.11.2003



1

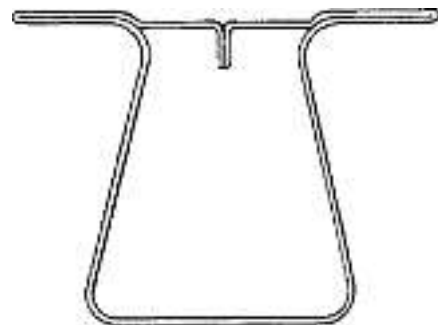
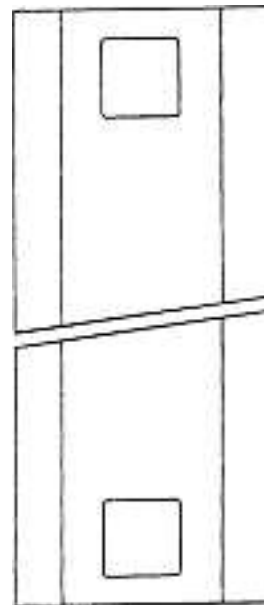

2

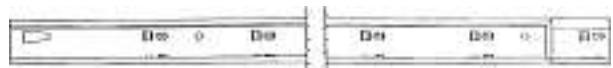

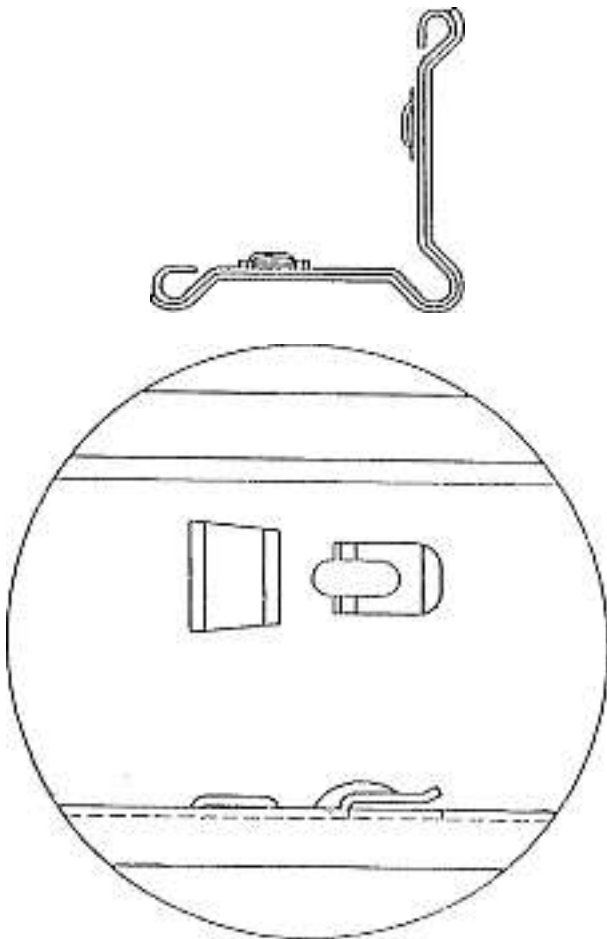

3

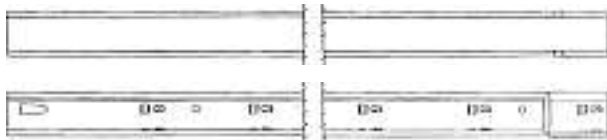

4

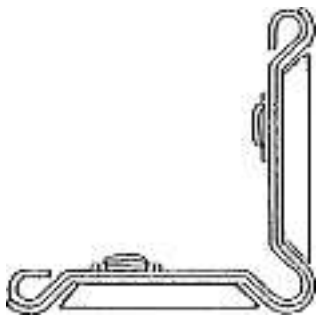

Cl. 07-01                      **130 616**                      07.04.2004  
 1 Design – Krug  
 Hinterleger: Pi-Design AG, Kantonsstrasse 100,  
 6234 Triengen  
 Designer: Jorgen Bodum, St. Niklausen  
 Vertreter: A.W. Metz & Co. AG, 8024 Zürich  
 Priorität: DK, 21.10.2003



52533-CH-7-DA

Cl. 07-01 **130 617** 21.04.2004  
 1 Design – Servierplatte  
 Hinterleger: Dart Industries Inc., 14901 S. Orange Blossom Trail, Orlando / FL, US  
 Designer: Douglas M. Laib, Orlando  
 Vertreter: A. Braun, Braun, Héritier, Eschmann AG, Patentanwälte, 4051 Basel  
 Priorität: US, 29.10.2003

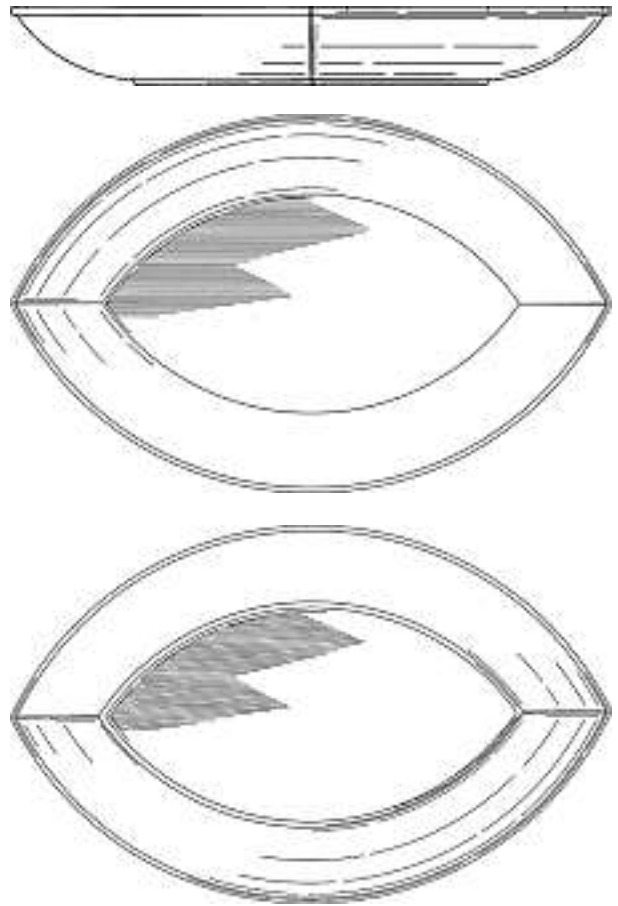
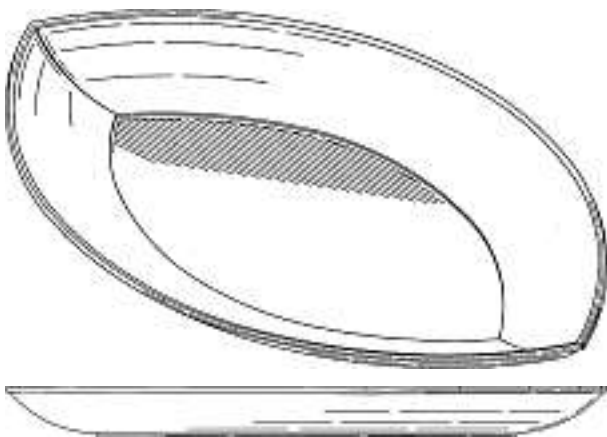

D. 12/2004

Cl. 07-01 **130 618** 21.04.2004  
 1 Design – Servierschüssel mit Deckel  
 Hinterleger: Dart Industries Inc., 14901 S. Orange Blossom Trail, Orlando / FL, US  
 Designer: Douglas M. Laib, Orlando  
 Vertreter: A. Braun, Braun, Héritier, Eschmann AG, Patentanwälte, 4051 Basel  
 Priorität: US, 29.10.2003

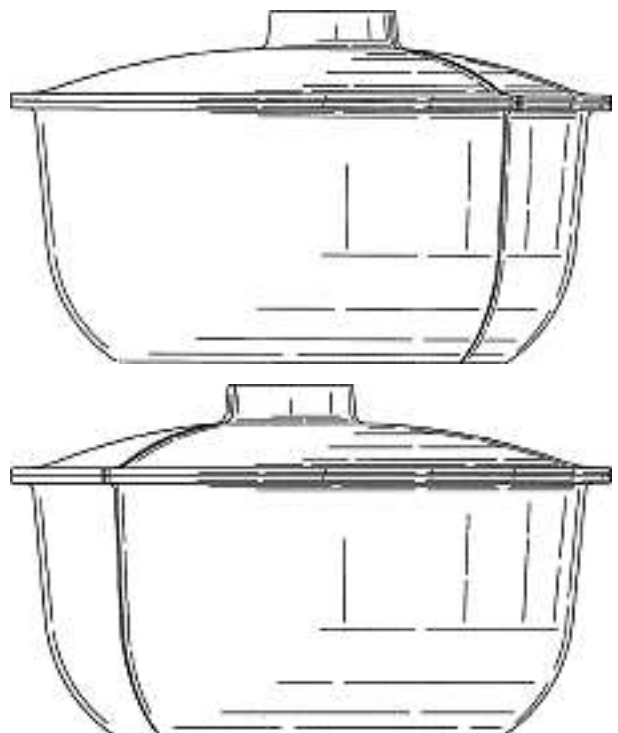



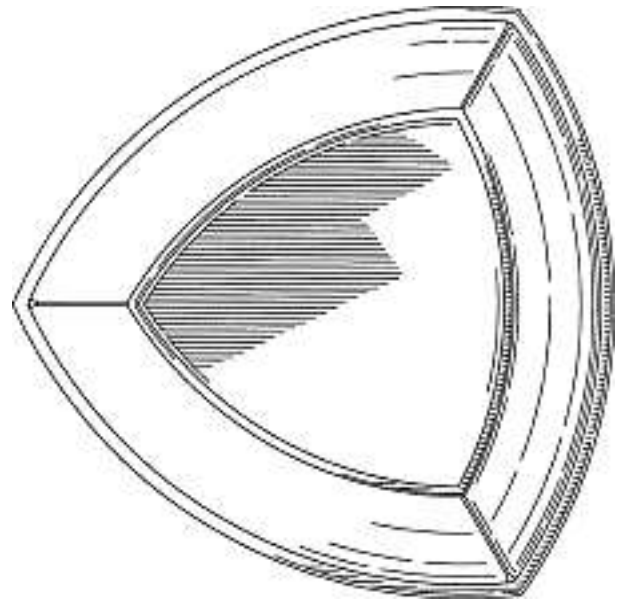
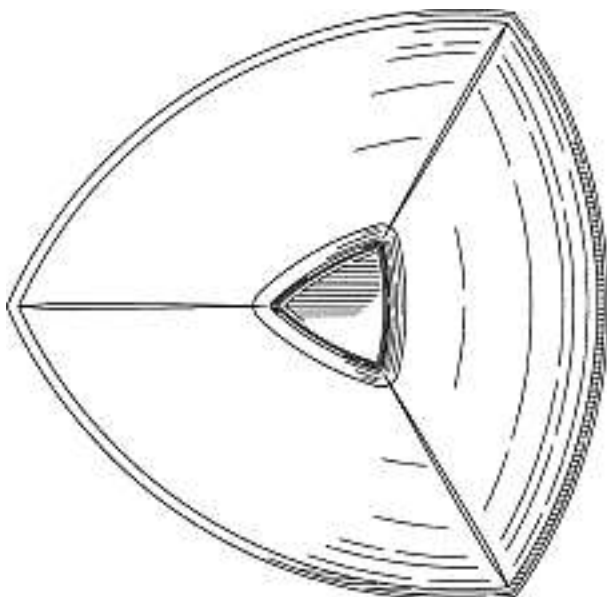
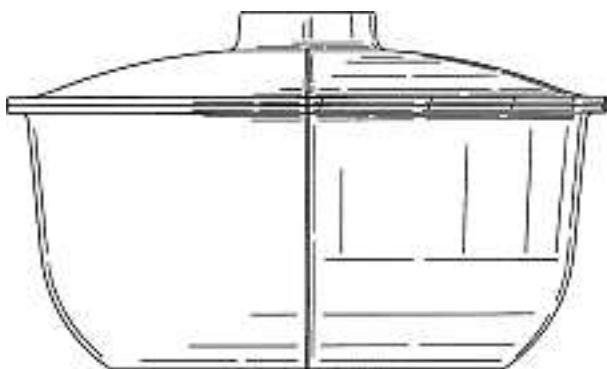
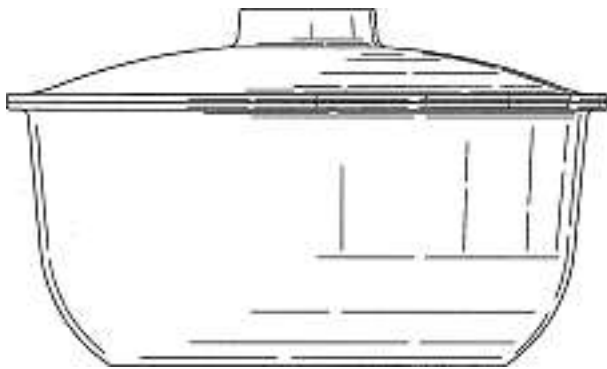
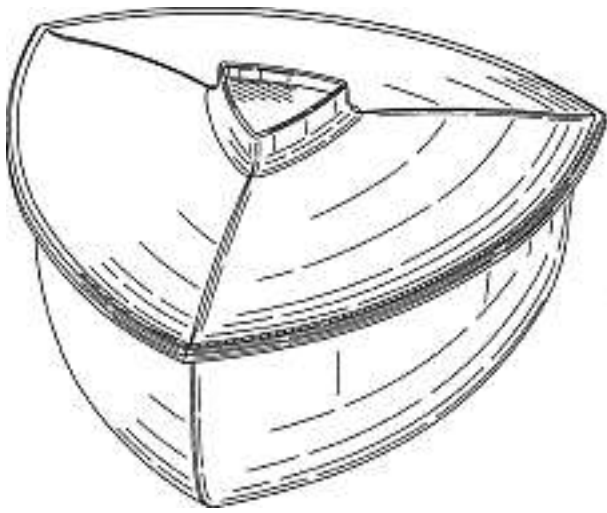

D. 13/2004

Cl. 07-01 **130 619** 21.04.2004  
 1 Design – Servierschüssel  
 Hinterleger: Dart Industries Inc., 14901 S. Orange Blossom  
 Trail, Orlando / FL, US  
 Designer: Douglas M. Laib, Orlando  
 Vertreter: A. Braun, Braun, Héritier, Eschmann AG,  
 Patentanwälte, 4051 Basel  
 Priorität: US, 29.10.2003

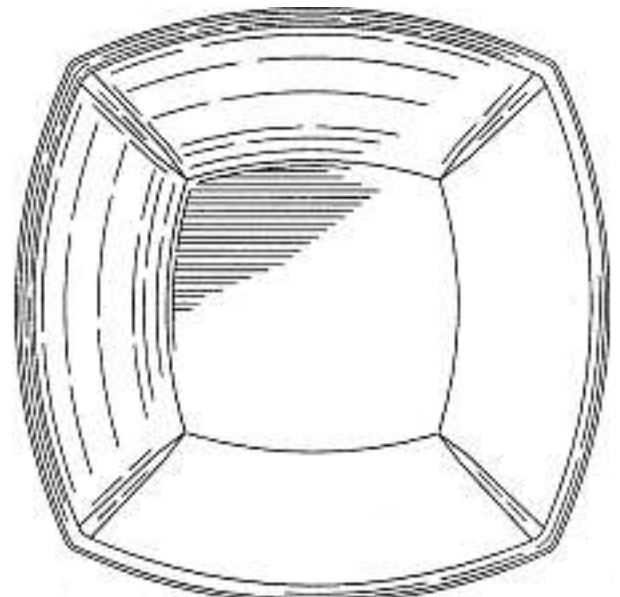
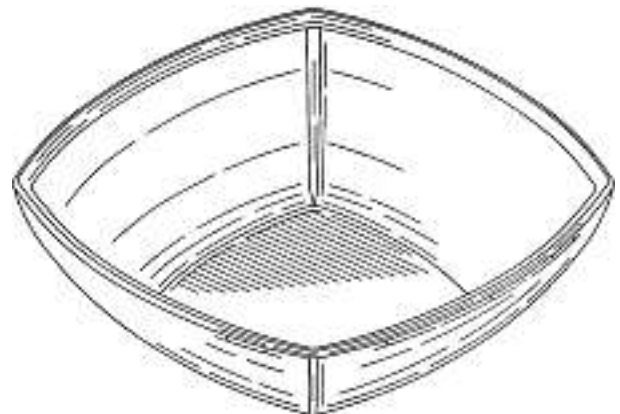

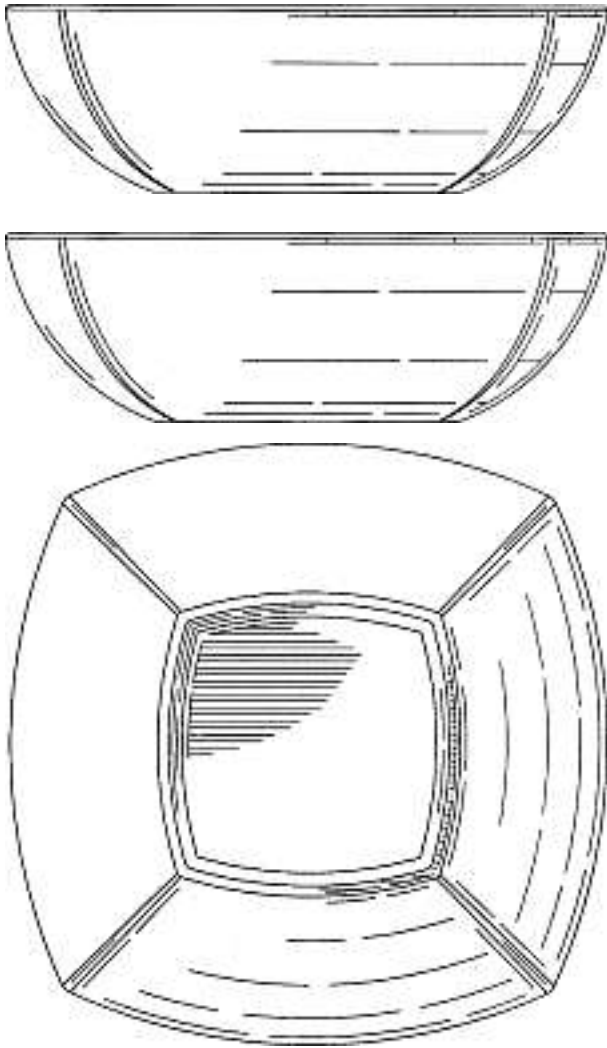

D. 14/2004

Cl. 07-01 **130 620** 21.04.2004  
 1 Design – Teller  
 Hinterleger: Dart Industries Inc., 14901 S. Orange Blossom Trail, Orlando / FL, US  
 Designer: Douglas M. Laib, Orlando  
 Vertreter: A. Braun, Braun, Héritier, Eschmann AG, Patentanwälte, 4051 Basel  
 Priorität: US, 29.10.2003

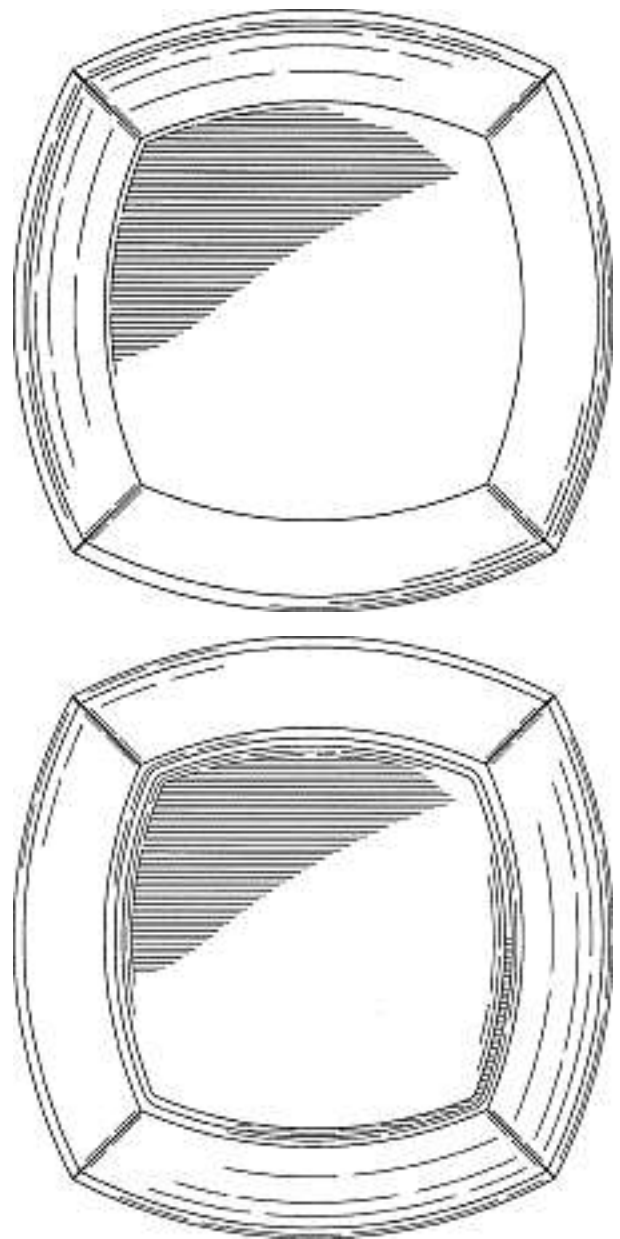
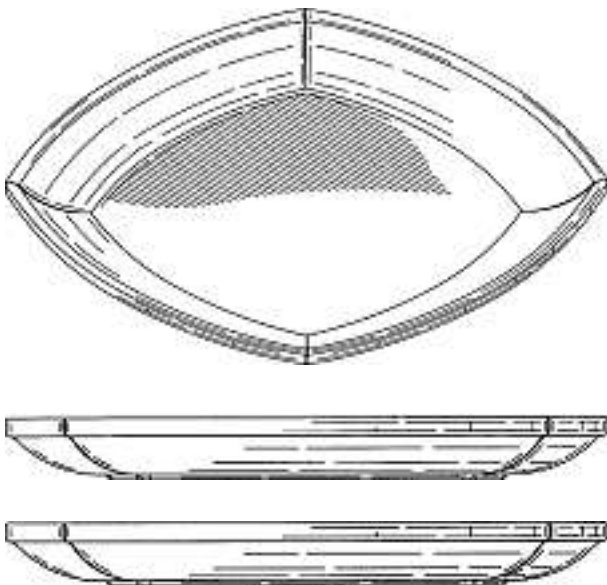

D. 15/2004

Cl. 07-01 **130 621** 21.04.2004  
 2 Design – Geschirr  
 Hinterleger: Dart Industries Inc., 14901 S. Orange Blossom Trail, Orlando / FL, US  
 Designer: Douglas M. Laib, Orlando  
 Vertreter: A. Braun, Braun, Héritier, Eschmann AG, Patentanwälte, 4051 Basel  
 Priorität: US, 29.10.2003

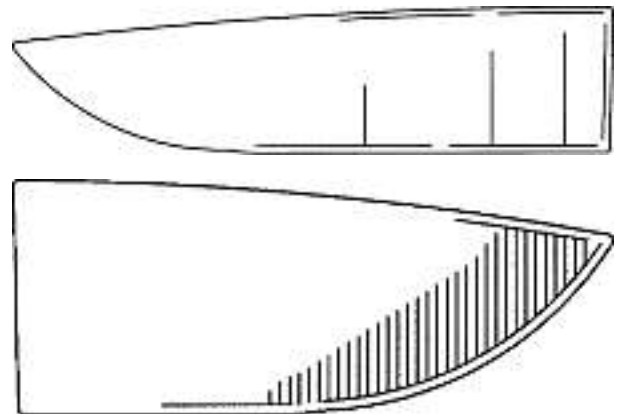

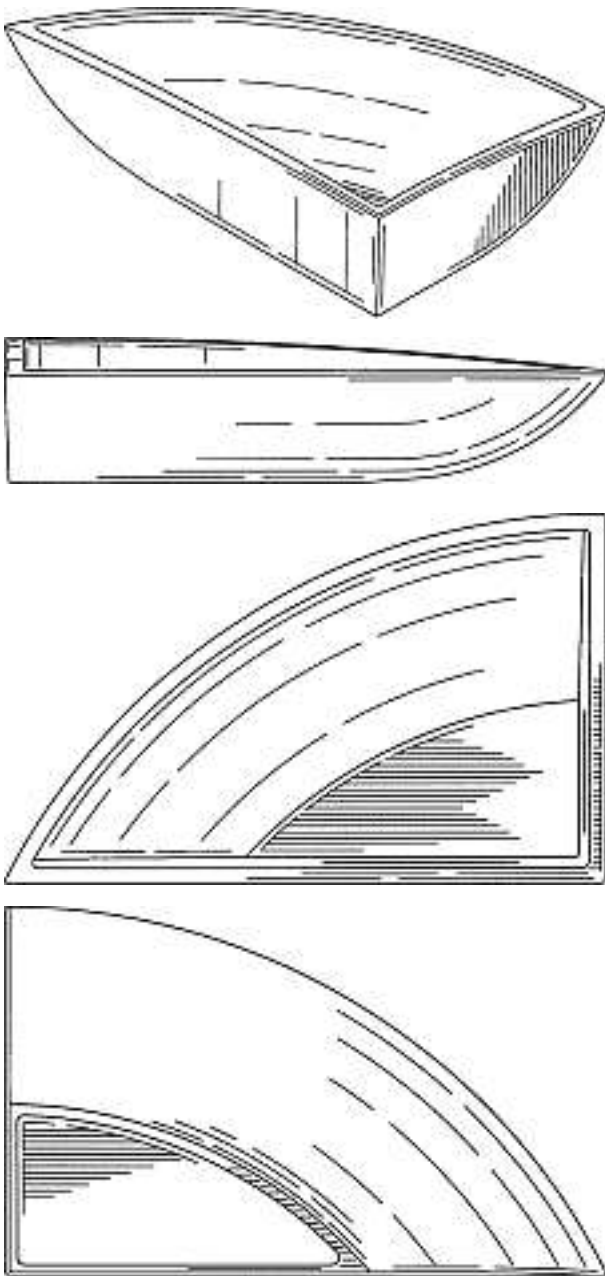

D. 16/2004-1

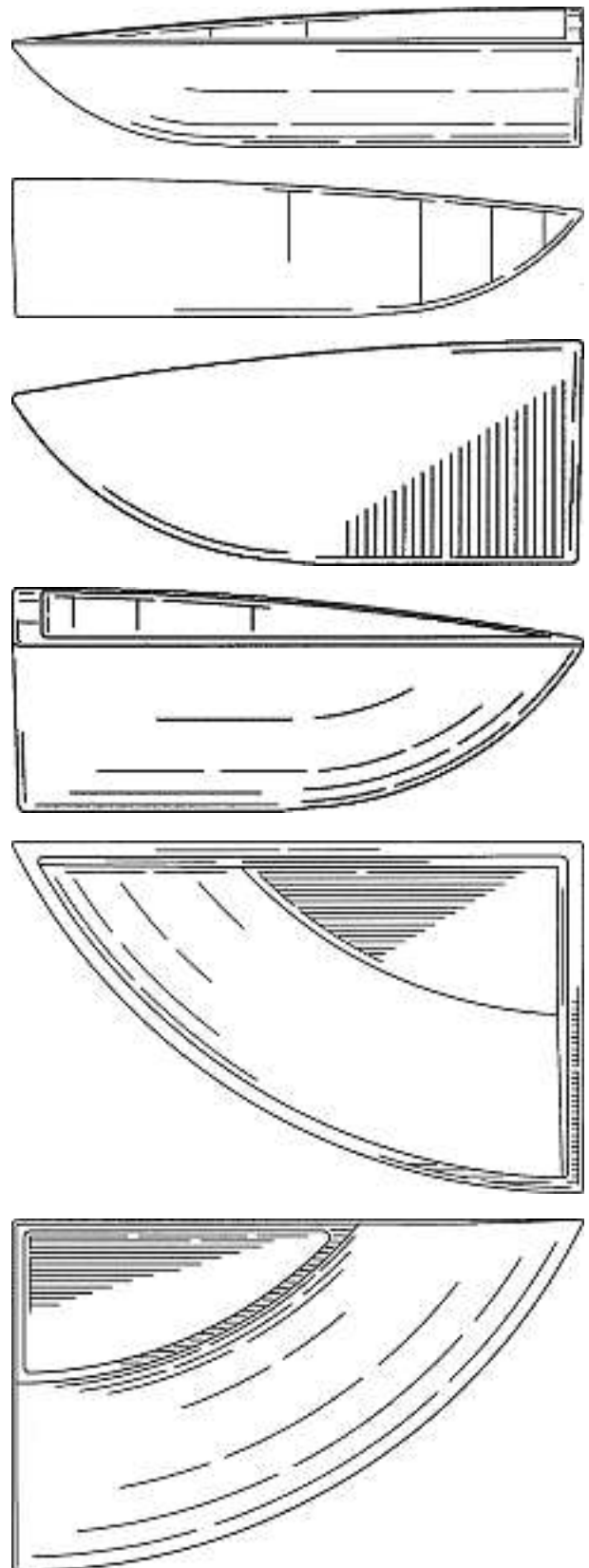
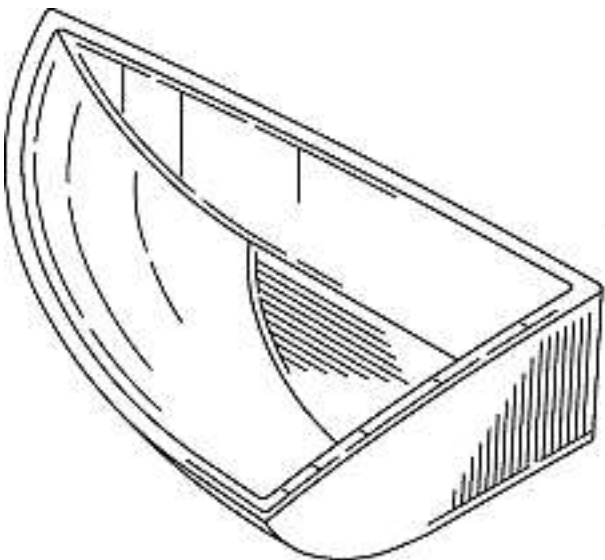

D. 16/2004-2

Cl. 07-01, 07-06 **130 622** 22.04.2004  
 5 Design – Teekanne, Salzstreuer, Pfefferstreuer, Teller,  
 Schüssel  
 Hinterleger: Pi-Design AG, Kantonsstrasse 100,  
 6234 Triengen  
 Designer: Jorgen Bodum, St. Niklausen  
 Vertreter: A.W. Metz & Co. AG, 8024 Zürich  
 Priorität: DK, 11.11.2003





1





2





3

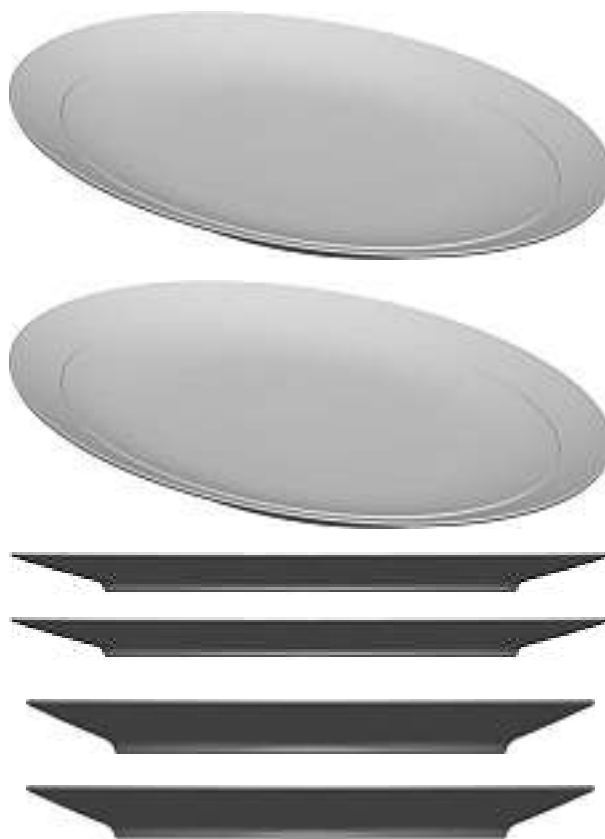



4







5

Cl. 07-02                      **130 623**                      12.04.2004  
 3 Design – Grillspiess  
 Hinterleger: Sonderegger Schlosserei + Metallbau AG,  
 Egnacherstrasse 53, 9320 Frasnacht  
 Designer: Thomas Sonderegger, Frasnacht

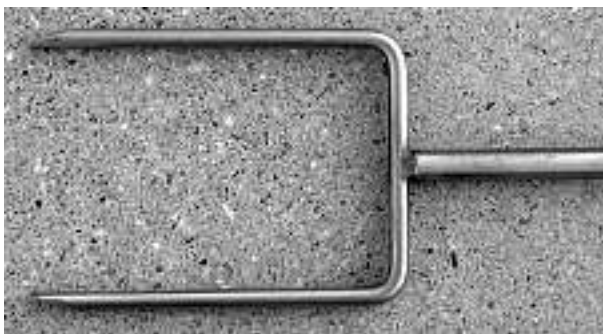

2 Zack

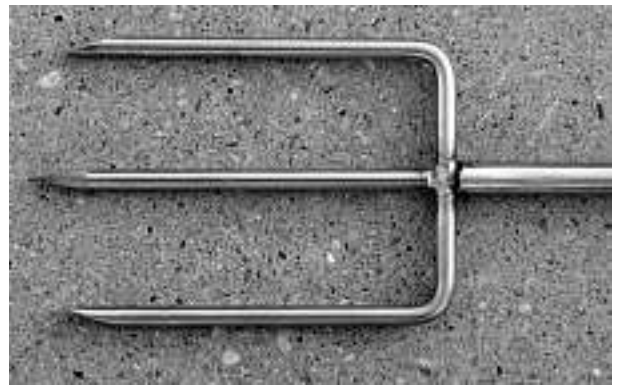

3 Zack

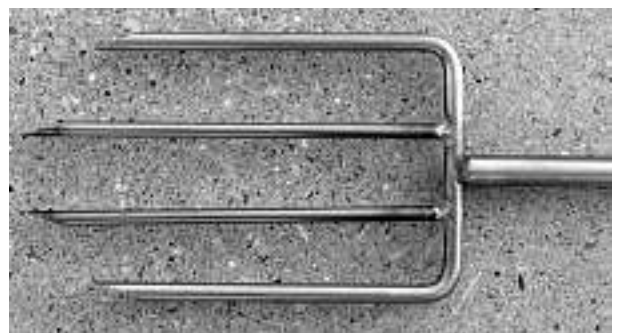

4 Zack

Cl. 07-06                      **130 624**                      14.05.2004  
 1 Design – Flüssigkeitsdispenser  
 Hinterleger: Pi-Design AG, Kantonsstrasse 100,  
 6234 Triengen  
 Designer: Jorgen Bodum, St. Niklausen  
 Vertreter: A.W. Metz & Co. AG, 8024 Zürich  
 Priorität: DK, 18.12.2003





52533-CH-7-DC

Cl. 08-99 **130 625** 05.04.2004  
 1 Design – Tasterfassung  
 Hinterleger: ISELI DESIGN & Partner AG,  
 Weyermannsstrasse 28, 3008 Bern  
 Designer: Martin Iseli, Bern



Tasterfassung

Cl. 10-02 **130 626** 06.04.2004  
 1 design – montre-bracelet  
 Déposant: MDM SA, Genève, 7, rue de la Fontaine,  
 1204 Genève  
 Designer: Carlo Crocco, Lugano  
 Mandataire: INFOSUISSE Information Horlogère et  
 Industrielle, 2300 La Chaux-de-Fonds



Subaquaneus 01

Cl. 10-02 **130 627** 07.04.2004  
 1 design – montre-bracelet  
 Déposant: Eterna SA, Fabrique d'Horlogerie,  
 Schützengasse 46, 2540 Grenchen  
 Designer: Ernst F. Seyr, Bettlach  
 Mandataire: Soprintel S.A., 2300 La Chaux-de-Fonds



Indicator

Cl. 10-02 130 628 13.04.2004  
2 Design – Armbanduhren  
Hinterleger: Lukas Wullimann, St. Margrithenstrasse 10,  
4500 Solothurn



01



02

Cl. 10-02, 10-07 130 629 14.04.2004  
 10 design – boîtiers de montre, montres-bracelet  
 Déposant: de Grisogono S.A., 176bis, Route de Saint-Julien,  
 1228 Plan-les-Ouates  
 Designer: Fawaz Gruosi, Prangins  
 Mandataire: Griffes Consulting S.A., 1206 Genève

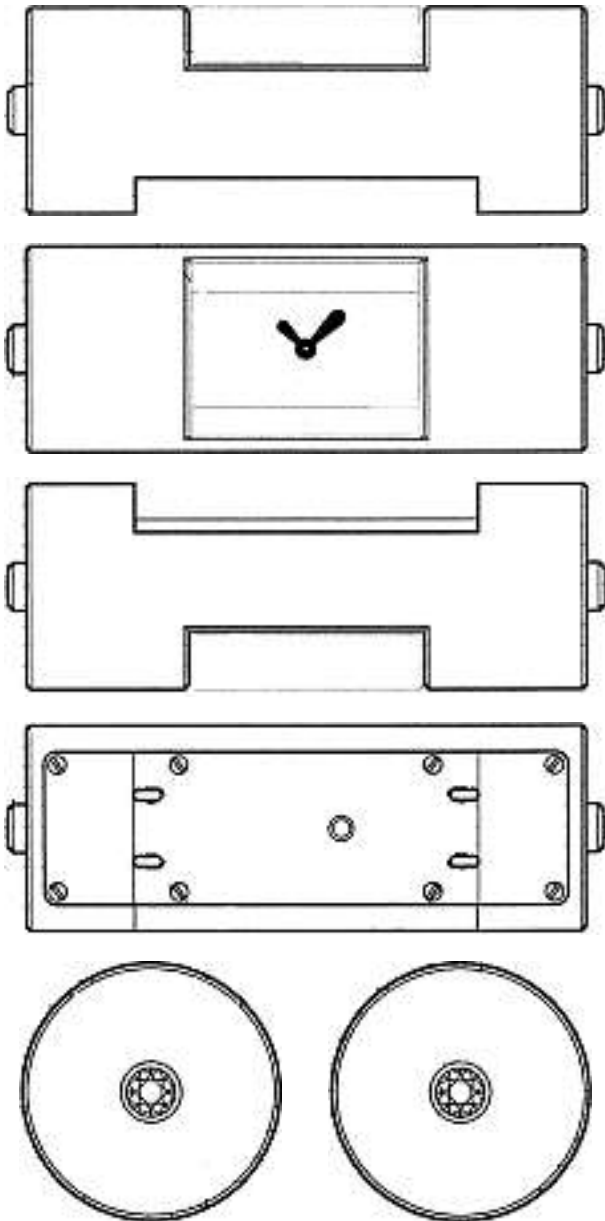

MO-28714-CH



MO-28715-CH



MO-28716-CH



MO-28717-CH





MO-28718-CH

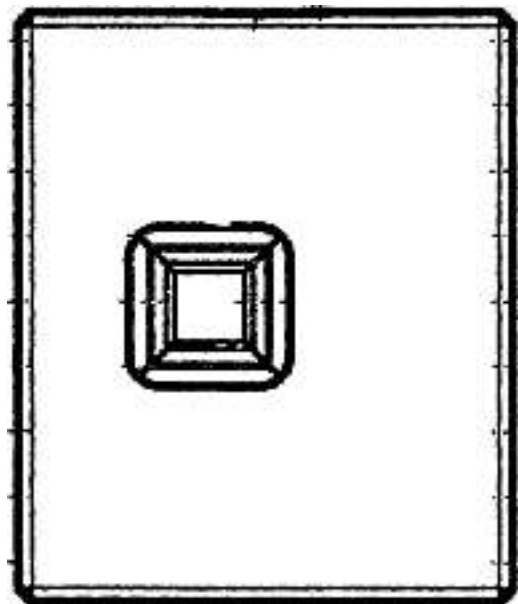
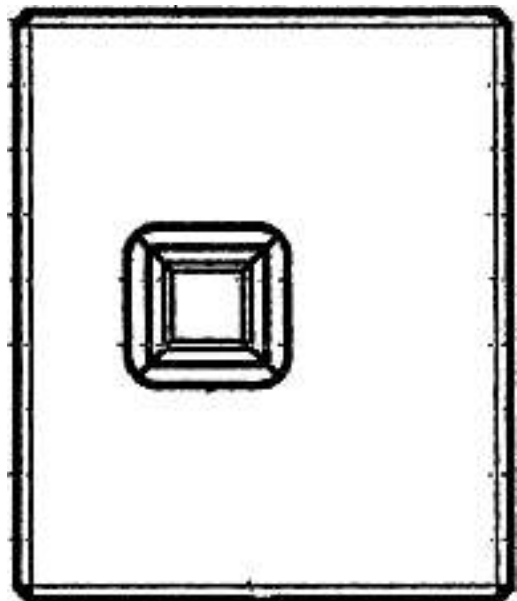
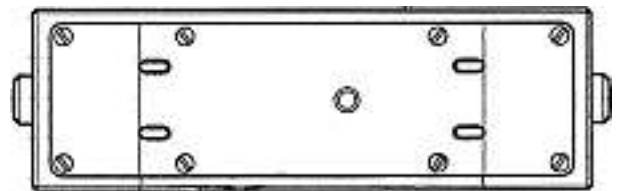

MO-28719-CH

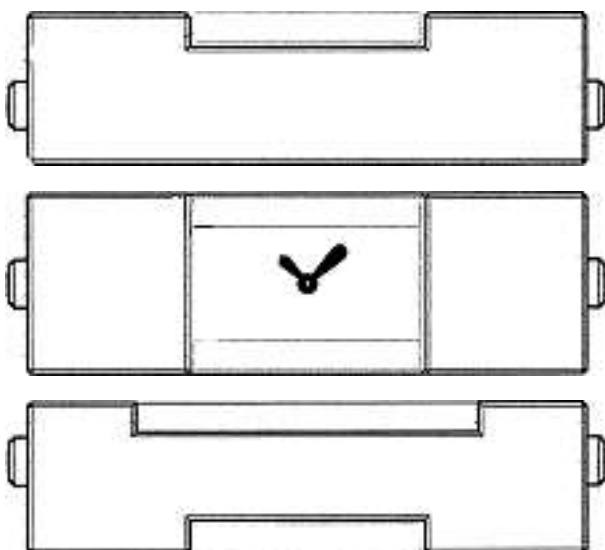

MO-28720-CH

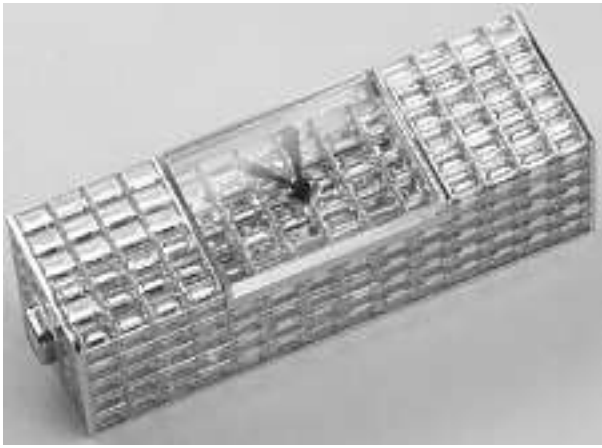

MO-28721-CH

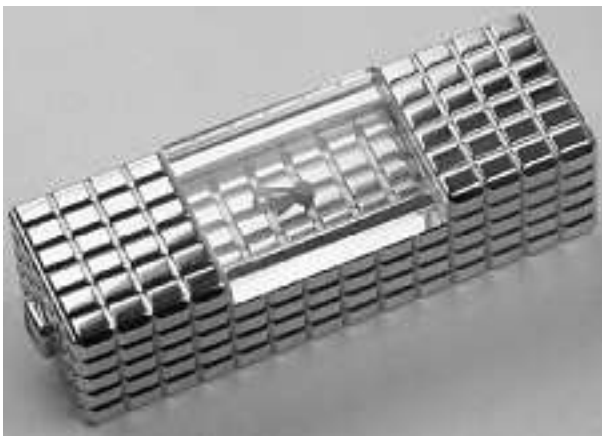

MO-28722-CH

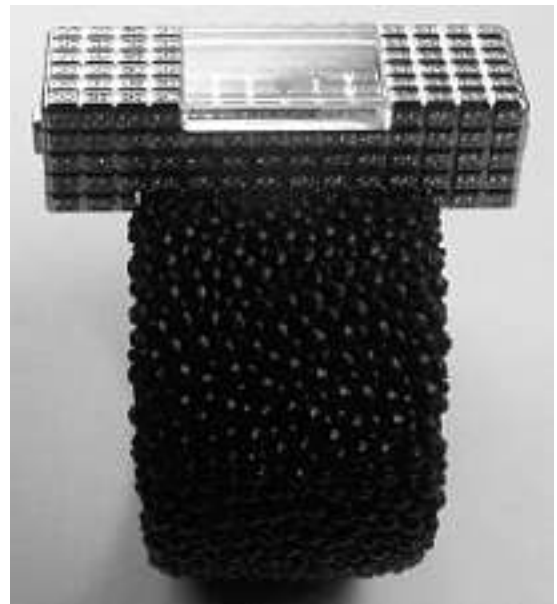

MO-28723-CH

Cl. 10-07 130 632 31.03.2004  
 1 Design – Zifferblatt  
 Hinterleger: Andreas Mossner, Kettberg 28, 8049 Zürich

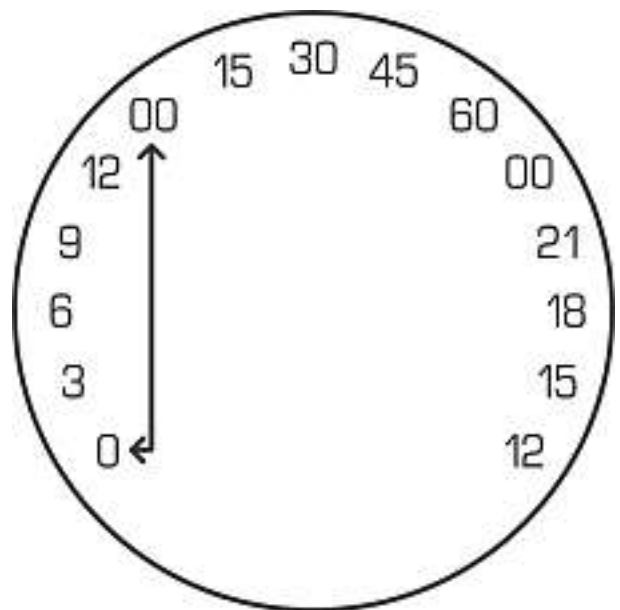

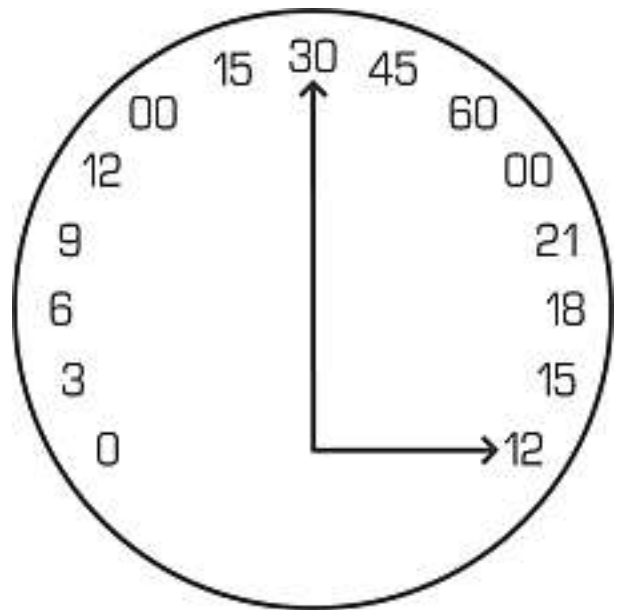
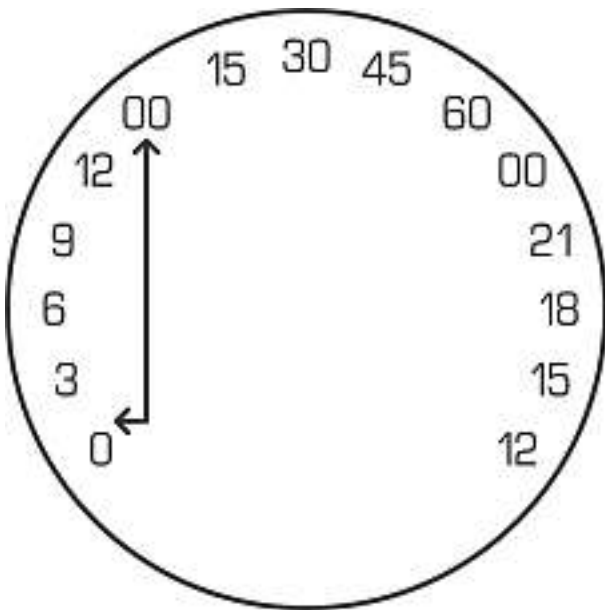
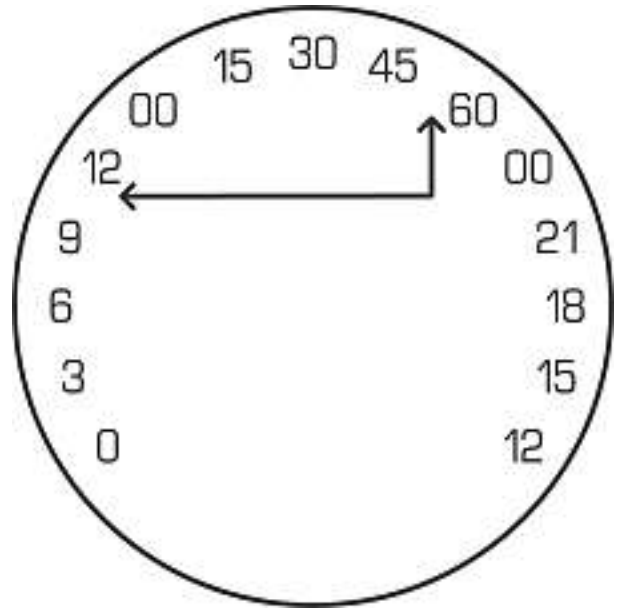
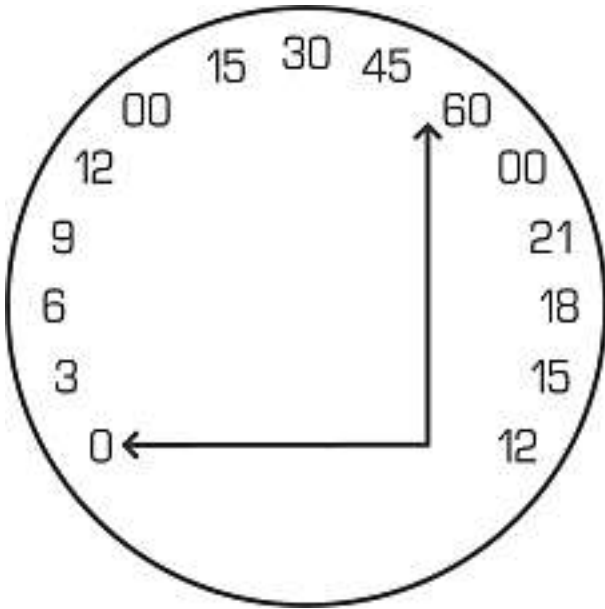
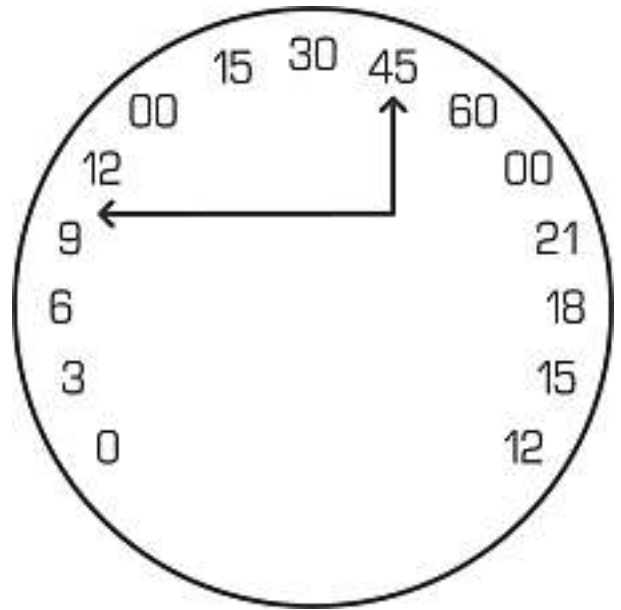
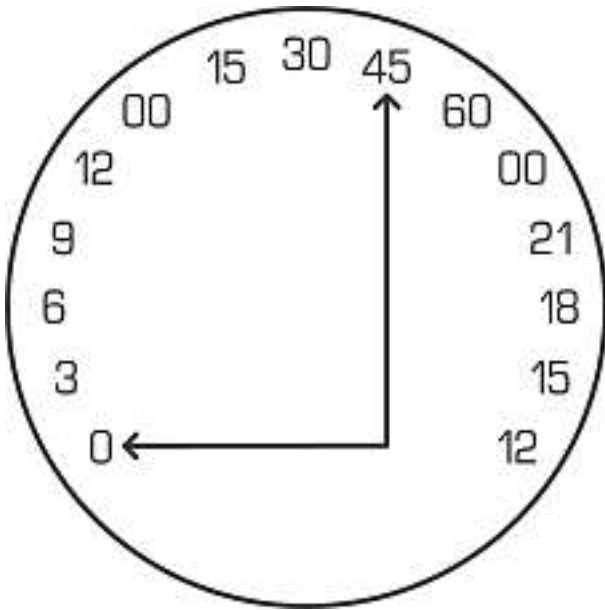



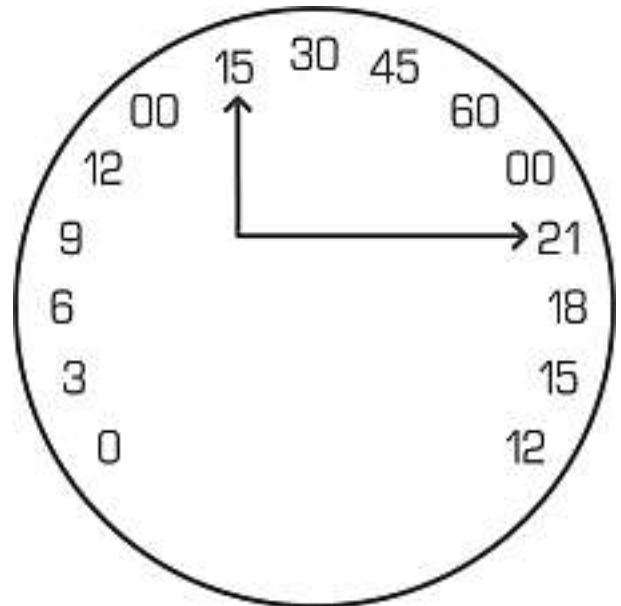
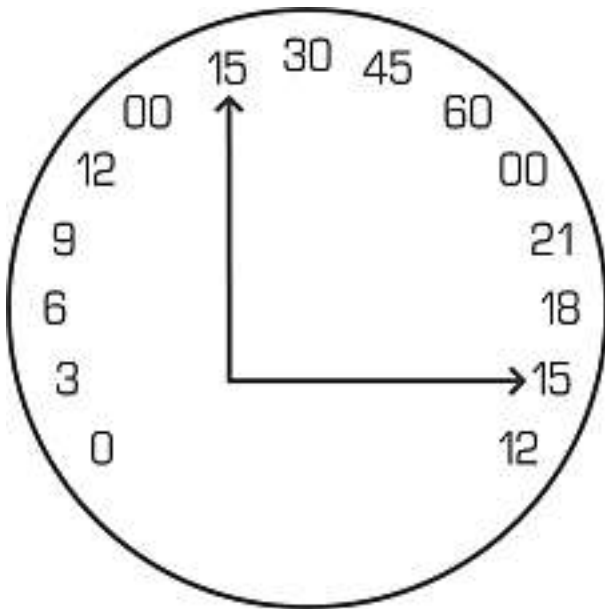
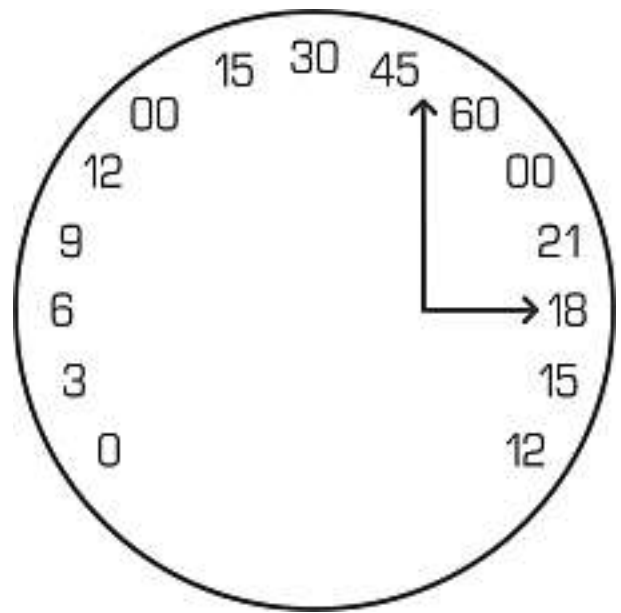
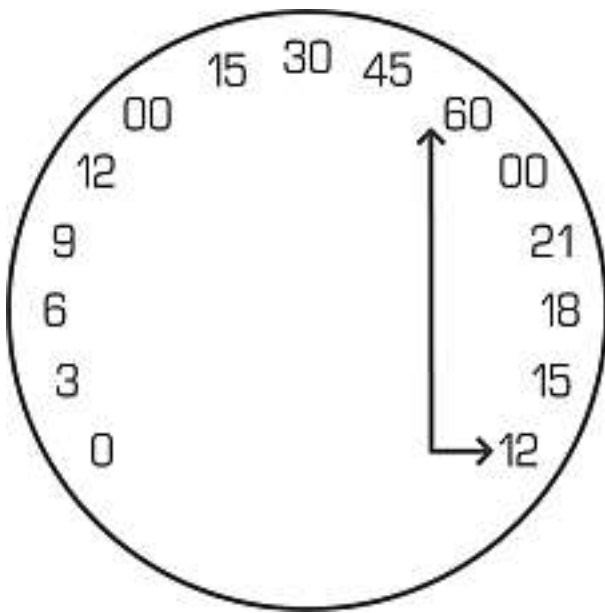

Angletime

Cl. 10-07

130 633

31.03.2004

1 Design – Zifferblatt

Hinterleger: Andreas Mossner, Kettberg 28, 8049 Zürich

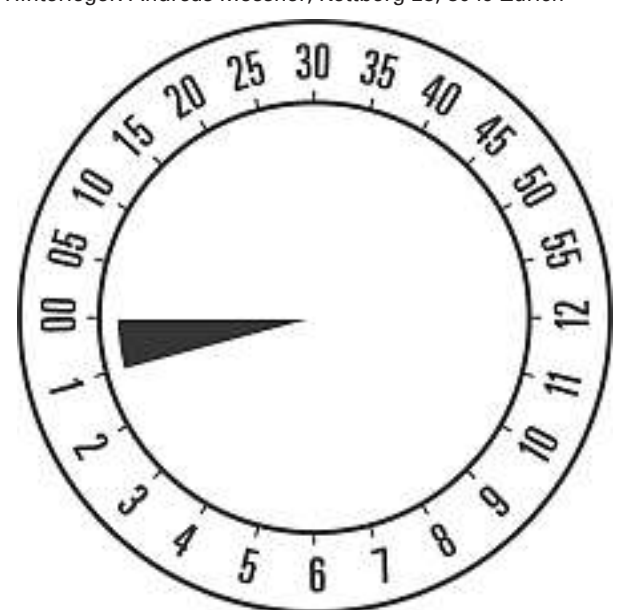
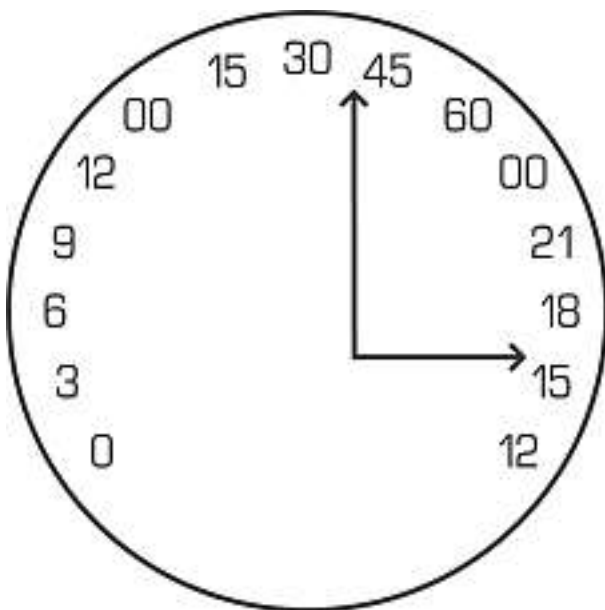

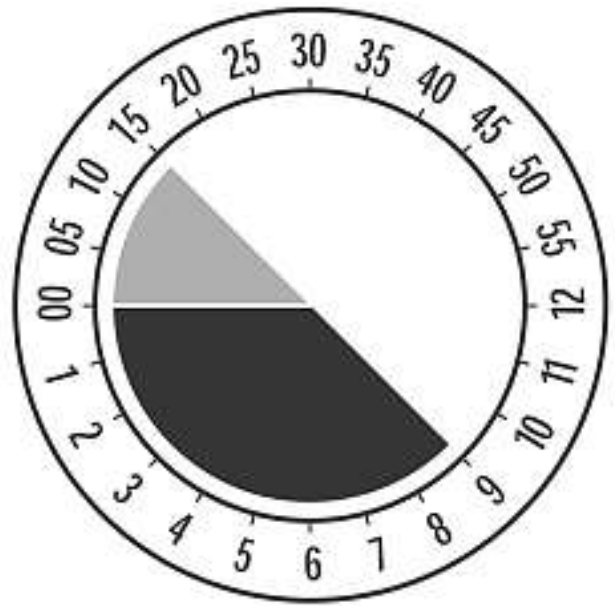
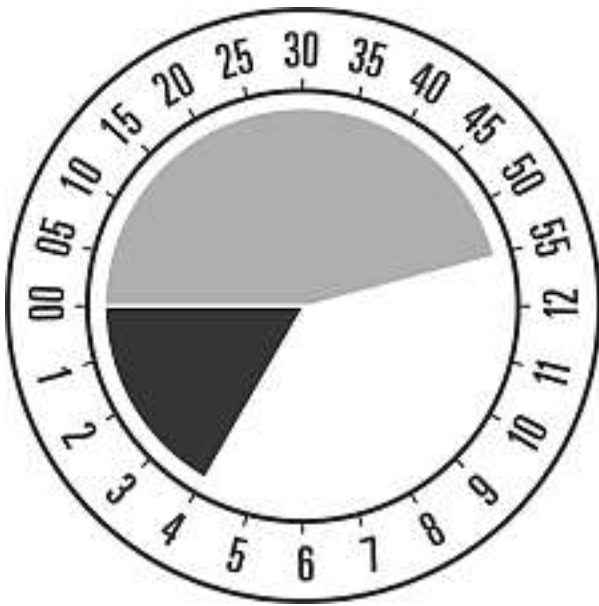
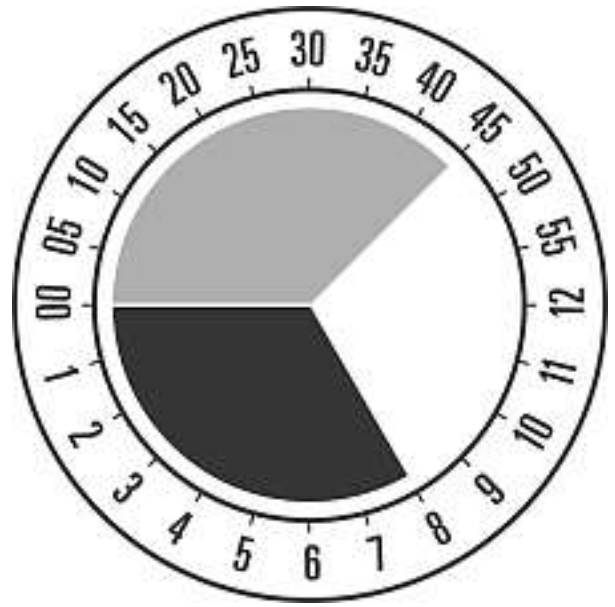
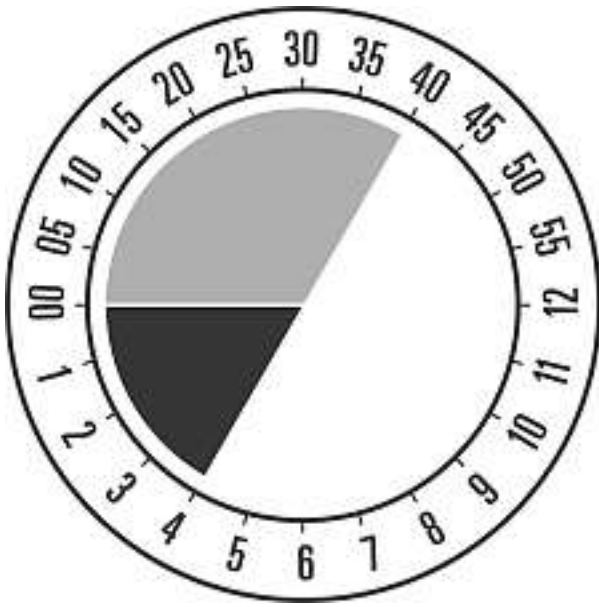
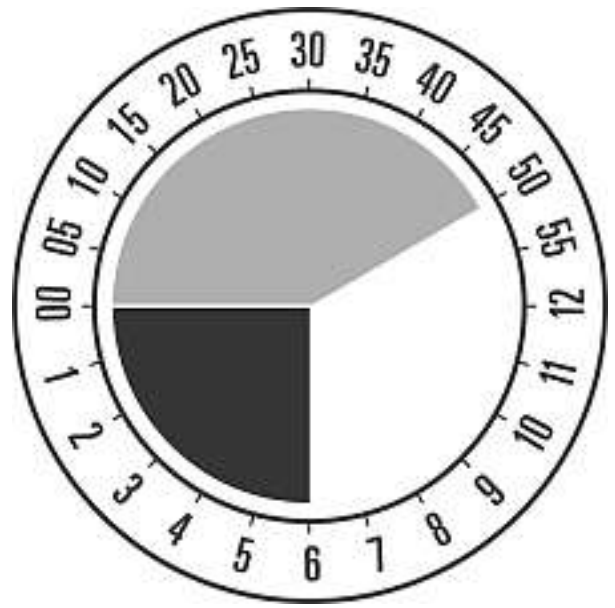
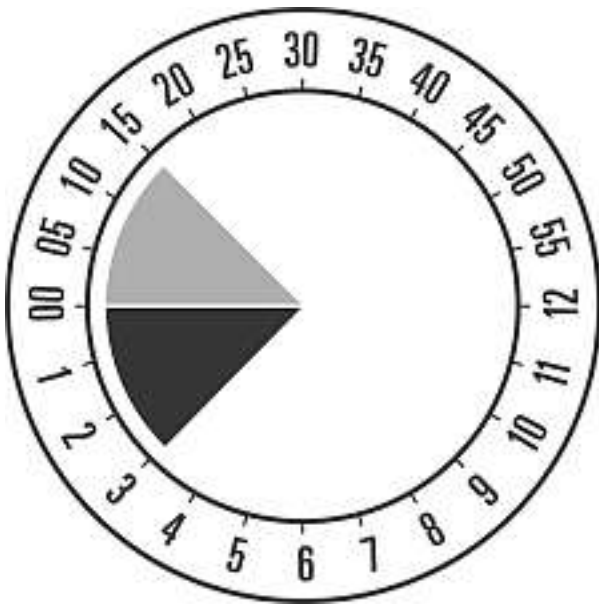

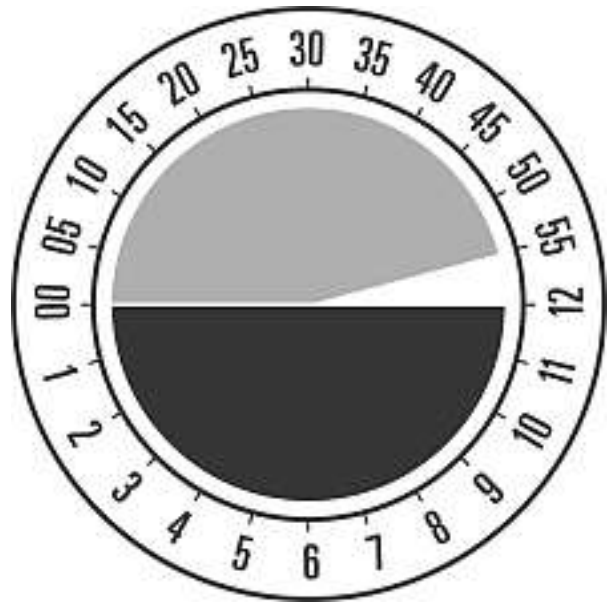
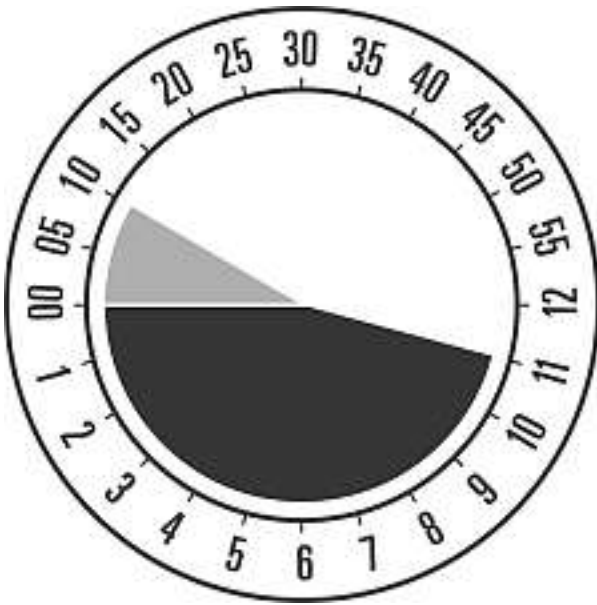
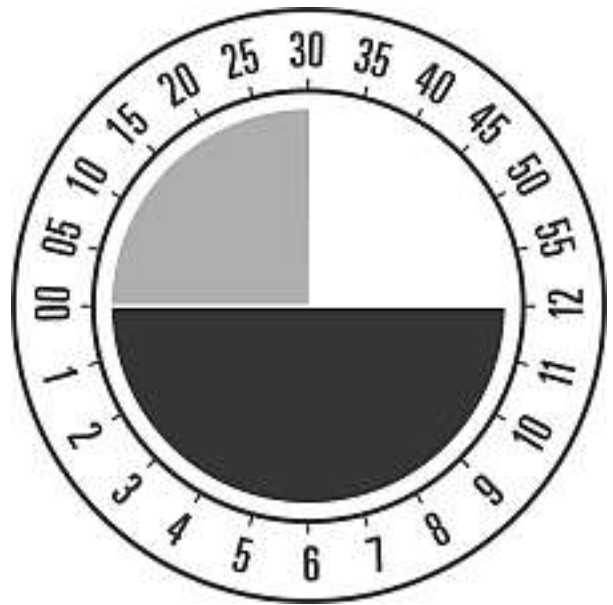
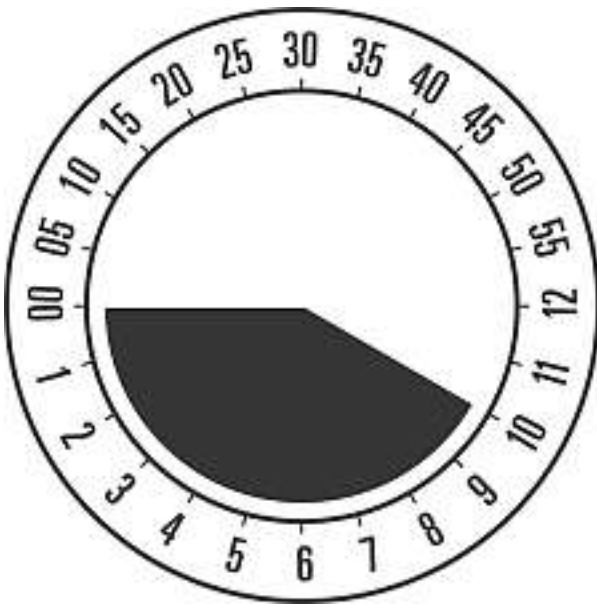

Halftime

Cl. 10-07

130 634

31.03.2004

1 Design – Zifferblatt

Hinterleger: Andreas Mossner, Kettberg 28, 8049 Zürich

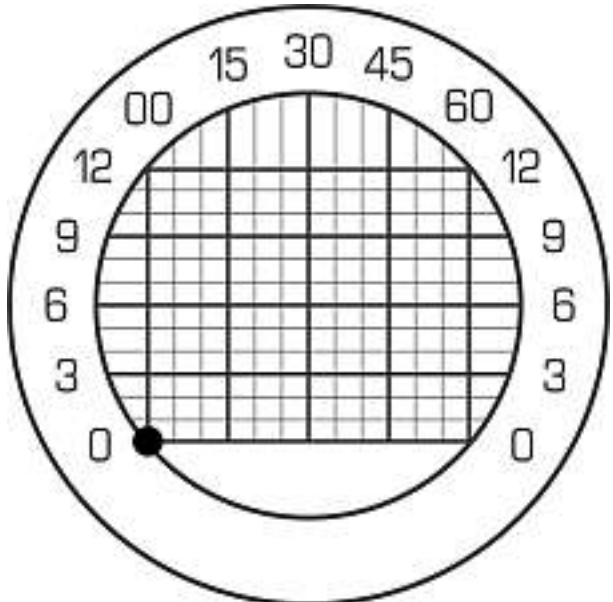

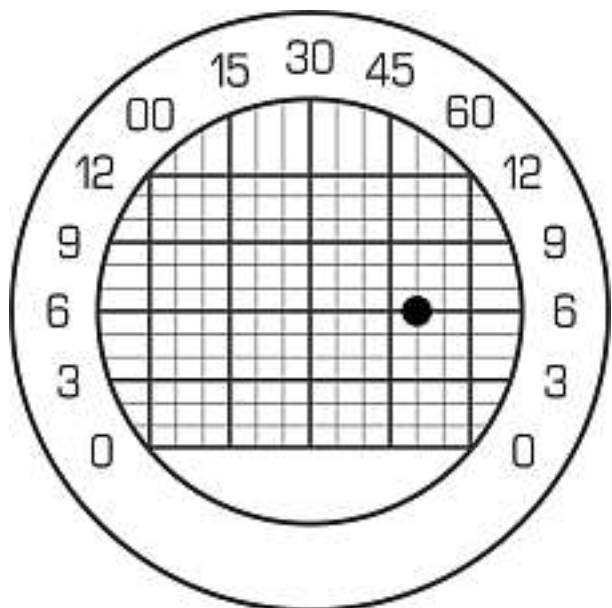
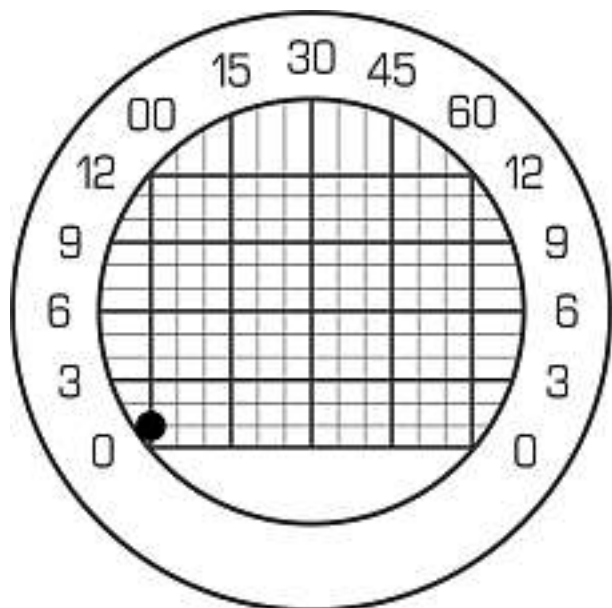
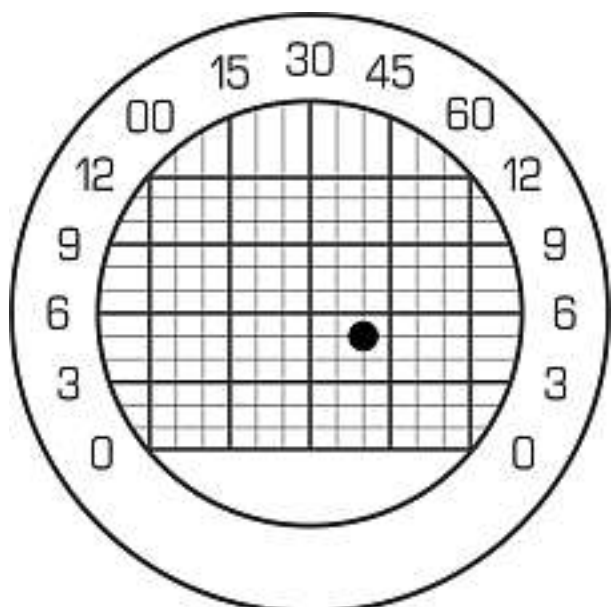
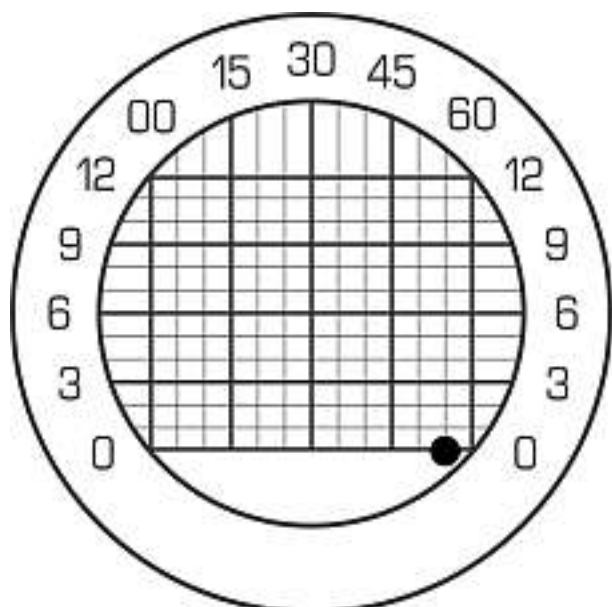
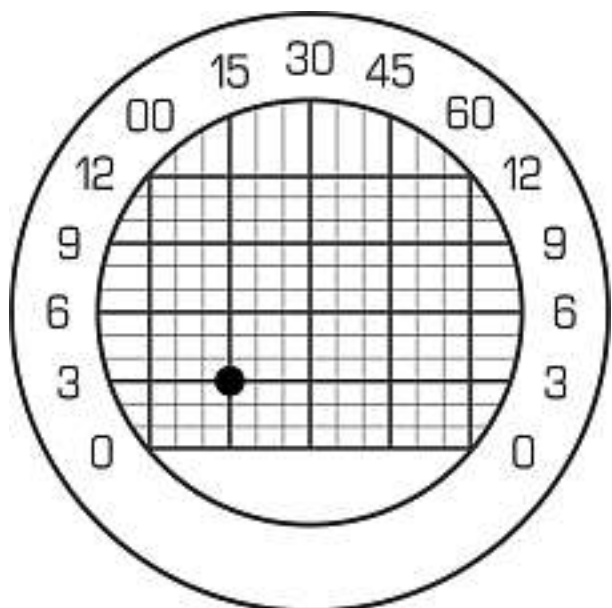
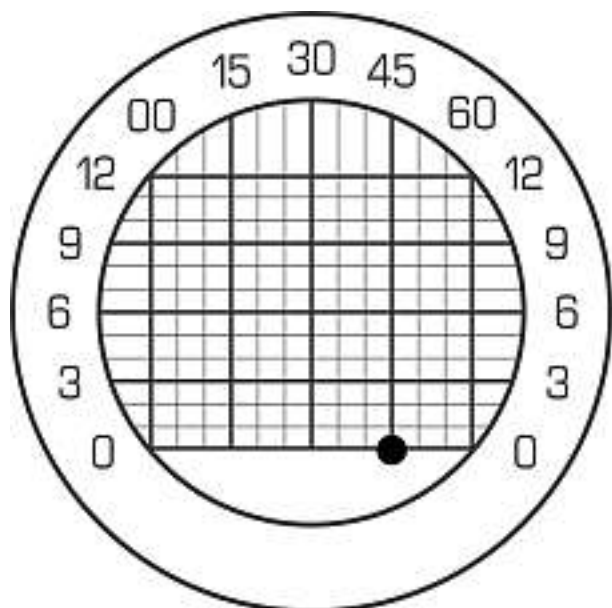

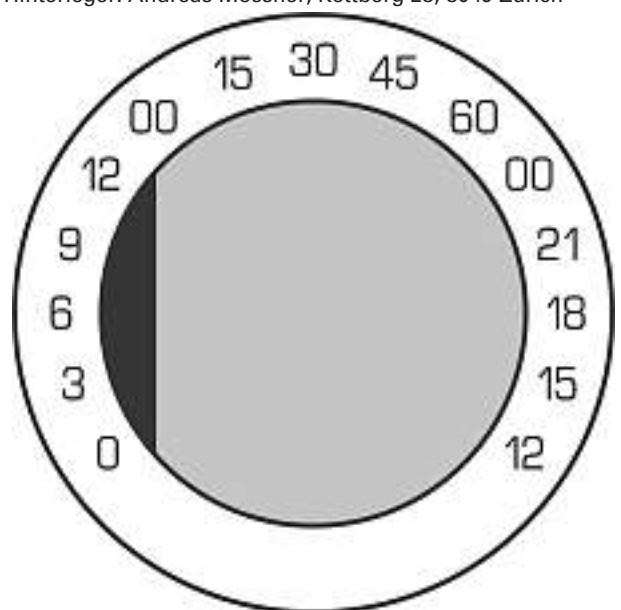
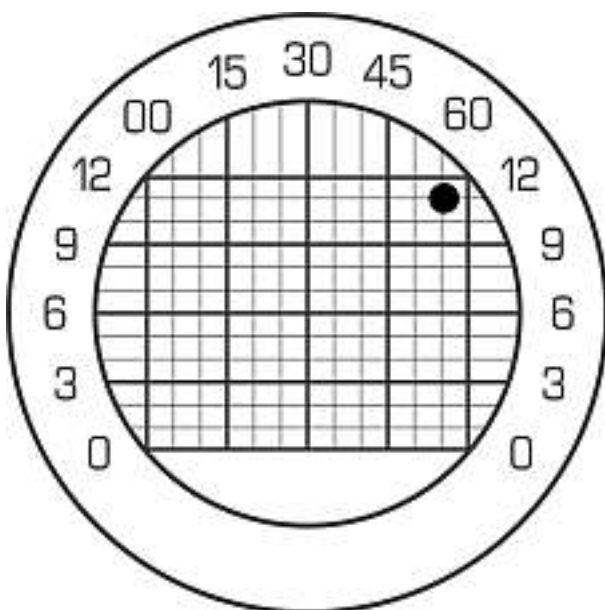
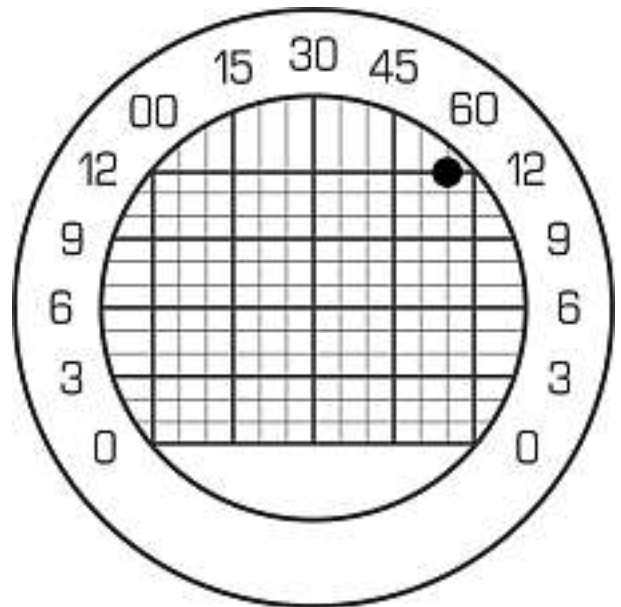
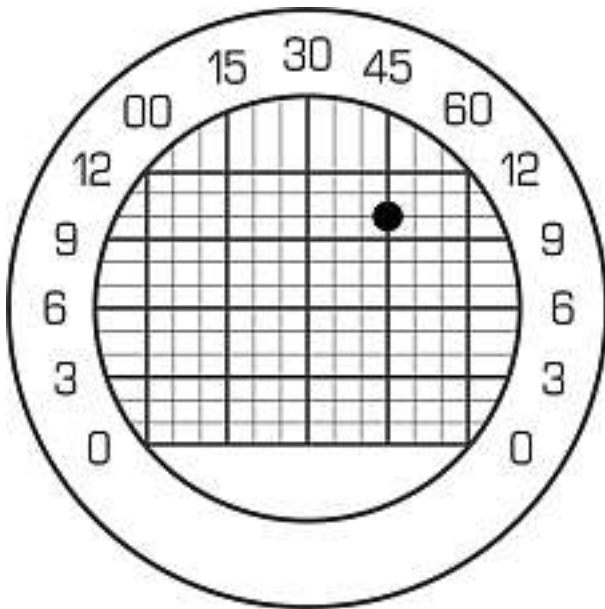
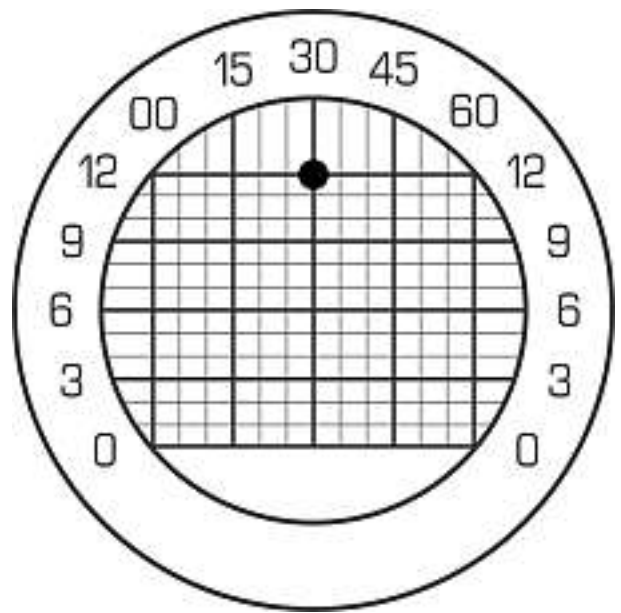
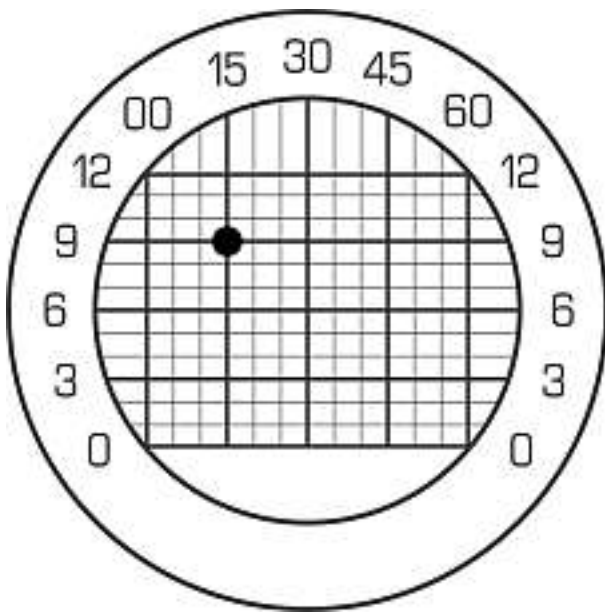

Netime

Cl. 10-07

130 635

31.03.2004

1 Design – Zifferblatt

Hinterleger: Andreas Mossner, Kettberg 28, 8049 Zürich

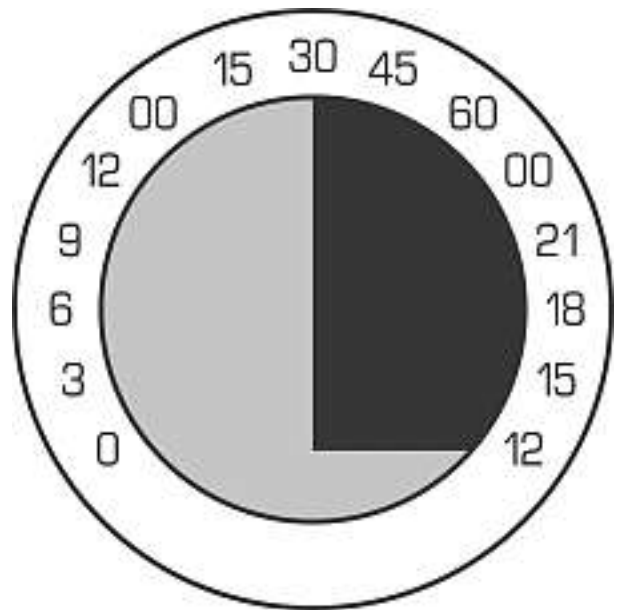
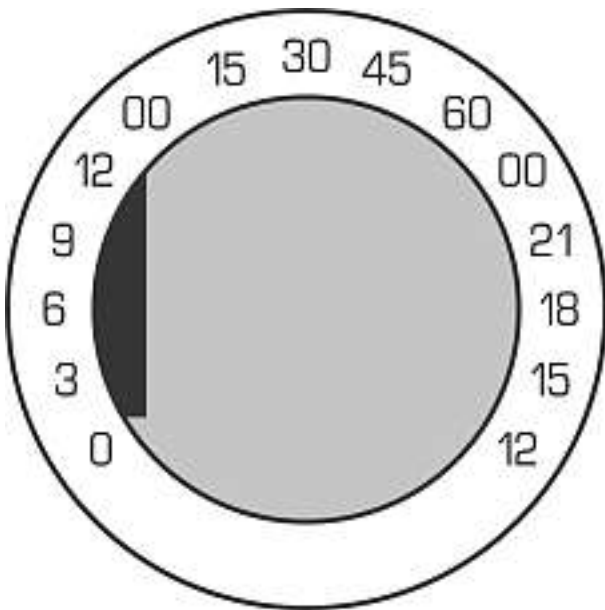
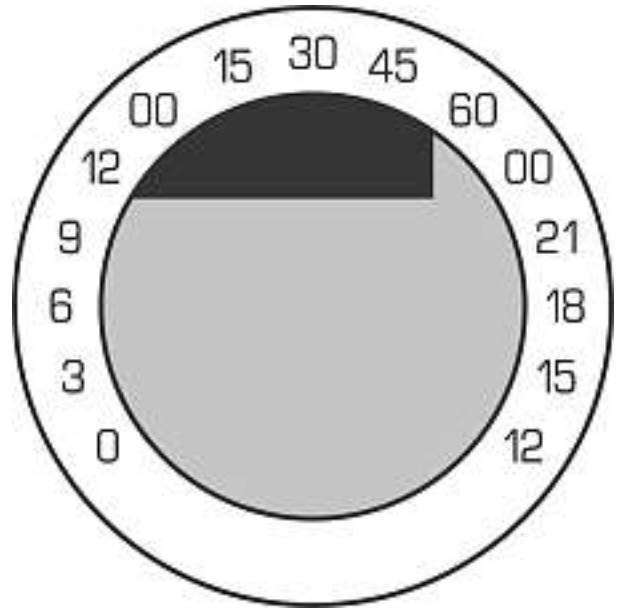
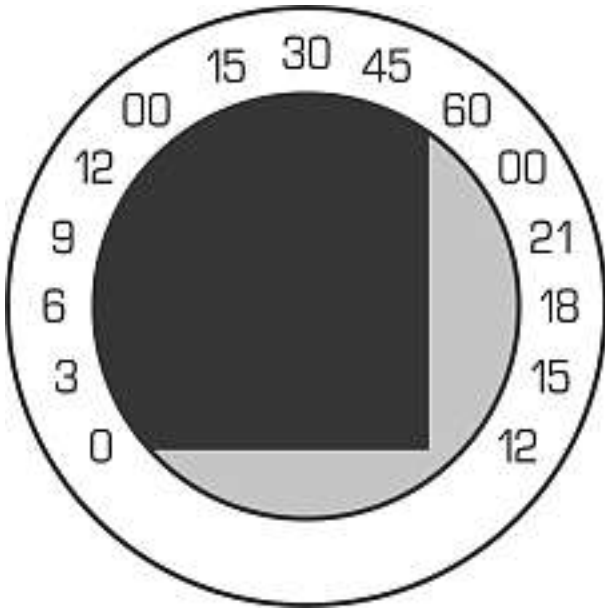
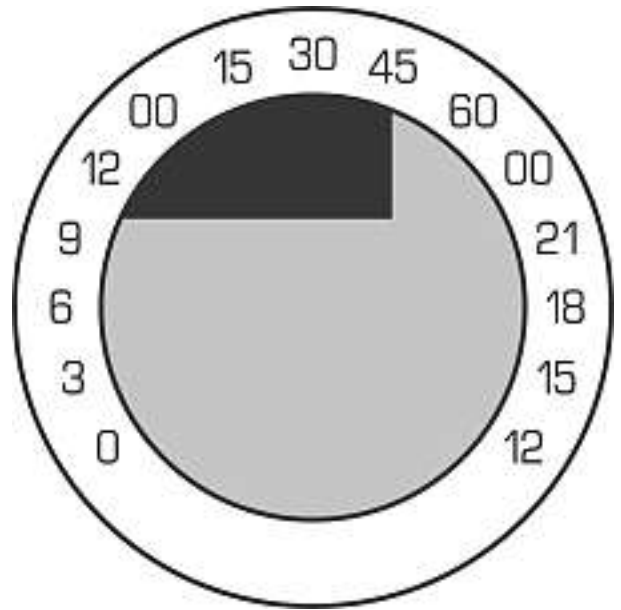
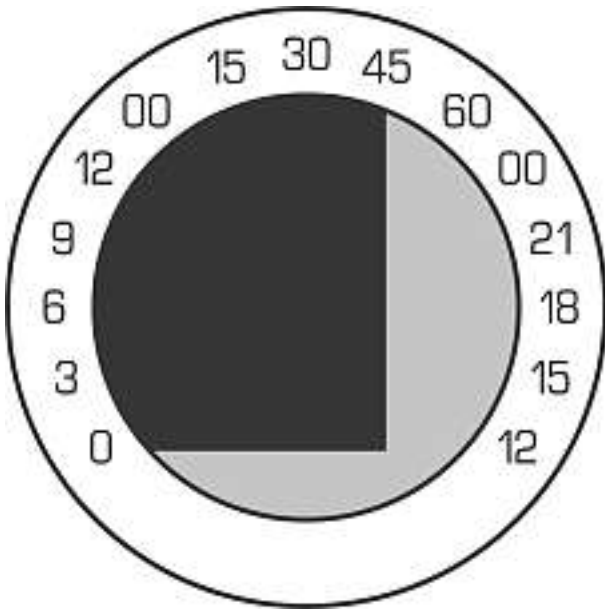

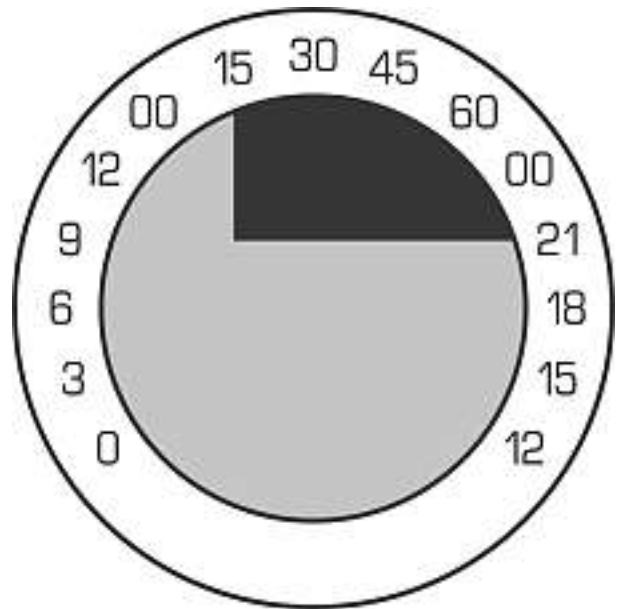
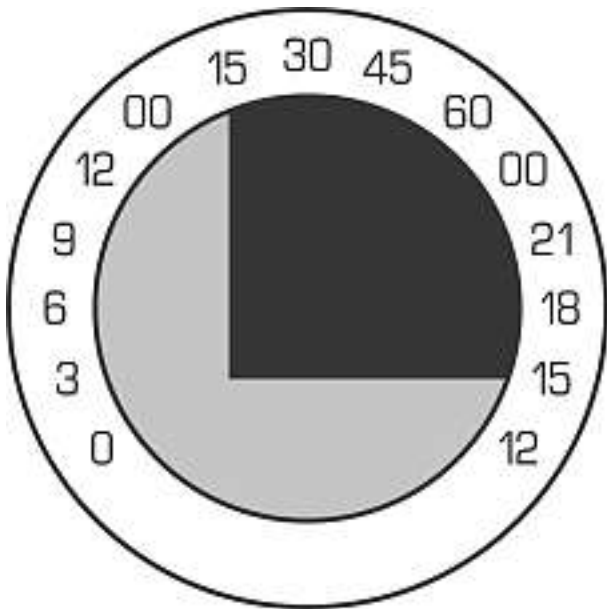
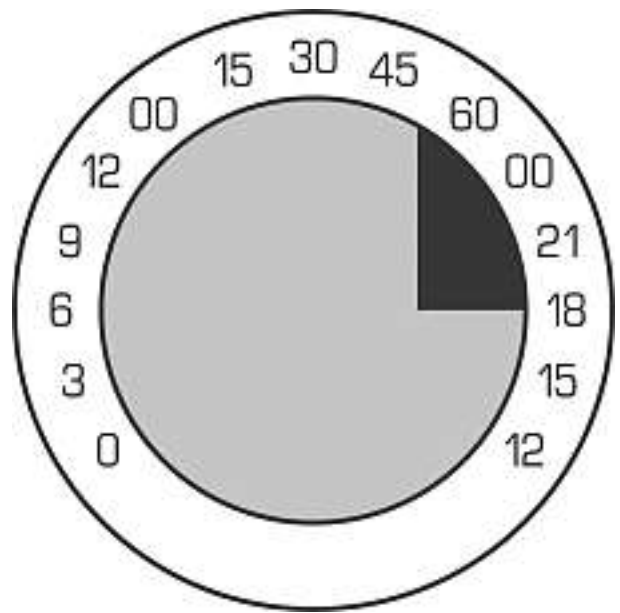
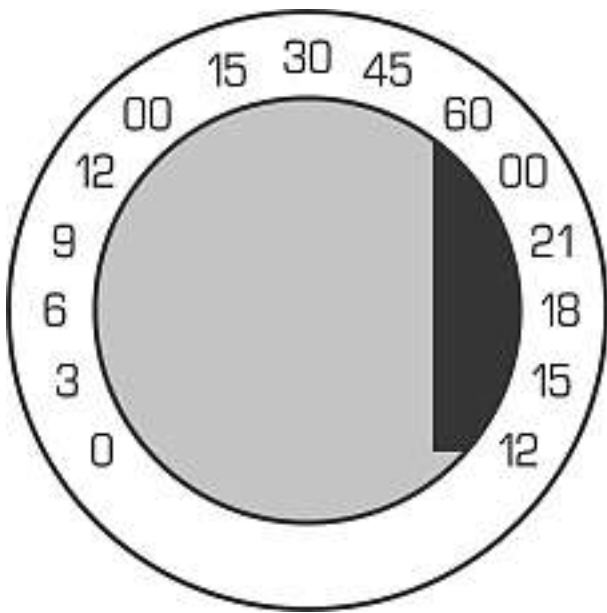

Partime

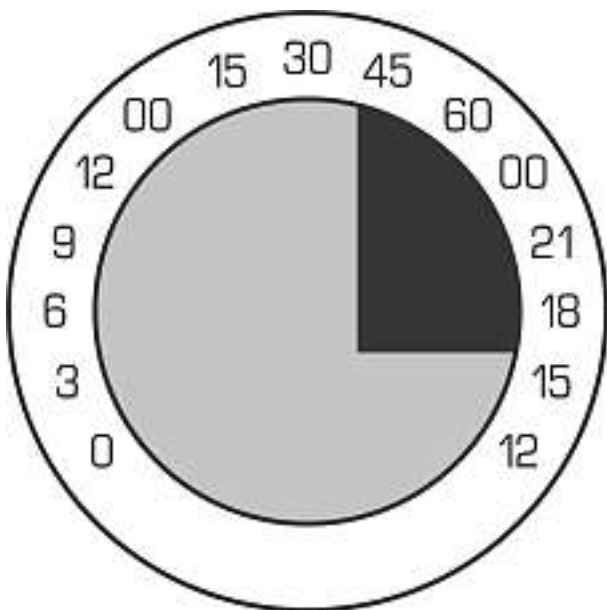

Cl. 11-01 **130 636** 07.04.2004  
 5 design – bague, élément décoratif pour bijoux, pendentif,  
 boucles d'oreilles, bracelet  
 Déposant: Ludovic Lesemann Genève Sàrl., Avenue Krieg 7,  
 1208 Genève  
 Designer: Ludovic Lesemann, Genève  
 Mandataire: Griffes Consulting S.A., 1206 Genève

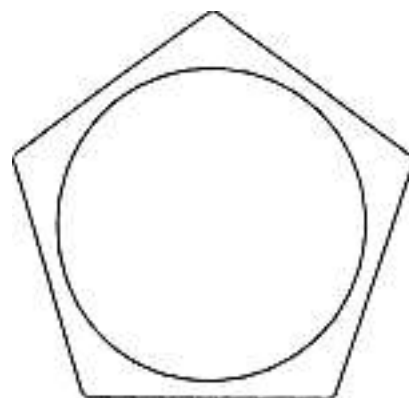

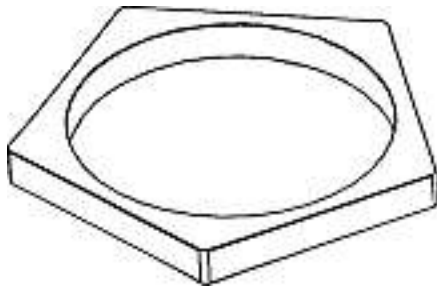
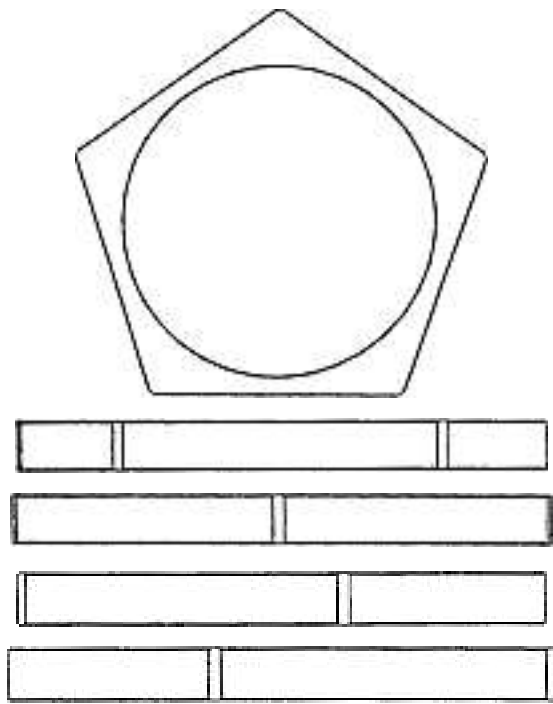

1

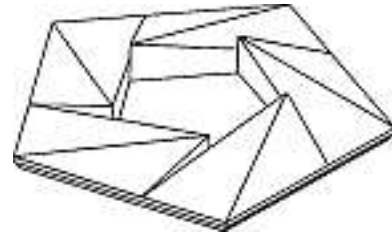
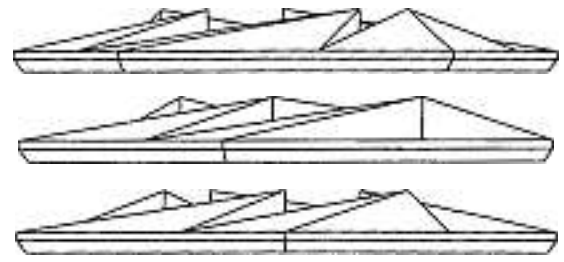
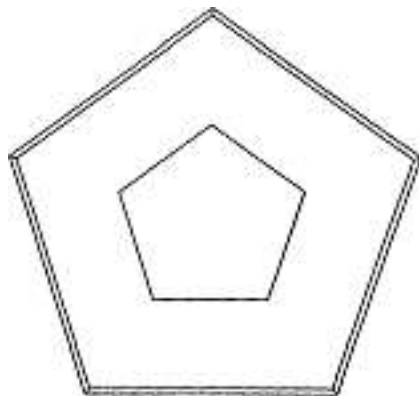
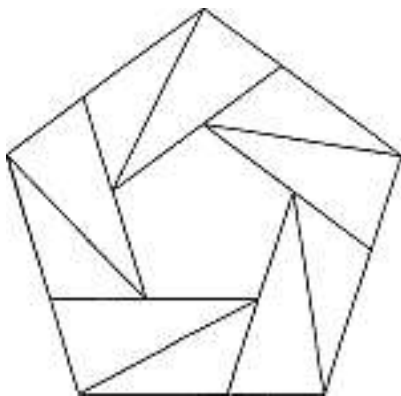

2



3





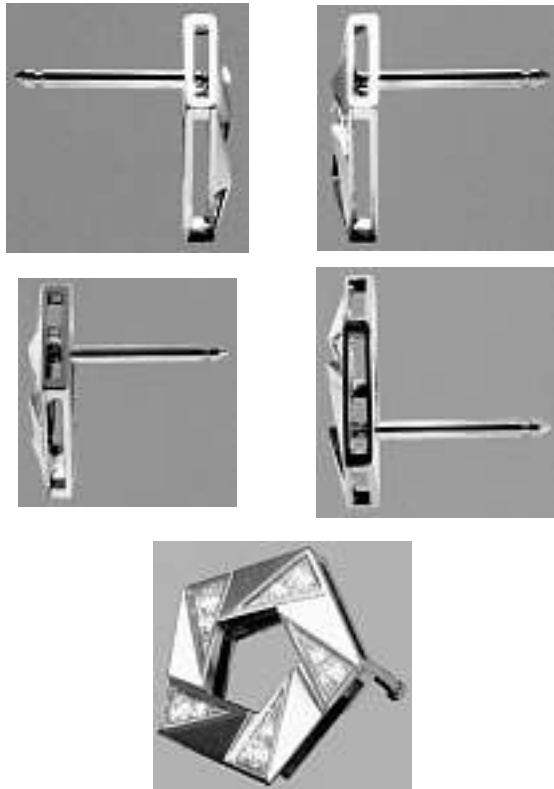

4

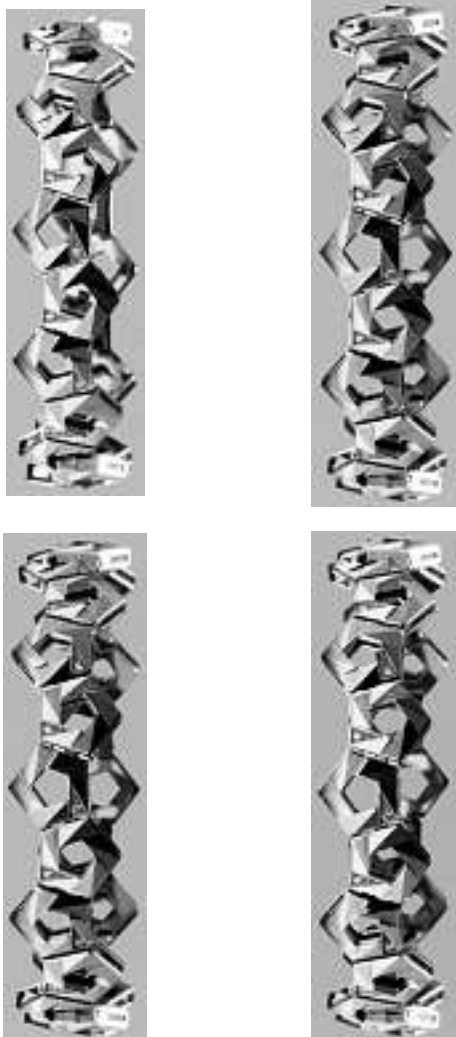

5

Cl. 11-01 **130 637** 13.04.2004  
 14 design – bagues, pendentifs, boucles d'oreilles, collier  
 Déposant: Mauboussin S.A., 20, place Vendôme, Paris, FR  
 Designer: Alain Nemaq, Paris  
 Mandataire: Griffes Consulting S.A., 1206 Genève



MO-51618-CH



MO-51617-CH





MO-51619-CH



MO-51620-CH





MO-51621-CH



MO-51622-CH



MO-51623-CH



MO-51624-CH



MO-51625-CH



MO-51626-CH



MO-51627-CH





MO-51628-CH



MO-51629-CH



MO-51630-CH

Cl. 12-05 130 639 18.02.2004  
1 Design – Lift  
Hinterleger: STUDER & STUDER Hebebühnen GmbH, SSH,  
Zelgstrasse 7, 8280 Kreuzlingen  
Designer: Philipp Studer, Kreuzlingen

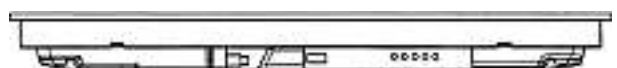
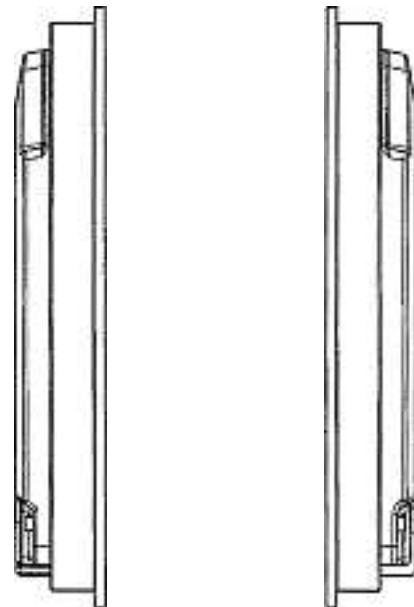
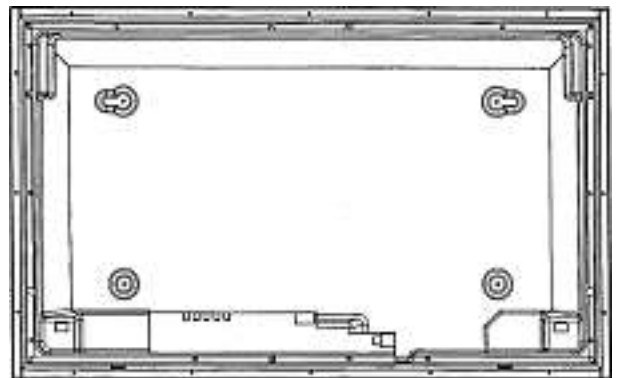
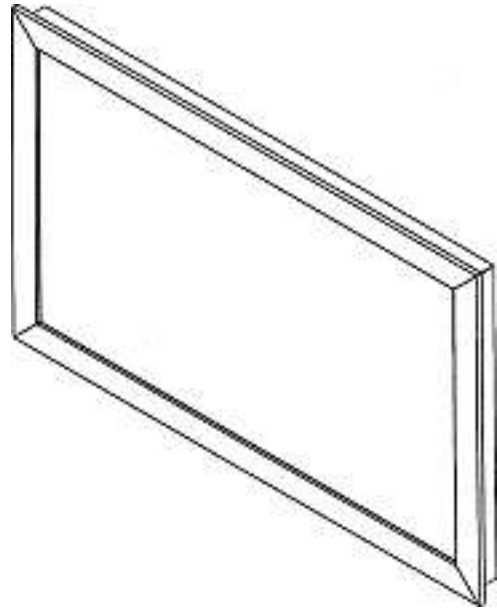

2003.312

Cl. 14-03                      **130 640**                      13.02.2004  
 1 Design – Plasmabildschirm  
 Hinterleger: Bang & Olufsen A/S, Peter Bangs Vej 15,  
 7600 Struer, DK  
 Designer: David Lewis, Kopenhagen  
 Vertreter: A.W. Metz & Co. AG, 8024 Zürich  
 Priorität: DK, 25.11.2003

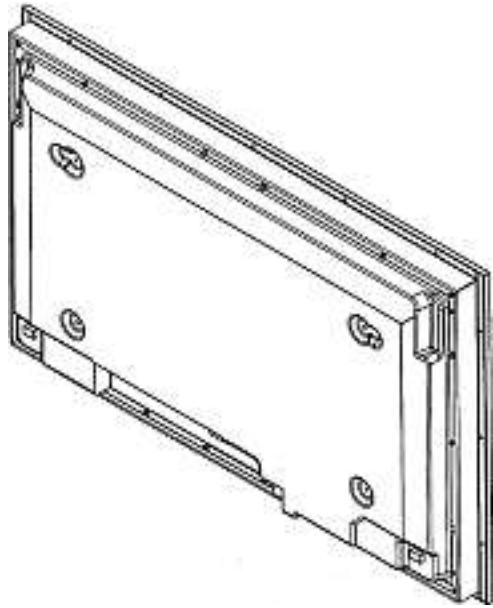

1763-CH-14

Cl. 15-06                      **130 641**                      05.04.2004  
 2 Design – Maschinenverkleidung  
 Hinterleger: Trützschler GmbH & Co. KG, Duvenstrasse 82-92,  
 41199 Mönchengladbach, DE  
 Designer: Rino Bossy, Wülfrath; Armin Leder,  
 Mönchengladbach  
 Vertreter: A. Braun, Braun, Héritier, Eschmann AG,  
 Patentanwälte, 4051 Basel  
 Priorität: DE, 09.10.2003

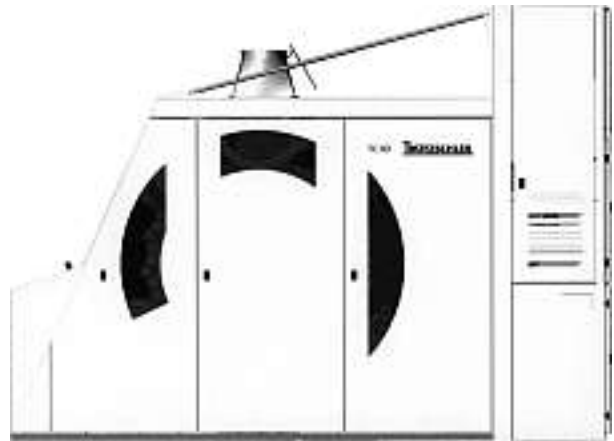
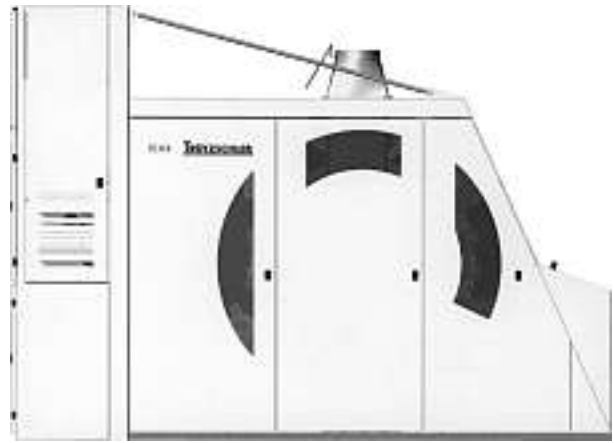

1





2

Cl. 15-06                      **130 642**                      05.04.2004  
 2 Design – Maschinenverkleidung  
 Hinterleger: Trützschler GmbH & Co. KG, Duvenstrasse 82-92,  
 41199 Mönchengladbach, DE  
 Designer: Rino Bossy, Wülfrath; Armin Leder,  
 Mönchengladbach  
 Vertreter: A. Braun, Braun, Héritier, Eschmann AG,  
 Patentanwälte, 4051 Basel  
 Priorität: DE, 09.10.2003

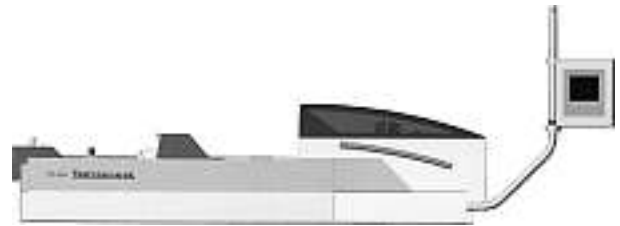
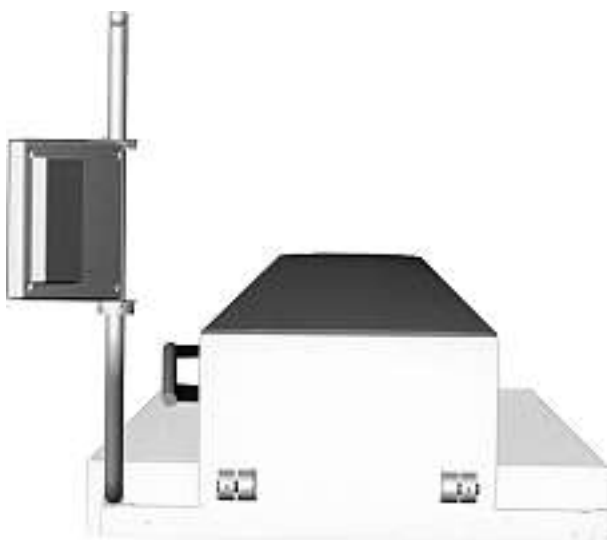

1

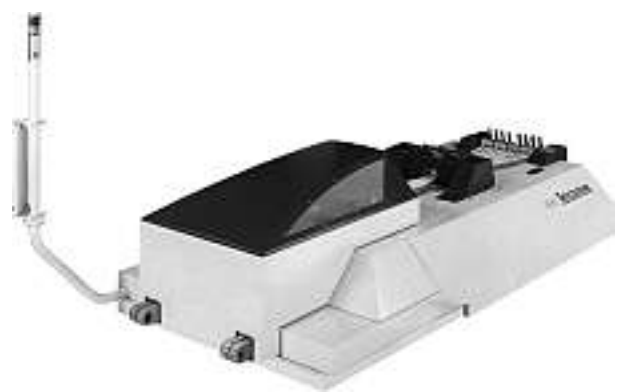
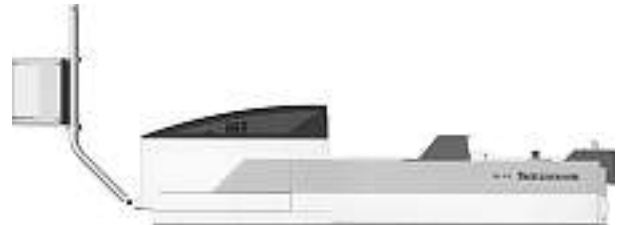

2

Cl. 16-06                      **130 643**                      02.04.2004  
 2 Design – Brillenhalterung  
 Hinterleger: Max Selinger, Limmatauweg 5, 5408 Ennetbaden

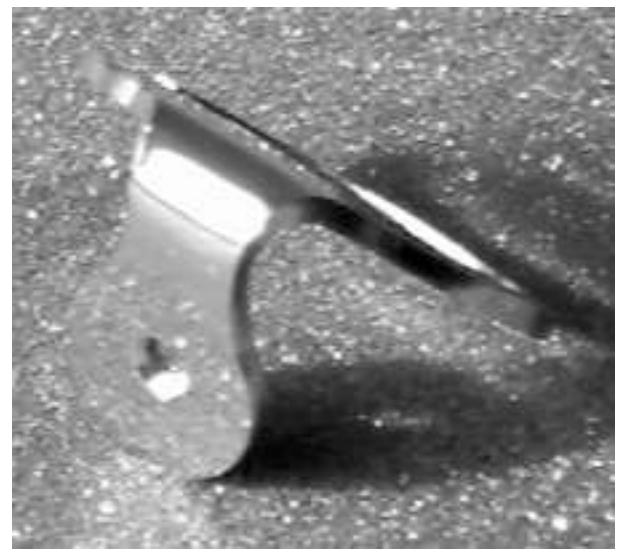



GOB 2004



GOB 2005

Cl. 19-08 130 645 02.04.2004  
 5 Design – Etiketten  
 Hinterleger: Cave Fin Bec SA, Case postale 137,  
 1964 Conthey 1  
 Designer: Nino Botarelli, Iseo; Gérald de Palézieux, Veyras



Fliegende Ente



Verschneite Landschaft



Trauben



Meeres  
Horizont



Möwe

Cl. 19-99 **130 646** 01.04.2004  
 1 Design – Rechenschieber  
 Hinterleger: Roland Stahel, Pflugsteinstrasse 37,  
 8703 Erlenbach ZH

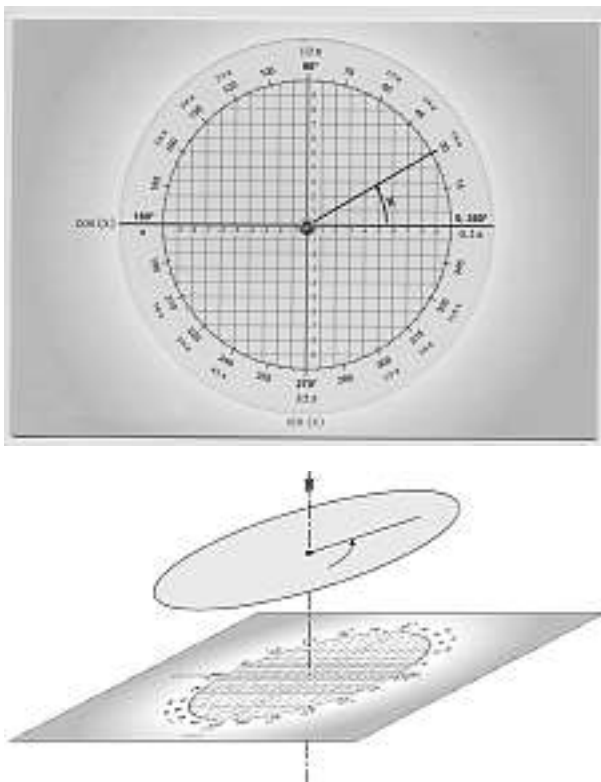

Rechenschieber

Cl. 20-02 **130 647** 02.04.2004  
 1 Design – Zeitschriftenablage  
 Hinterleger: Eurocyl AG, Industriestrasse 22, Postfach 114,  
 2545 Selzach  
 Designer: Arnulf Bohnacker, Oberdorf SO



10-00020

Cl. 21-01 **130 648** 01.04.2004  
 2 design – pièces de jeux  
 Déposant: Didier Vanbeneden,  
 1148 Chavannes-le-Veyron  
 Mandataire: ANDRE ROLAND IPS, 1001 Lausanne

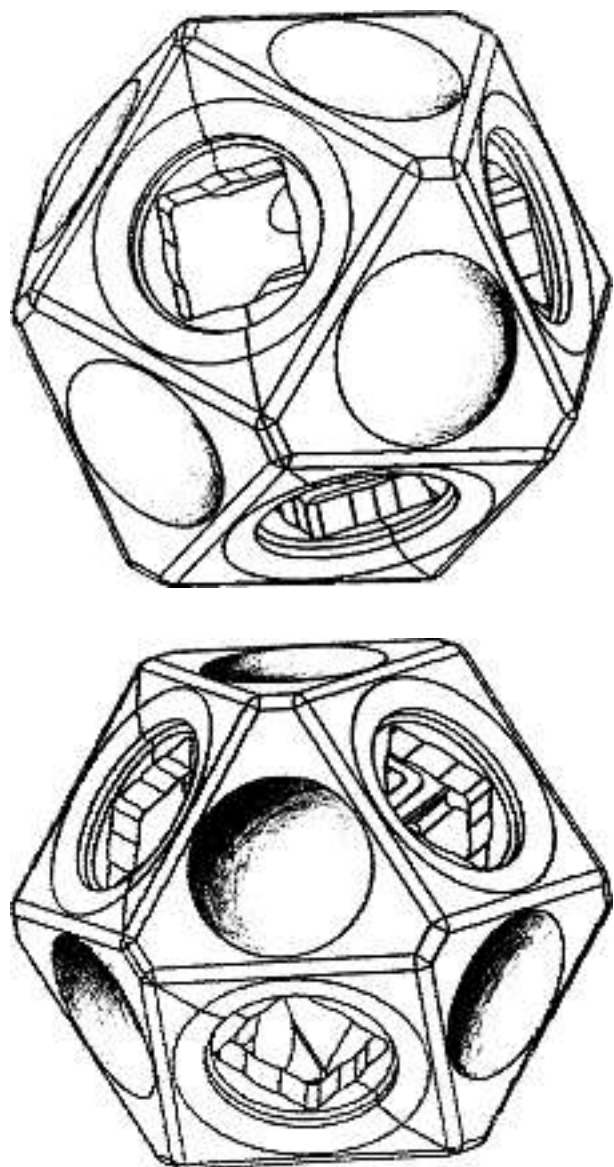

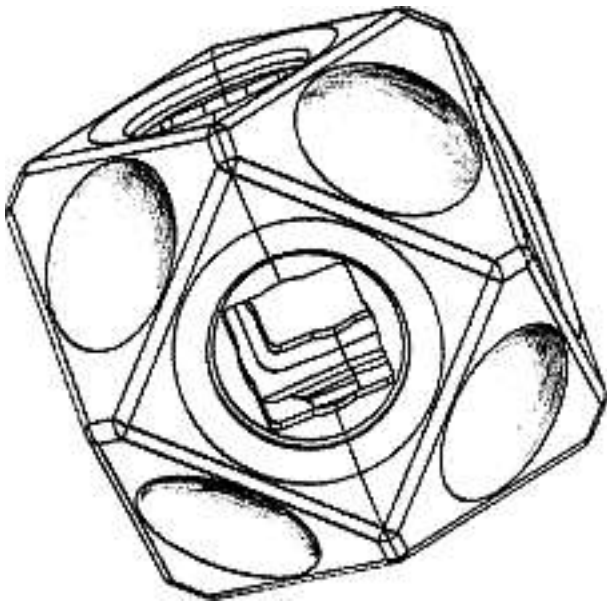

0307-002.D.CH-1

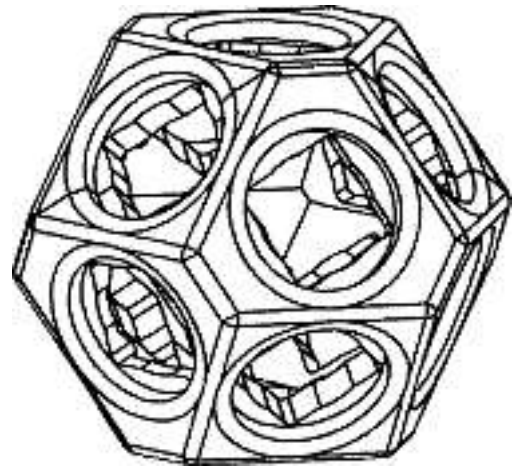

0307-002.D.CH-2

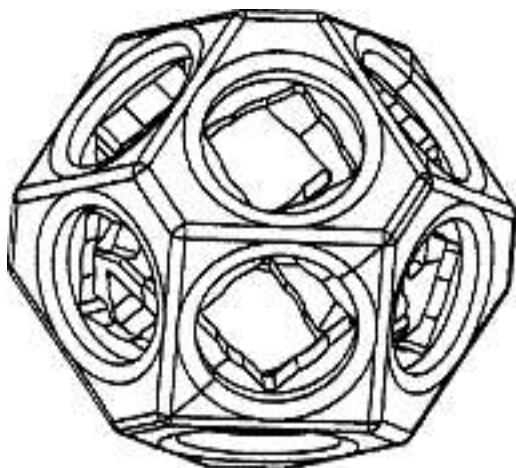
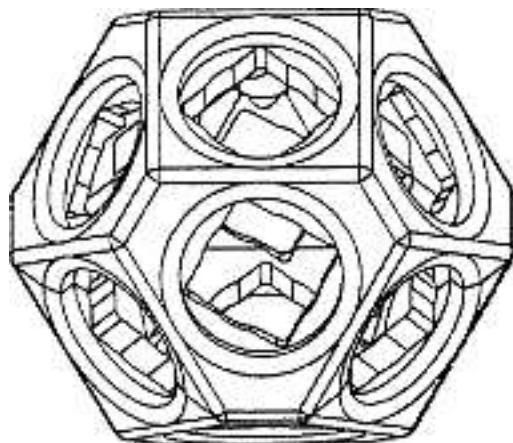

Cl. 21-01 **130 649** 05.04.2004  
 1 Design – Spiel  
 Hinterleger: Graziello Zanconi, Muot da Zünd 2,  
 7503 Samedan

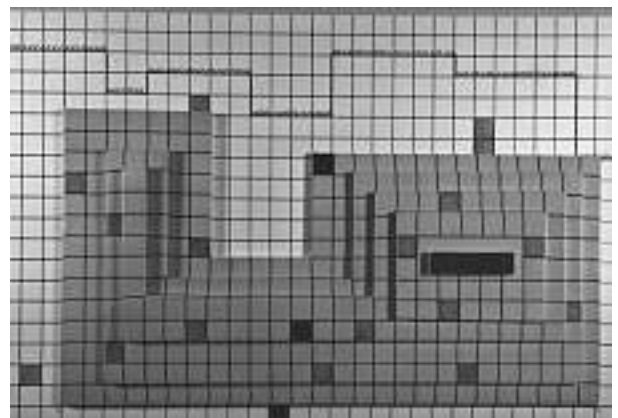
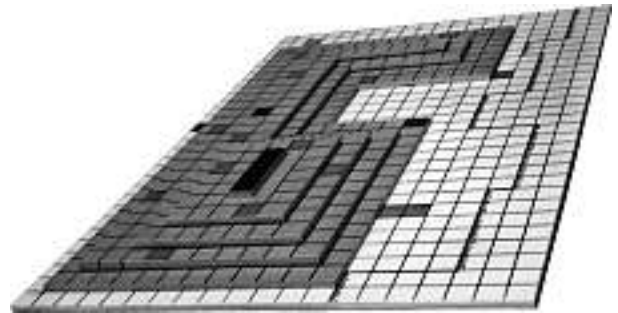

Sympathi

Cl. 21-02 **130 650** 14.04.2004  
 1 Design – Golf Zubehör  
 Hinterleger: Roffler GmbH, Neubüelstrasse 10, 8340 Hinwil  
 Designer: Werner Roffler, Hinwil

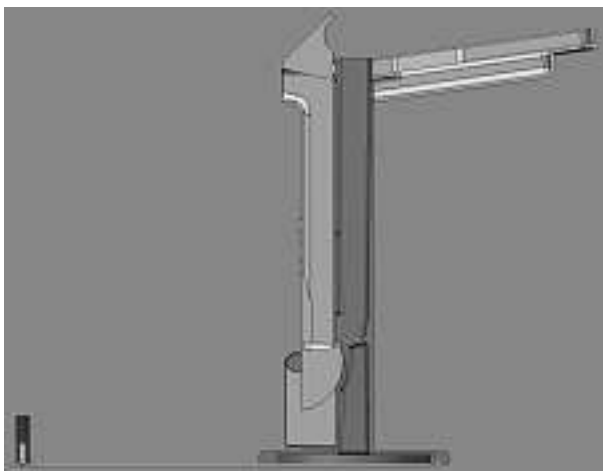
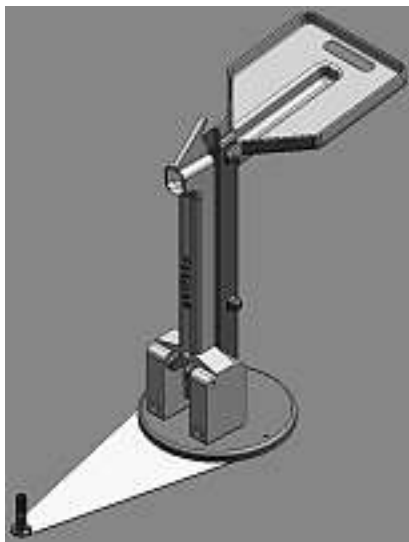
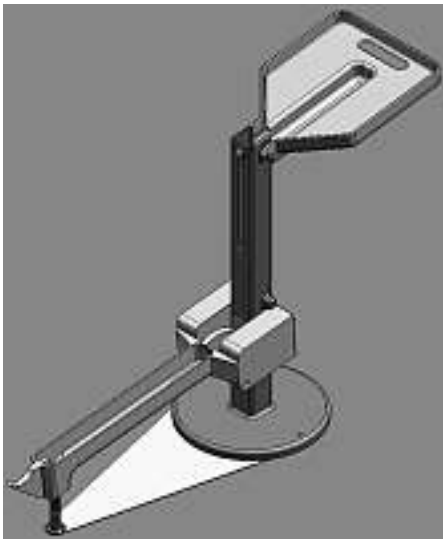

5565\_Z

Cl. 23-03                      **130 651**                      01.04.2004  
 1 Design – Ofen  
 Hinterleger: OFÄHUIS Pierre Nemitz, Kirchweg 5,  
 6375 Beckenried  
 Designer: Pierre Nemitz, Beckenried



1A

Cl. 23-03                      **130 652**                      05.04.2004  
 3 Design – Cheminée  
 Hinterleger: Manuel Candio, Hardturmstrasse 175, 8005 Zürich;  
 Ronald Büttler, Rotwandstrasse 64, 8004 Zürich  
 Vertreter: Manuel Candio, 8005 Zürich



Wandmodell



Unterbau



Arbeitsbereich

Cl. 26-05                      **130 655**                      19.04.2004  
 1 Design – Beleuchtungskörper  
 Hinterleger: iGUZZINI ILLUMINAZIONE S.r.l., SS 77, Km 102,  
 Recanati, IT  
 Designer: Giannunzio Guzzini, Recanati  
 Vertreter: Bovard AG, 3000 Bern 25  
 Priorität: EM, 22.10.2003

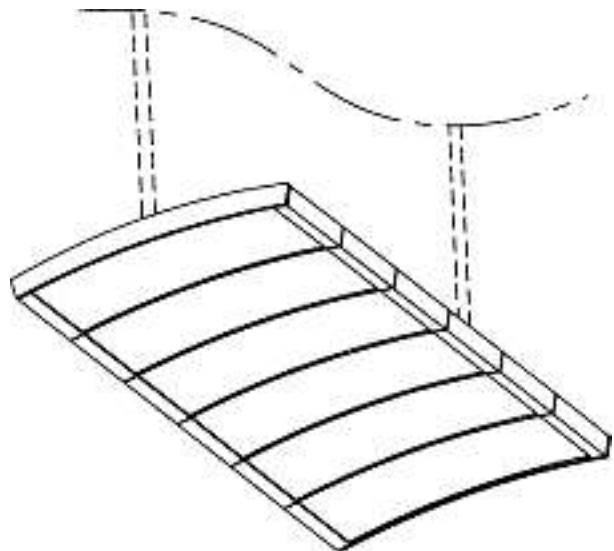
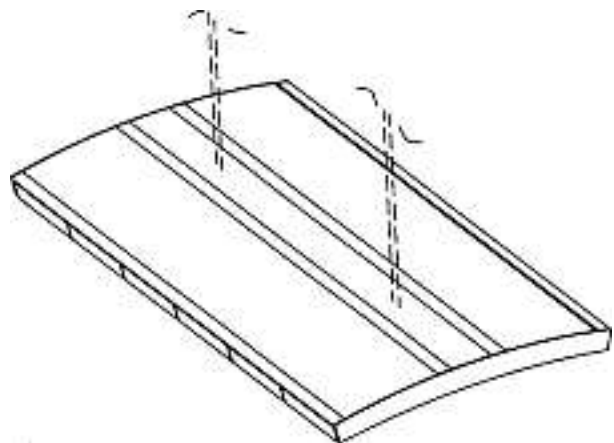
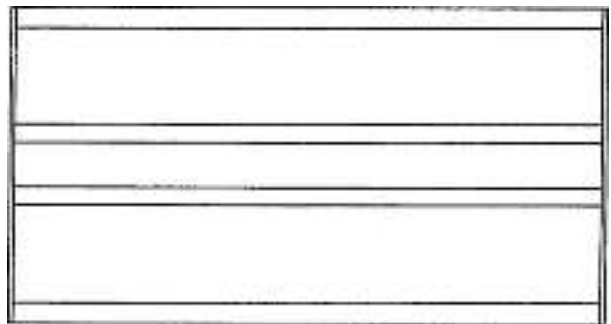
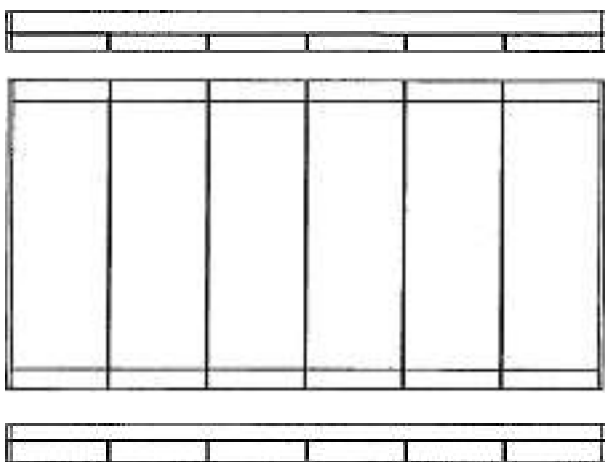

300387

Cl. 30-06 130 656 08.04.2004  
1 Design – Tierbett  
Hinterleger: Mars, Incorporated, A Delaware Corporation,  
6885 Elm Street, McLean/VA, US  
Designer: David Wylie, Hebden Bridge  
Vertreter: A.W. Metz & Co. AG, 8024 Zürich  
Priorität: EM, 11.02.2004

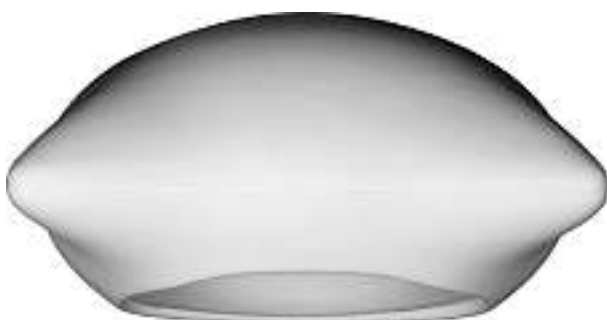
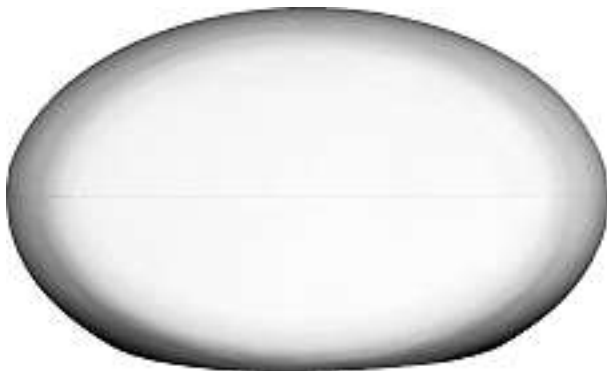

50896-CH-30-DC

# Verlängerungen Prolongations Prolongazioni

117 276 Cl. 09-05 5 Design



1



3



4



2



5





117 335 Cl. 07-03 1 Design



1/89

117 470 Cl. 09-03 2 Design



1



2

117 527 Cl. 02-04 2 design



1





2

121 330	Cl.	09-03	1 Design
121 374	Cl.	07-01	1 Design
121 376	Cl.	07-04	1 Design
121 426	Cl.	19-06	1 Design
121 427	Cl.	19-06	1 Design
121 435	Cl.	22-03	1 Design
121 502	Cl.	09-02	3 design
121 562	Cl.	09-01	2 Design
121 573	Cl.	12-11	1 Design
121 585	Cl.	23-03	2 design
121 645	Cl.	09-03	2 Design
121 664	Cl.	20-02	1 Design
121 758	Cl.	06-03	1 Design
125 568	Cl.	08-03	1 Design
125 873	Cl.	06-04	22 Design
125 996	Cl.	10-05	1 Design
126 064	Cl.	07-06	1 Design
126 098	Cl.	07-01	1 Design
126 109	Cl.	10-06	2 Design
126 119	Cl.	15-99	1 Design
126 130	Cl.	21-01	1 Design
126 143	Cl.	03-01	1 Design
126 160	Cl.	12-15	1 Design
126 179	Cl.	06-04	6 Design
126 186	Cl.	07-06	3 Design
126 188	Cl.	09-01	1 Design
126 202	Cl.	19-02	2 Design
126 206	Cl.	21-02	1 Design
126 227	Cl.	08-05	10 Design
126 263	Cl.	06-01	1 Design
126 276	Cl.	10-03	1 Design
126 286	Cl.	15-99	1 Design
126 329	Cl.	28-03	1 Design
126 334	Cl.	06-01	1 Design
126 349	Cl.	10-07	1 design
126 350	Cl.	10-07	1 design
126 376	Cl.	25-02	1 Design
126 382	Cl.	06-03	21 Design
126 423	Cl.	12-08	2 Design
126 425	Cl.	13-03	1 Design
126 462	Cl.	14-01	1 Design

## Mutationen Modifications Modificazioni

128 787

Übertragung

Hinterleger: Fritz Müller Metallwarenfabrik GmbH,  
Döinghauser Strasse 37, Schwelm, DE;Vertreter: Troller Hitz Troller & Partner, Rechtsanwälte,  
6002 Luzern

## Löschungen Radiations Radiazioni

117 011	Cl.	12-08	1 Design
117 047	Cl.	25-01	1 Design
117 056	Cl.	10-01	1 design
117 070	Cl.	99-00	10 Design
120 905	Cl.	01-03	1 Design
120 906	Cl.	02-02	1 Design
120 908	Cl.	04-02	1 Design
120 910	Cl.	06-01	1 Design
120 912	Cl.	06-03	2 Design
120 915	Cl.	06-04	1 Design
120 916	Cl.	06-04	1 Design
120 925	Cl.	09-02	2 Design
120 959	Cl.	24-02	2 design
121 023	Cl.	15-07	1 Design
121 040	Cl.	10-04	1 Design
121 041	Cl.	10-04	1 Design
125 517	Cl.	02-04	3 Design
125 533	Cl.	10-02	3 Design
125 539	Cl.	11-02	1 Design
125 552	Cl.	25-01	1 Design
125 554	Cl.	02-07	2 design
125 555	Cl.	03-01	3 Design
125 559	Cl.	06-01	2 Design
125 560	Cl.	06-01	3 Design
125 561	Cl.	06-01	2 Design
125 562	Cl.	06-01	1 Design
125 563	Cl.	06-01	1 Design
125 565	Cl.	06-01	1 Design
125 569	Cl.	08-05	1 Design
125 574	Cl.	10-02	2 design
125 575	Cl.	10-02	2 design
125 576	Cl.	10-02	2 design
125 578	Cl.	10-07	9 Design
125 579	Cl.	10-07	2 Design
125 582	Cl.	11-01	32 Design
125 587	Cl.	14-03	5 Design
125 588	Cl.	14-03	1 Design
125 590	Cl.	15-07	3 Design
125 595	Cl.	26-01	2 Design
125 598	Cl.	01-01	4 Design
125 610	Cl.	09-07	9 Design